



Product Catalogue | 2015

Earthing & lightning protection Total solution catalogue

furse 

Power and productivity
for a better world™ 

Earthing & lightning protection

Total solution catalogue

Brand introduction	1
Introduction to lightning protection	2
Conductors	3
Air termination	4
Conductor network	5
Introduction to earthing	6
Earth electrodes	7
Earth bonds & clamps	8
FurseWELD	9
Introduction to electronic systems protection	10
Mains power protection	11
Data & signal protection	12
Telecoms & computer line protection	13
Specific systems protection	14
Protector accessories	15
Technical reference	16
Index	17

Introduction

Introduction

Furze overview - Our reach & expertise	1/2
Earthing & lightning protection - A real & significant threat	1/3
External lightning protection	1/4
Electronic systems protection	1/5
The Furze Total Solution approach	1/6
Technical advice, support & design services	1/8
Seminars & product training	1/9
Technical guides & software	1/10
Project references - where we make a difference	1/11
Key markets - World leading solution to earthing & lightning protection	1/12

Furse overview

Our reach & expertise

1

With over 120 years of experience Furse provide world leading Earthing, Lightning and Electronic Systems Protection solutions. From our own designed and manufactured products, through to risk assessment and systems design advice, Furse offer a renowned Total Solution for earthing and lightning protection.

Furse was acquired by the ABB Group in 2012, and through the wider distributor network they offer, the Furse brand has now become established as a world leader in earthing and lightning protection, with our products specified and installed in many prestigious projects globally.

The combined expertise of Furse and the experience within the electrical sector ABB provide, allows us to share the knowledge we hold in key industry sectors with our clients. In turn this promotes properly informed decision making on the best earthing and lightning protection solution to suit your needs.

Why use Furse?

Expertise

Specialist advice from our fully qualified technical engineers - focusing on your earthing and lightning protection issues and concerns.

Experience

Providing the optimum design - one that doesn't use more material than is necessary, saving you money.

Products

Our knowledge of the latest products ensures a tailored design that can be installed using the most appropriate and up-to-date products.

Technical

With over 120 years accumulated knowledge of developing earthing and lightning protection solutions, we provide design systems to any recognized standard.

Customer service

Our sales and technical teams are ready to assist with all your earthing and lightning protection needs.

Knowledge

Our knowledge of the latest standards ensures designs and selected products comply with the latest IEC/BS EN/NFPA/UL standards.



Earthing & lightning protection

A real & significant threat

Lightning is one of nature's most powerful and destructive phenomena. Lightning strikes present a real and significant threat to life, to the structures in which we live and work, and to the electronic systems which support us in our daily lives.

Lightning contains awesome amounts of electrical energy. Lightning discharges have been measured from several thousand to over 200,000 Amps (enough to light half a million 100 Watt bulbs) and even though of a very short duration, can cause tremendous damage and destruction.

The consequences of lightning can be devastating:

- Direct lightning strikes damage structures, and create fire, explosion and electric shock hazards.
- Indirect lightning (up to a kilometre away) creates transient overvoltages which degrade electronic systems and disrupt essential services.

Secondary effects of lightning

The effects of a direct strike are obvious and immediately apparent - buildings damaged, trees blown apart, personal injuries and even loss of life.

However, the secondary effects of lightning - the short duration, high voltage spikes called transient overvoltages - can, and do, cause equally catastrophic, if less visually obvious, damage to electronic systems within structures.

The need for a Total Solution

Lightning protection throughout the world is now governed by National and International standards which stress the need for a comprehensive solution. Simply put, a structural lightning protection system cannot and will not protect electronic systems from lightning currents and transient overvoltages, that's why we advocate a Total Solution to earthing and lightning protection. This approach to lightning protection is now fully endorsed by the IEC/BS EN 62305, as well as NFPA 780 standards.

Therefore the Furse approach delivers effective life safety, together with long lasting, reliable protection of a structure and the electronic systems within. We believe the Furse Total Solution is the best available solution for achieving effective, dependable, long term lightning protection and earthing.

Protecting against the consequences of lightning is now of paramount importance in any building design, our Total Solution covers a wide range of sectors, for which we have tailored products and services.

Furse products and services are tailored to cover a wide range of industry sectors

1 Datacentres | 2 Trackside substations | 3 Wind farms | 4 Oil & Gas | 5 Water treatment | 6 Telecommunications | 7 Healthcare | 8 Substations



Introduction

External lightning protection

1



The function of an external lightning protection system is to intercept, conduct and disperse a lightning strike safely to earth.

Ensuring effective external protection

Lightning can cause fires, explosions, chemical release or mechanical disruption within or around a structure.

Step and touch voltages generated from a lightning strike can cause injury, or even loss of life.

Critical services, such as mains power and telecoms etc., can be heavily disrupted, resulting in major potential losses. Offices risk physical damage to servers and PCs, as well as loss of key data; factories risk machinery downtime and repair costs along with health and safety hazard to personnel.

The Furse Total Solution takes account of all the potential risks from a direct lightning strike, and incorporates all the elements necessary to deliver full and effective external lightning protection, including:

- Structural lightning protection
- Earth termination
- Equipotential bonding of metallic parts

Structural lightning protection

A structural lightning protection system is designed to protect the fabric of a structure and the lives of people inside by channelling lightning strike energy in a safe and controlled manner to the earth termination network.

Earth termination

The earth termination network connects to the down conductor network at the base of the building, and is the means through which the lightning current is dissipated to the general mass of earth.

Lightning equipotential bonding

Equipotential bonding is designed to ensure the risk of dangerous sparking or flashover occurring within a structure is avoided. It ensures no metallic part would be at a different potential to others in the event of lightning currents flowing in the system.

Earthing components must offer both a low resistance to earth and have excellent corrosion resistance, as they will be buried in the ground for many years.

Direct bonding can be achieved through earthing components, or for service lines with 'live cores', through installation of Furse ESP lightning current/equipotential bonding SPDs.

Introduction

Electronic systems protection



IEC/BS EN 62305 makes clear the need for a combined lightning protection solution including both structural and electronic systems protection.

Electronic systems have become central to virtually every aspect of our lives from PCs and building management systems in the office to automated petrol pumps and barcode scanners at the supermarket.

The ever-changing pace of technological development, and especially the headlong quest for miniaturisation, has created the scenario where increasingly lightning sensitive systems are placed at the core of our society.

Most modern electronic systems are at risk including computers, data communication networks, CCTV equipment, plant sensors, programmable logic controllers (PLCs), even uninterruptible power supplies (UPSs).

The seriousness of the consequences of that damage, are more real than ever before.

The importance of electronic systems protection, often referred to as surge protection, is now defined in many standards, including IEC/BS EN 62305 and BS 7671.

Transient overvoltages

The main risk to internal systems is through transient overvoltages - large, very brief and potentially destructive increases in voltage within the electrical system.

Transient overvoltages can be caused by:

- The secondary effects of lightning strikes (either between clouds or to ground) from up to a kilometer away, from lightning energy induced on to power, data and signal lines
- Electrical switching of large inductive loads (such as motors, transformers and electrical drives)

Devastating effects

Transient overvoltages can reach magnitudes of up to 6,000 Volts in a well-insulated 230/400 V power distribution system, over eight times the level tolerated by many electronic systems. Although lasting only thousandths or millionths of a second, without protection they can devastate modern electronic systems.

Loss of these systems would cripple industrial, commercial and government organizations alike.

Introduction

The Furse Total Solution approach

1. Structural lightning protection

From Furse air termination systems including air rods and strike plates to capture lightning strikes, through to our comprehensive range of down conductors and lightning protection components which channel lightning energy safely to a Furse earth termination network.

Including:

- Air termination systems
- Lightning protection conductors
- Conductor clips, clamps & holdfasts
- Bimetallic connection components

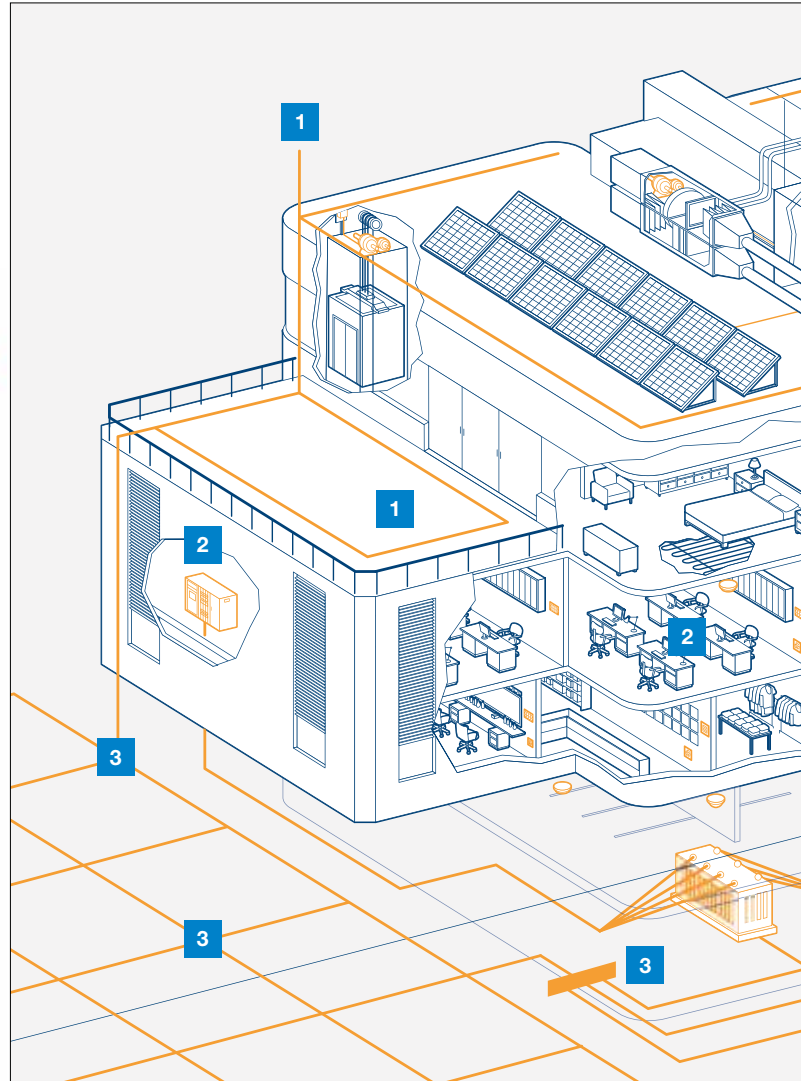
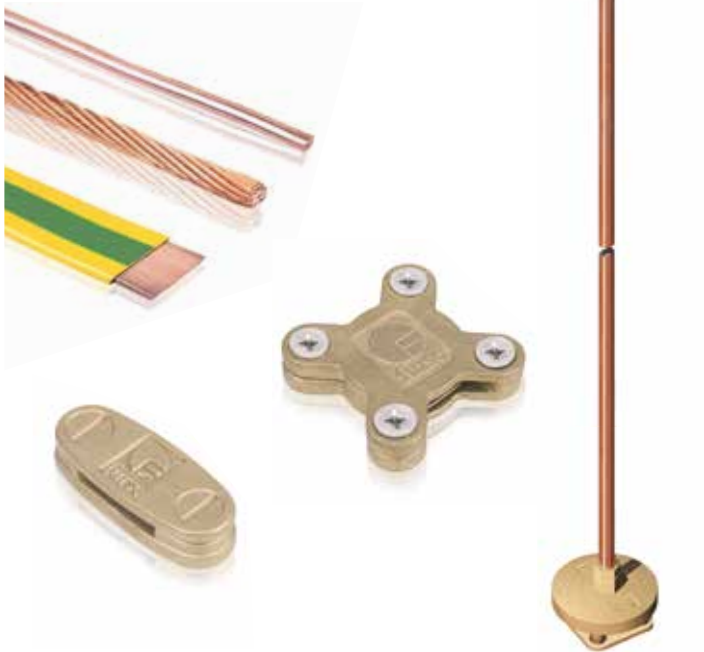

1 Structural lightning protection | 2 Electronic systems protection | 3 Earthing

2. Electronic systems protection

Our extensive range of equipotential bonding and transient overvoltage Surge Protection Devices (SPDs) providing fully coordinated protection against transient overvoltages. SPDs are able to cover all incoming and outgoing metallic service lines including power, data, signal and telecoms.

Including:

- Lightning equipotential bonding SPDs
- Mains power transient overvoltage SPDs
- Data, signal & telecommunication lines SPDs
- DC power & photovoltaic system SPDs



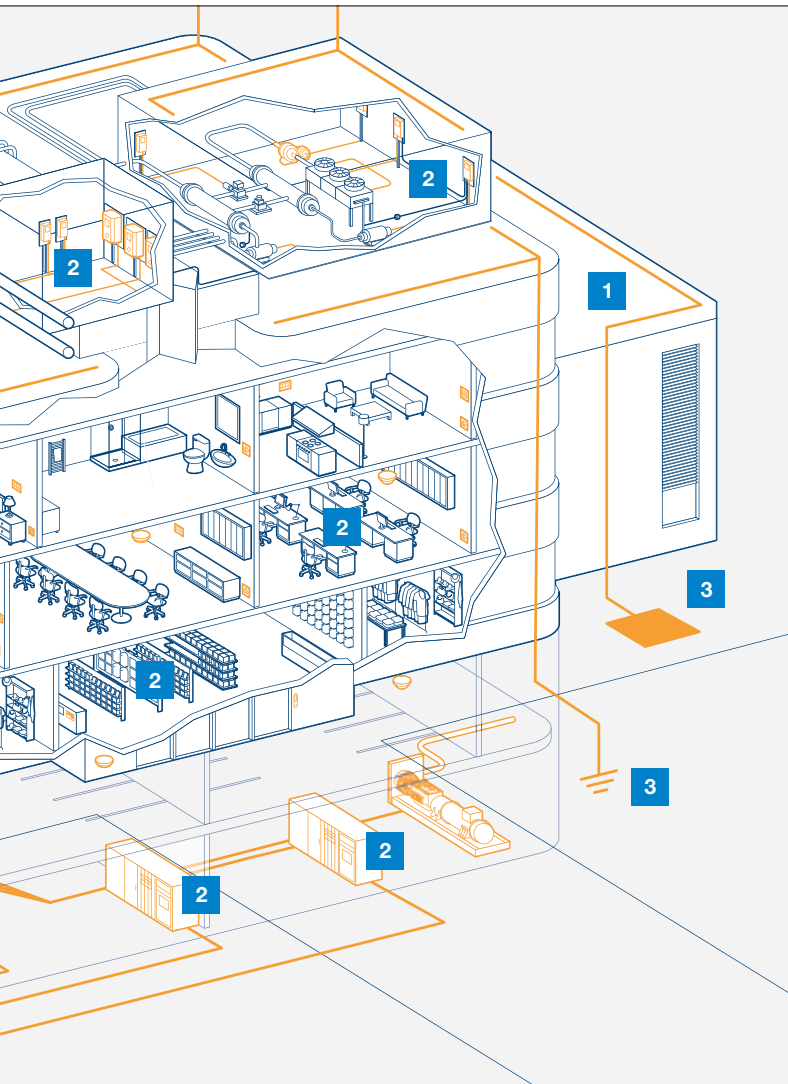

3. Earthing

The combination of Furse earth electrodes, clamps, conductors and equipotential bonding bars which provide lightning and transient overvoltage energy with an effective, low resistance route from lightning protection system to earth.

Including:

- Earth rods & conductor systems
- Mechanical earth clamps & bonds
- FurseWELD exothermic welding
- Earth bars & equipotential bonding



4. Design and technical support

Furse technical design teams ensure all designs for lightning protection, earthing and transient overvoltage protection meet relevant National and International standards, whilst our sales engineers provide key updates on lightning protection matters.

Including:

- Lightning protection system design
- Site surveys & earthing analysis
- Lightning protection seminars & training
- Technical guides & StrikeRisk software



Introduction

Technical advice, support & design services

1

Sharing knowledge and expertise with our customers has been a fundamental ingredient to the success of our Total Solution approach to earthing and lightning protection.



1 Lightning protection solutions | 2 Soil resistivity surveys | 3 Analysis & earthing design | 4 Earth resistance testing

1. Lightning protection solutions

- Team of experienced engineers
- Engineered designs to meet client specifications
- Risk assessment complying to latest standards

2. Soil resistivity surveys

- Experienced surveyors
- Key to creating effective earthing system
- Multiple readings taken to ensure safe and accurate designs

3. Analysis & earthing design

- Latest CDEGS software to optimize designs
- Range of detailed reports to clients requirements

4. Earth resistance testing

- Verification of earthing design through measurement
- Experienced team of engineers with full understanding of electrode testing

Lightning protection & earthing design

In order for us to design a structural and/or transient over-voltage lightning protection system, we need the following information:

- Design standard, e.g. IEC/BS EN 62305, NFPA 780, etc.
- A dimensioned roof plan and external elevations
- Construction details, e.g. steelwork, reinforced concrete, roofing materials, etc
- A single line diagram indicating voltage and current for each electrical system, e.g. power, data, telephones, fire alarms, CCTV
- Details of essential equipment, e.g. network servers, PLC controllers

To design a power earth electrode system, we need the following information:

- Design standard, e.g. BS 7430, BS 7354, Ansi IEEE Std 80, ENA TS 41-24, etc.
- A dimensioned site plan and overall electrical single line diagram
- Soil resistivity survey results
- Earth fault current magnitude (due consideration should be

given to the proportion of current flowing through cable sheaths or the aerial earth wires of overhead transmission lines)

- Earth fault current duration

Customer site surveys

Site surveys fully complement our in-house design services. Through collation of all relevant information from a site, including soil resistivity measurements and earthing analysis, our engineers can produce bespoke earthing designs complete with drawings, calculations and a detailed report, along with a structural lightning protection system if required.

The benefits of coming to Furse

There are many benefits of coming to Furse for earthing, lightning and electronic systems protection designs, including:

- Specialist advice from a fully qualified technical team
- Designs that comply with all relevant standards
- Our responsibility for providing a design that is safe
- Experience and the software to provide an 'optimum' design
- Manufacturing experience & expertise
- Engineers who actively participate in the development of National and International standards

Introduction

Seminars & product training



1

We offer regular CIBSE CPD accredited training seminars to improve understanding of earthing, lightning and transient overvoltage protection standards and practices.

Lightning protection is a progressive industry underpinned by an adherence to British, European and International standards.

These National and International standards are regularly updated making it important to keep abreast of latest developments.

Given the complexity of the standards, confusion and misinterpretation can easily lead to project delays, budget overruns and costly extra time on site. We aim to help customers avoid these risks, fully supporting Furse product ranges with high quality technical support services.

We're here to help

We have tailored a range of support and training solutions to help our customers acquire a greater understanding of earthing, lightning and transient overvoltage protection, and thereby to help clarify the IEC/BS EN 62305 standards.

Seminars are held at the local ABB Furse Nottingham office, other convenient locations and customer premises - please contact us for further information.



Seminars and training

We undertake regular CIBSE CPD accredited training seminars to improve understanding of lightning and transient overvoltage protection.

Seminar topics include:

- **Overview of IEC/BS EN 62305**
- **Electronic systems protection to IEC/BS EN 62305**
- **Overvoltage protection to BS 7671**

We also cover selection and installation of Surge Protective Devices as appropriate to meet Section 534 of BS 7671, to achieve a satisfactory electrical installation.

Introduction

Technical guides & software

1



StrikeRisk risk management software

For consultants and designers looking to undertake their own risk assessments, the Furse technical team has developed StrikeRisk.

StrikeRisk is an invaluable tool which automates the complex risk assessment calculations required by IEC/BS EN 62305-2. Quick and easy to use, with full reporting capability, StrikeRisk has been devised to deliver results in minutes, rather than the hours or days it would take to do the same calculations by hand. This software makes light of the trial and error calculations required by IEC/BS EN 62305-2, which would otherwise prove onerous if attempted manually.

StrikeRisk version 6.0 is now available. This version enables calculation to the latest edition of the IEC/BS EN 62305-2, through selection of the relevant national template. Available as a free 15 day trial, the software also includes a range of purchase and upgrade options, to suit customer needs for both a networked or standalone PC solution.

Technical guides

A wide range of product datasheets, technical guides and software is available to help you improve your understanding of lightning protection. Please visit our website or contact us directly for more information.

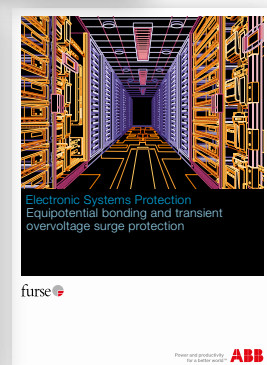
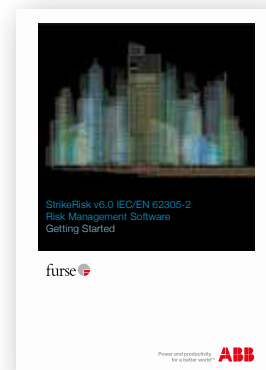

Project references

Where we make a difference



1 Bank of England, UK | 2 Channel Tunnel Rail Link, UK | 3 Canary Wharf, London, UK | 4 Circle Line, Mass Rapid Transit System, Singapore
5 Heathrow Airport, London, UK | 6 Kuala Lumpur Stock Exchange, Malaysia | 7 Manchester United Training Ground, UK | 8 Financial Towers, Bahrain

Our Total Solution approach, which delivers innovative, high quality products supported by intelligent, concise technical support, makes Furse the brand of choice for many projects, in many markets, worldwide.

Oil & gas / Petrochemical

- Oil Fields in Toha, China
- Pertamina Gas / Petrol Depot, Indonesia
- Asab Full Field Development, UAE
- Dorra Gas Field Development, Saudi Arabia
- Jubail Chevron Phillips (JCP)
- Petrochemical Plant, Saudi Arabia

Utilities

- Waste Water Treatment Plant, Shoiba, Saudi Arabia
- JAFZA Desalination Plant, UAE
- Hammas Power Station, Algeria
- Shuwaikh Desalination Plant, Kuwait
- Tianwan Nuclear Power Plant, China
- Mombassa Substation, Kenya
- Kapichira Hydro-Power Station, Malawi

Rail & infrastructure

- Bahrain Int'l Airport Expansion
- Shanghai Metro, China
- Kowloon Rail Link, Hong Kong
- New Terminal, Seeb Airport, Oman
- Circle Line, Mass Rapid Transit System, Singapore
- Channel Tunnel Rail Link, UK

High tech & industrial

- Taiwan Semiconductor Manufacturing Corporation, China
- China Telecom
- Intel Plant, High Tech Kulim, Malaysia
- Kuala Lumpur Telecoms Tower, Malaysia
- Seagate Semiconductor Plant, Singapore
- Alexandra Technopark, Singapore
- Motorola Factories, Singapore
- Najran Cement Factory, Saudi Arabia
- Merck, Sharp & Dohme Pharmaceutical Plant, Singapore
- Alfred McAlpine Quarry Products, UK

Commercial construction

- Bahrain Financial Harbour
- Emirates Towers, Bahrain
- Petronas Twin Towers, Malaysia
- Oman Arab Bank, Oman
- Kuala Lumpur Stock Exchange, Malaysia
- Graha Energy Building, Indonesia
- Canary Wharf, London, UK
- Highland Distilleries Co plc, UK
- Barwa Financial District, Qatar
- London Stock Exchange
- Royal Bank of Scotland

Sports & recreation

- MGM Grand Hotel & Complex, Macau, China
- Bahrain Opera House
- Azizia Mall, Kuwait
- Disneyland Hong Kong
- Sebang International Formula One Circuit, Malaysia
- Manchester United Training Ground, UK
- Grand Plaza Hotel, Singapore
- Dubai Sports City Complex, UAE

Government & public sector

- Royal College of Surgeons, Muharraq, Bahrain
- Ministry of Foreign Affairs, Brunei
- Singapore Embassy, China
- Prime Minister's Office, Putrajaya, Malaysia
- University Institute of Technology, Ijok-Selangor, Malaysia
- Ministry of Finance Administrative Building, Malaysia
- Mater Dei General Hospital, Malta
- International Maritime College, Oman
- Al Jaber Hospital, Kuwait
- British Library, London, UK

Key markets

World-leading solution to earthing & lightning protection

1

For all our customers, the Furse Total Solution approach to earthing & lightning protection is the leading solution for all project types worldwide.

Oil & gas / petrochemical

- Offshore platforms & oil fields
- Gas & oil refineries
- Pipelines
- Petrochemical processing

1 Oil & gas / petrochemical | 2 Renewable energies | 3 Cultural & heritage | 4 High tech & industrial
5 Sports & recreation | 6 Government & public sector | 7 Utilities | 8 Rail & infrastructure | 9 Residential | 10 Commercial construction

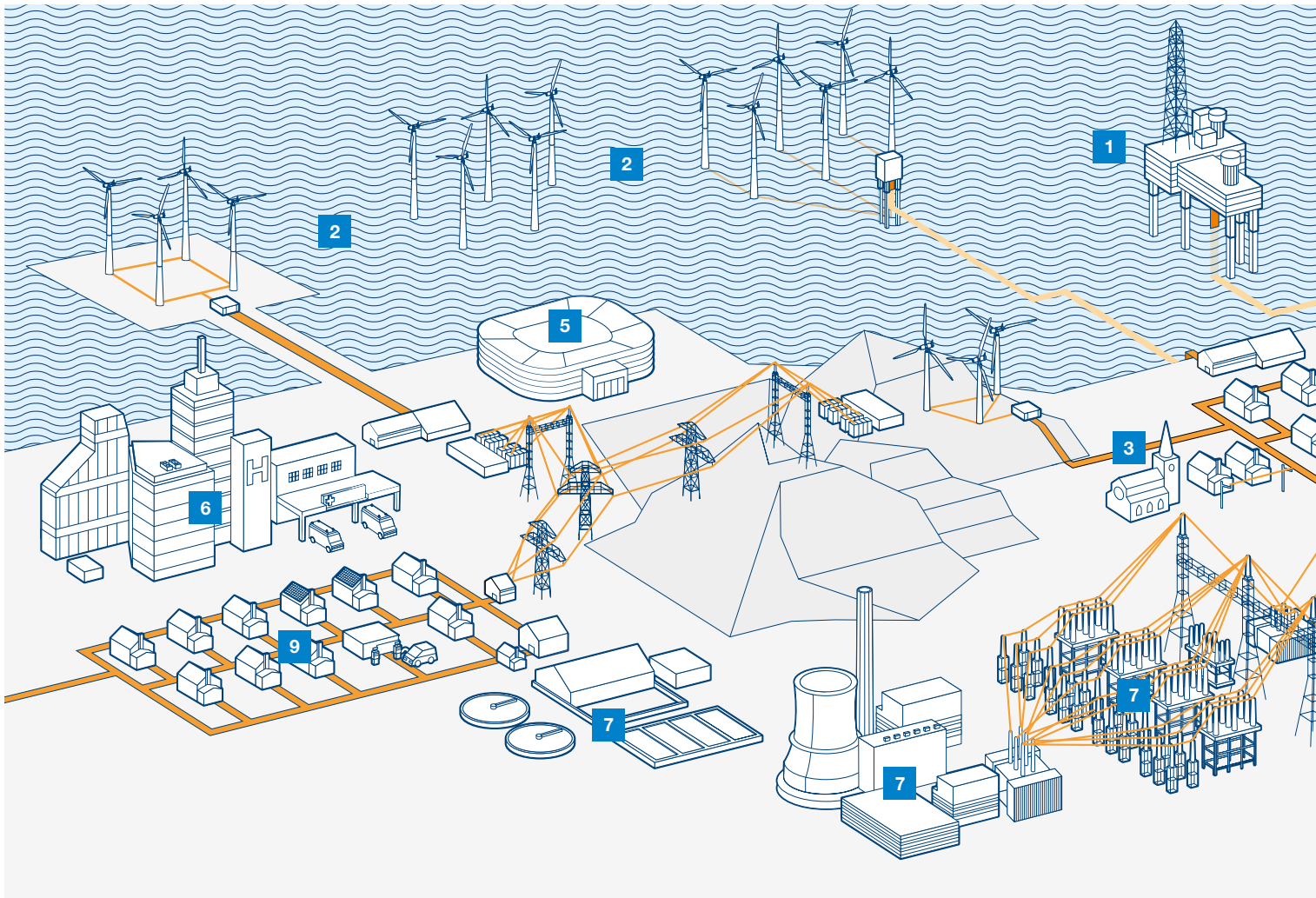

Renewable energies

- Solar / PV farms
- Windturbines
- Hydro-power stations

Cultural & heritage

- Historical sites
- Mosques, churches & cathedrals
- National libraries
- Monuments

High tech & industrial

- Pharmaceutical factories
- High-tech manufacturing & semiconductor plants
- Telecoms stations, exchanges & transmission towers
- IT Parks & technoparks
- Heavy industry including steel, cement, glass fibre & synthetics

Sports & recreation

- Hotels & resorts
- Sports facilities & training grounds
- Theatres & opera houses
- Shopping malls

Utilities

- Power stations (coal, gas, nuclear)
- Electricity substations
- Overhead transmission lines
- Waste water treatment facilities
- Desalination plants

Government & public sector

- Central government buildings
- Embassies & official residences
- Local authority premises
- Police stations
- Hospitals & healthcare facilities
- Technical colleges & universities

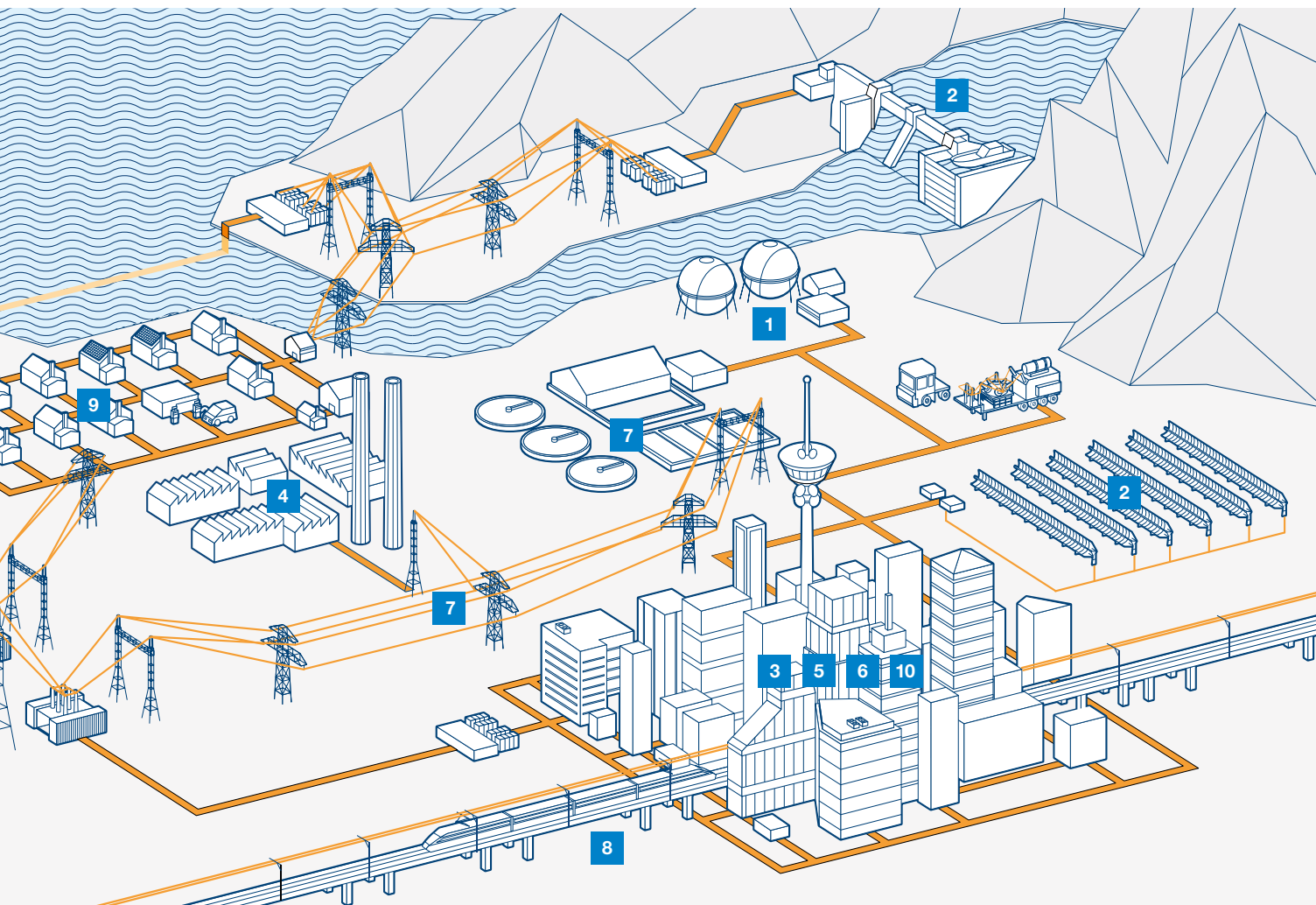

Rail & infrastructure

- National railways
- City metro & light rail systems
- Airports & airport terminal expansions
- Subsea tunnels

Residential

- High rise residential towers & apartment blocks
- Condominiums
- Housing development projects

Commercial construction

- Landmark commercial projects
- Financial services institutions
- Convention & exhibition centres
- Office blocks
- Stock exchanges & trade centres
- Commercial centres, showrooms & retail units

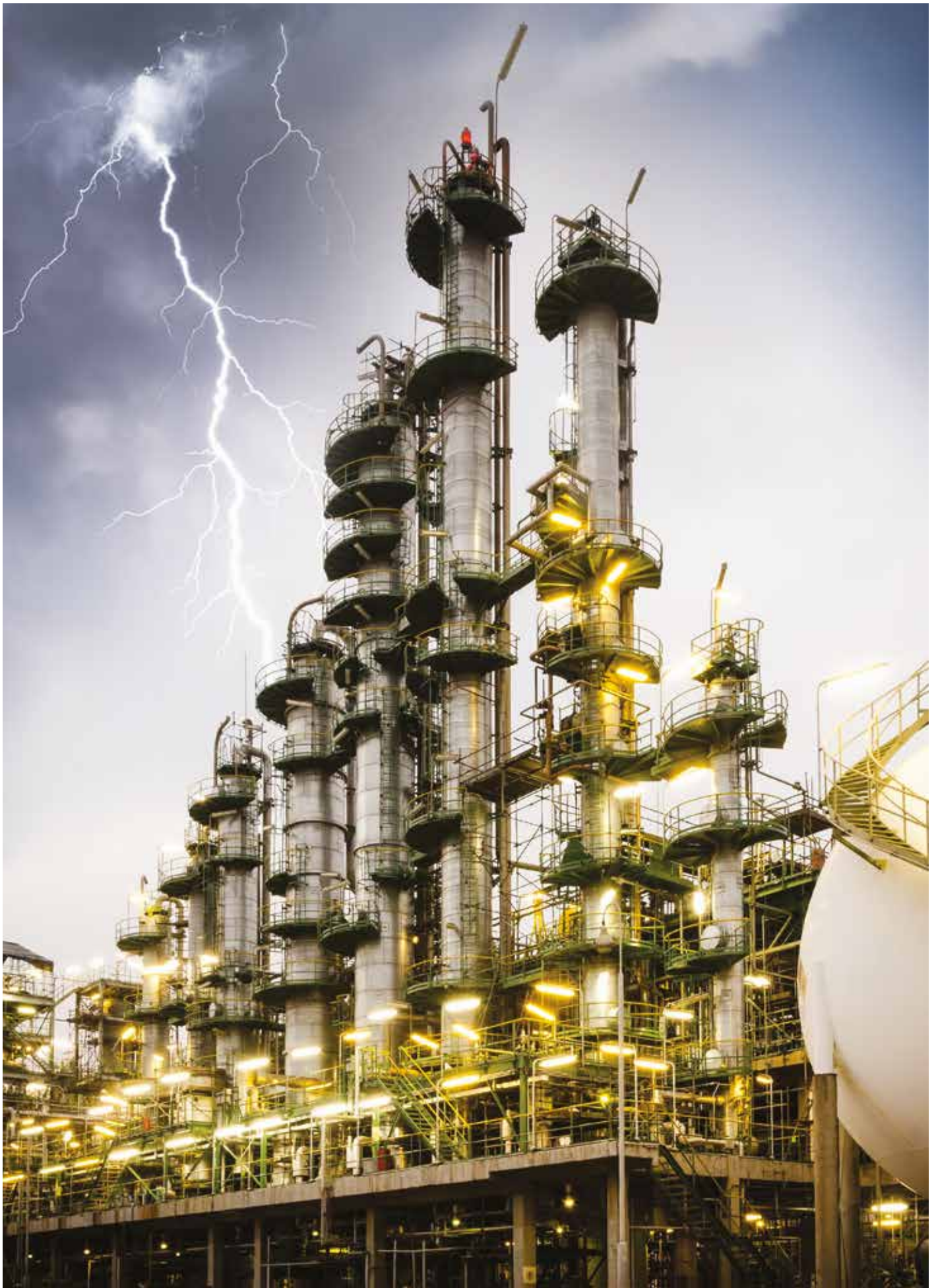

Introduction to lightning protection

Lightning Protection

Introduction to lightning protection	2/2
Product selection guide	2/4

Introduction to lightning protection

2



When designing a structural lightning protection system using the Faraday Cage principle advocated by IEC/BS EN 62305, it is possible to use one or more types of conductor, such as flat tape, solid circular or cable and wire (stranded).

The decision about which type to use is often based more on country-specific historical preferences or aesthetic considerations than the superiority of one type over another. High quality Furse conductors, plus appropriate fittings, are available for all three systems.

Flat tape conductor system

Flat tape conductors are easy to install, with no need to straighten for a neat finish. Available in copper or aluminium, flat tape can be installed bare or with a choice of PVC coverings, to enable the tape to blend with modern building fabrics.

Tinned copper tape is also available for applications that require additional protection measures, and copper braid is available for use where flexibility is necessary, e.g. on moving installations like gates or doors.

Furse copper tape is approved to BS EN 13601, whilst Furse aluminium tape is manufactured to BS EN 755-5.



Solid circular conductor system

Solid circular conductors can be used in applications where aesthetic considerations are important.

The 8 mm diameter solid circular range is less conspicuous than the flat tape system, and lends itself much better to being concealed. Available in copper or aluminium, solid circular conductors can also have PVC coverings.

A coil of circular conductor can be quickly installed, being easy to bend in any plane, and only needing a straightening tool to give a very neat finish.

Furse copper solid circular conductor is manufactured to BS EN 13601, whilst Furse aluminium solid circular conductor is manufactured to BS EN 755-5.



Stranded conductor system

The Furse range of soft drawn stranded conductors is available in copper, either bare or PVC insulated, and complies with the US standard NFPA 780.

Furse soft drawn stranded conductor is manufactured to BS EN 60228, whilst our PVC insulated stranded conductor is manufactured to BS EN 50525.

The Furse range of conductors is complemented by a complete range of fittings, including clips, clamps, holdfasts and bimetallic connectors.

Fittings are designed to conform to the IEC/BS EN 62561 series of product standards for lightning protection components, with those installed with the most common conductor types suitably tested.

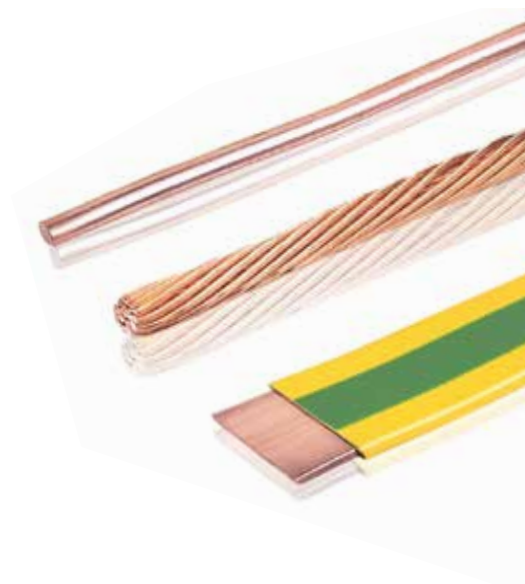

Introduction to lightning protection

Product selection guide

Product selection guide - Lightning protection

No.	Type	Section / Page No.
1.	Conductors	3/4
2.	Conductor fixings	5/2
3.	Air terminals	4/3
4.	Air rod bases	4/4, 4/11
5.	Conductor jointing clamps	5/16
6.	Test clamps	5/19
7.	Crossover conductor clamp	5/16
8.	Earth electrodes	7/3, 7/10
9.	Earth rod clamps	8/2
10.	Earth inspection pits	7/9
11.	Bonds	8/10
12.	Lightning current or equipotential bonding SPDs	11/3

Conductors

The first choice faced by the designer of a structural lightning protection system is the type of conductor system to be used:

- Choose the material required, i.e. copper or aluminium
- Choose the type of conductor required, i.e. flat tape, solid circular or stranded

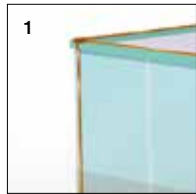

1. Conductor network

The conductor network is the means of intercepting/carrying the current of a lightning strike safely to the earth termination network. Use the guidelines of IEC/BS EN 62305-1 & -3 for the correct placement of conductors.

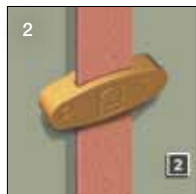

2. Fixings

Select the correct system of fixings for each part of the conductor system. Fixings are available for a wide range of modern construction materials, e.g. brick, stone, plastic and metal.

Air termination network

The air termination network is the point of connection for a lightning strike. It typically consists of a meshed conductor arrangement covering the roof of the structure. The mesh size is determined by Lightning Protection Level - LPL.

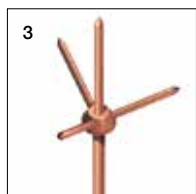

3. Air terminals

Use air terminals in the form of vertical air rods for the protection of prominent roof top features or equipment. Use strike pads to connect and thus expose concealed conductors.

Air termination network

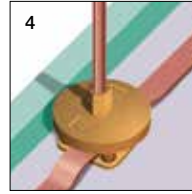

4. Air rod bases

Choose the correct air rod base. This will ensure that the vertical air rods are both solidly fixed to the fabric of the structure and have a low resistance connection to the conductor network.

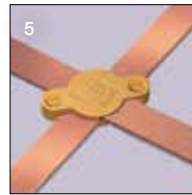

5. Interconnection components

Crossover clamps have been specially designed for use where conductors cross as part of a roof network.

Main aspects and individual components of an external lightning protection system

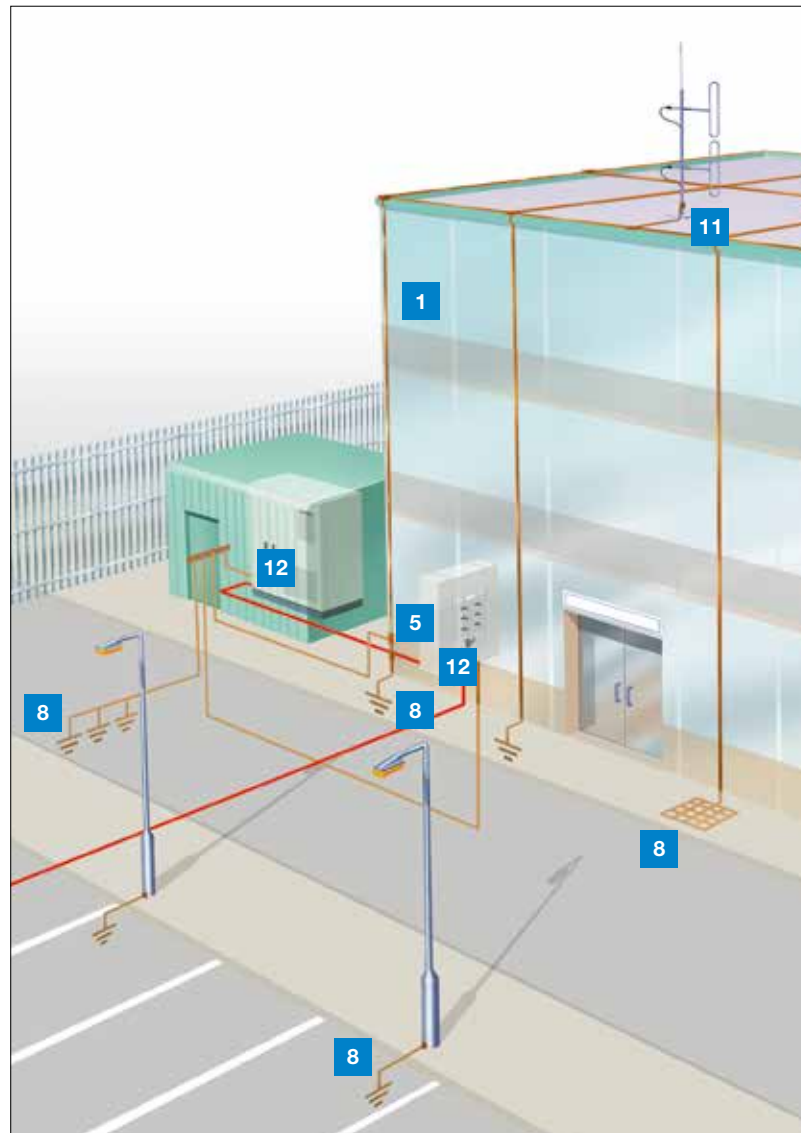

Down conductor network

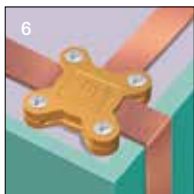

6. Conductor jointing clamps
Select a component for the interconnection of multiple conductors or for changes of direction. Jointing clamps will ensure a low resistance, corrosion resistant connection between air termination and down conductors.

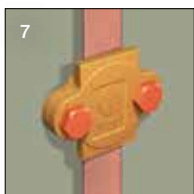

7. Test clamps
In order to allow periodic disconnection and testing of the earth termination network, select a test clamp to be placed within the run of each down conductor.

Earth termination network

The means of dissipating the current to the general mass of earth.

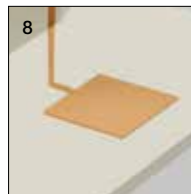

8. Earth electrodes
Choose an earth electrode to suit the system design i.e. Type A, Type B or foundation electrode. Electrodes can be constructed individually from earth rods, earth plates, flat tape, stranded cable or any combination of these.



9. Earth rod clamps
Select a high copper content alloy earth rod clamp for the connection of the earthing conductor to the earth rod. In this below ground application, the clamp must ensure a good electrical contact and resist corrosion throughout the lifetime of the installation.

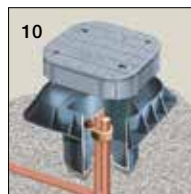

10. Earth inspection pits
Select an earth inspection pit to protect the earth electrode connections. High strength pits are available in plastic and concrete.

This illustration is designed to demonstrate the main aspects and individual components of an external lightning protection system. It is not intended to represent an actual scheme conforming to a particular code of practice. The drawing is not to scale.



Equipotential bonding

Bonding is the most commonly employed method of avoiding the damaging effects of side flashing. All continuous metalwork should be considered for bonding. All metallic services, e.g. cable armouring, gas, water or steam piping, entering the building should also be bonded as directly as possible to the earth termination network.



11. Bonds to metalwork
Select the correct type of metalwork bond for the application, i.e. a flat column face, a circular rainwater pipe or a ribbed reinforcing bar.

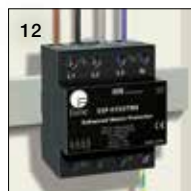

12. Equipotential bonding SPDs
Designed to prevent dangerous sparking caused by flashover, lightning current or equipotential bonding SPDs must be fitted to all metallic service lines with 'live cores' entering or leaving the structure.



Conductors

Conductors

Introduction	3/2
--------------	-----

Bare conductors

Bare copper tape	3/4
Bare aluminium tape	3/5
Bare solid circular	3/5

Bare stranded & tinned conductors

Bare stranded copper cable	3/6
Tinned copper tape	3/6

Bimetallic cable & hard drawn bar

Bimetallic cable	3/7
Hard drawn copper bar	3/7

Flexible braid

Flexible flat copper braid	3/8
Flexible circular copper braid	3/9

PVC covered conductors

PVC covered copper tape	3/10
PVC covered copper solid circular	3/10
PVC covered aluminium tape	3/11
PVC covered aluminium solid circular	3/11
Green & yellow PVC insulated copper tape	3/12
Green & yellow PVC insulated stranded copper cable	3/12

LSOH covered conductors

LSOH covered copper tape	3/13
--------------------------	------

Lead covered conductors

Lead covered copper tape	3/13
--------------------------	------

Conductor guards

PVC protective down conductor guard	3/14
Anti-vandal down conductor guard	3/14

Conductors

Introduction

By far the largest and most important component of any structural lightning protection or earthing system is the actual conductor.

Selection of the correct conductor type for the installation is highly important, and is likely to be the initial consideration of a lightning protection or earthing system designer.







3

A comprehensive range of Furse copper and aluminium conductors is available in each of the main globally recognized standard formats, i.e. flat tape, solid circular and stranded (note, copper stranded only). Additionally each format is available in a variety of conductor sizes, to meet differing lightning protection and earthing requirements.

Specification will depend on whether the application is for an above ground structural lightning protection system, or a below ground earthing installation.



Conductor colour chart

Colour	Standard	
Black	18B29*	
Green	BS 6746C	
Grey	00A07*	
Stone	08B23*	
White	10B15*	
Brown	06C39*	

*PVC colours to BS 5252

Conductors for structural lightning protection systems

Furse lightning protection conductors are available in copper and aluminium. Copper can be supplied bare, tinned, PVC, LSOH and lead covered. It is used for most installations due to its high conductivity, anticorrosive properties, and its flexibility for use in air, in earth and in concrete. Aluminium can be supplied bare or with PVC coating.

The following sizes are suitable for the majority of above ground lightning protection systems:

- **Flat tape conductor**
25 x 3 mm bare tape, or 25 x 3 mm PVC covered tape
- **Solid circular conductor**
8 mm diameter bare or PVC covered solid circular conductor
- **Stranded conductor**
70 mm² bare or PVC covered stranded conductor

Conductor colour chart

The choice of a lightning protection conductor is usually governed by its aesthetic impact on the structure to be protected. For many people the term lightning protection conductor conjures up an image of a discoloured copper strip running down the spire of a church. This would clearly be unacceptable to the owner/architect of a modern structure.

In order to reduce the impact of an external system Furse offer a range of UV stabilized PVC covered tapes and solid circular conductors in colours chosen to match most common building materials.

Standard PVC colours are shown in the chart above, with special colours available to order.

Conductors for earthing systems

For below ground earthing applications we offer a large range of bare copper tape, solid circular and stranded conductors thus offering the designer of the system the correctly rated conductor without the need to oversize.

Conductor Size (mm)	C.S.A. (mm ²)	kA for 1 Sec	kA for 3 Sec
12.5 x 1.5	18.75	3.3	1.9
12.5 x 3	37.5	6.6	3.8
20 x 1.5	30	5.3	3.0
20 x 3	60	10.6	6.1
25 x 1.5	37.5	6.6	3.8
25 x 3	75	13.2	7.6
25 x 2	50	8.8	5.1
25 x 4	100	17.6	10.2
25 x 6	150	26.4	15.2
30 x 2	60	10.6	6.1
30 x 3	90	15.8	9.1
30 x 4	120	21.1	12.2
30 x 5	150	26.4	15.2
31 x 3	93	16.4	9.5
31.5 x 4	126	22.2	12.8
31 x 6	186	32.7	18.9
38 x 3	114	20.1	11.6
38 x 5	190	33.4	19.3
38 x 6	228	40.1	23.2
40 x 3	120	21.1	12.2
40 x 4	160	28.2	16.3
40 x 5	200	35.2	20.3
40 x 6	240	42.2	24.4
40 x 6.3	252	44.4	25.6
50 x 3	150	26.4	15.2
50 x 4	200	35.2	20.3
50 x 5	250	44.0	25.4
50 x 6	300	52.8	30.5
50 x 6.3	315	55.4	32.0
50 x 7	350	61.6	35.5
50 x 8	400	70.4	40.6
50 x 10	500	88	50.8
60 x 10	600	105.6	61
80 x 6	480	84.4	48.8
100 x 6	600	105.6	61

These conductor ratings are based upon the recommendations of BS 7430 with an initial conductor temperature of 30°C and a maximum temperature of 250°C

Furse earthing conductors form an integral part of the single earthing arrangement for a structure, whether they provide the means of connection to the final earth electrode (earth rod or plate), or whether they comprise the earth electrode itself (through an earth grid or ring earth arrangement).

An earth conductor must be capable of carrying the maximum expected earth fault current and leakage current likely to occur at a structure. The size or minimum cross-sectional area of the conductor must therefore be gauged in accordance with these criteria.

A good earth conductor must also:

- Be able to withstand mechanical damage
- Be compatible with the material of the earth electrode
- Resist the corrosive effect of local soil conditions

Furse conductors effectively meet these requirements and are available in a range of sizes to meet differing current ratings (see table left). Copper conductor is recommended as, following BS 7430, aluminium should not be installed in contact with soil, nor in damp areas, and it should not be used to make the final connection to an earth electrode.

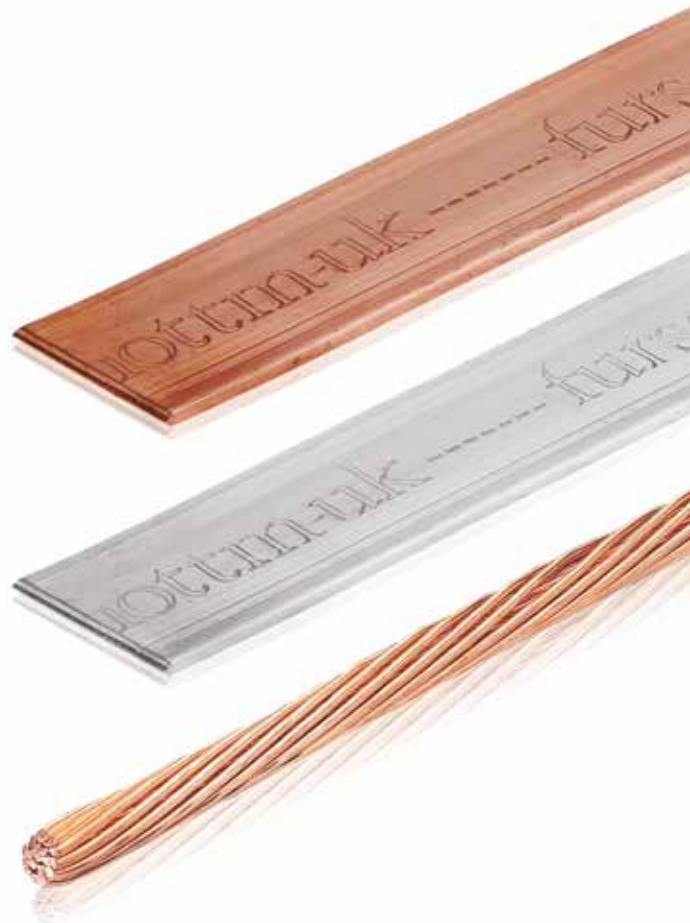

Conductors

Bare conductors

3



Standards

BS EN 13601
IEC/BS EN 62561-2

UL96 (TC030-UL, TC040-UL,
TC080)



Bare copper tape

Part no.	Conductor size (X x Y) (mm)	Standard coil size (m)	Weight per metre (kg)
TC005	12.5 x 1.5	100	0.17
TC010	12.5 x 3	100	0.33
TC015	20 x 1.5	100	0.27
TC020	20 x 3	50	0.53
TC020/100	20 x 3	100	0.53
TC025	25 x 1.5	100	0.33
TC026	25 x 2	50	0.49
TC030	25 x 3	25	0.67
TC030/50	25 x 3	50	0.67
TC030-UL	1" x 1/8"	25	0.67
TC035	25 x 4	50	0.89
TC040	25 x 6	40	1.33
TC040-UL	1" x 1/4"	40	1.33
TC039	30 x 2	50	0.53
TC042	30 x 3	50	0.80
TC044	30 x 4	40	1.07
TC043	30 x 5	40	1.33
TC045	31 x 3	50	0.83
TC048	31.5 x 4	40	1.13
TC050	31 x 6	30	1.65
TC055	38 x 3	50	1.01
TC060-FU	38 x 5	30	1.69
TC065	38 x 6	25	2.02
TC067	40 x 3	40	1.06
TC066	40 x 4	30	1.42
TC071	40 x 5	25	1.78
TC068	40 x 6	25	2.16
TC069	40 x 6.3	25	2.24
TC070	50 x 3	40	1.33
TC075	50 x 4	30	1.78
TC078	50 x 5	20	2.22
TC080	50 x 6	20	2.68
TC082	50 x 6.3	20	2.80
TC090	50 x 7	320	3.08
TC092	50 x 8	20	3.56
TC094	50 x 10	10	4.44
TC096	60 x 10	10	5.32
TC098	80 x 6	10	4.32
TC099	100 x 6	10	5.36

- All bare copper tape sold in full coil lengths only
- High conductivity annealed copper tape

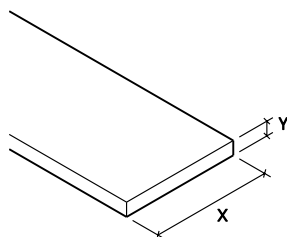

Conductors

Bare conductors



Bare aluminium tape

Part no.	Conductor size (X x Y) (mm)	Standard coil size (m)	Weight per metre (kg)
TA005	12.5 x 1.5	50	0.05
TA020	20 x 3	50	0.17
TA030	25 x 3	50	0.21
TA042	30 x 3	50	0.25
TA040	25 x 6	50	0.42
TA068	40 x 6	50	0.67
TA080	50 x 6	50	0.85

Standards

BS EN 755-5
IEC/BS EN 62561-2

– All bare aluminium tape sold in full coil lengths only

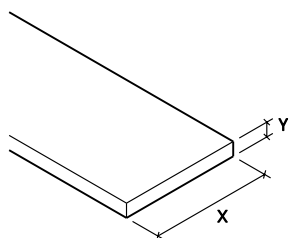

Bare solid circular

Part no.	Conductor material	Diameter (A) (mm)	Cross-sectional area (mm ²)	Standard coil size (m)	Weight per metre (kg)
Copper conductor					
CD035	Copper	Ø 8	50.27	50	0.44
Aluminium conductor					
CD080	Aluminium	Ø 8	50.27	50	0.12
Tinned copper conductor					
CD235	Copper	Ø 8	50.27	50	0.44

– All solid circular conductor sold in full coil lengths only

Standards

BS EN 13601 (copper)
BS EN 755-5 (aluminium)

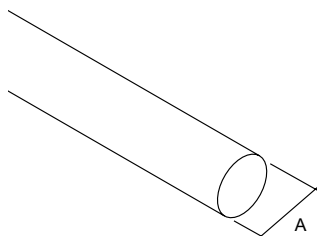

Conductors

Bare stranded & tinned conductors

3



Bare stranded copper cable

Part no.	Cross-sectional area (mm ²)	Stranding no. / mm ø	Nominal diameter (A) (mm)	Weight per metre (kg)
Soft drawn stranded copper cable				
CB006	6	7/1.04	Ø 3.12	0.05
CB016	16	7/1.70	Ø 5.10	0.15
CB025	25	7/2.14	Ø 6.42	0.23
CB035	35	7/2.52	Ø 7.56	0.32
CB050-FU	50	19/1.78	Ø 8.90	0.43
CB070	70	19/2.14	Ø 10.70	0.62
CB095	95	19/2.52	Ø 12.60	0.86
CB120	120	37/2.03	Ø 14.21	1.09
CB150-FU	150	37/2.25	Ø 15.75	1.33
CB185	185	37/2.52	Ø 17.64	1.67
CB240	240	61/2.25	Ø 20.25	2.20
CB300-FU	300	61/2.52	Ø 22.68	2.76
CB400-FU	400	61/2.85	Ø 25.65	3.53
Tinned soft drawn stranded copper cable				
CB070-T*	70	19/2.14	Ø 10.70	0.62
Hard drawn stranded copper cable				
CB071*	70	7/3.55	Ø 10.70	0.64

– *Additional sizes available on request

Standards

BS EN 60228 (soft drawn)
BS EN 7884 (hard drawn)

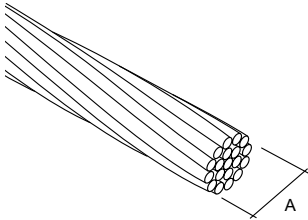

Tinned copper tape

Part no.	Conductor size (X x Y) (mm)	Standard coil size (m)	Weight per metre (kg)
TC220	20 x 3	50	0.53
TC225-FU	12.5 x 1.5	100	0.17
TC226	25 x 2	50	0.49
TC230	25 x 3	50	0.67
TC230-UL	1" x 1/8"	50	0.67
TC239	30 x 2	50	0.53
TC240	25 x 6	40	1.33
TC245	31 x 3	50	0.83
TC260	38 x 5	30	1.69
TC266	40 x 4	30	1.42
TC267	40 x 3	40	1.06
TC280	50 x 6	20	2.68

– All tinned copper tape sold in full coil lengths only
– High conductivity annealed tinned copper tape

Standards

BS EN 13601
IEC/BS EN 62561-2

UL96 (TC230-UL)

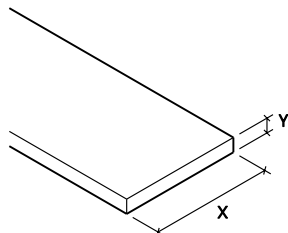

Conductors

Bimetallic cable & hard drawn bar



Bimetallic cable

Part no.	AWG	Cross-sectional area (mm ²)	Nominal diameter (mm)	Stranding no. / AWG	Weight per metre (kg)
BC001	1/0	50	Ø 9.96	3/5	0.41
BC002	1	40	Ø 8.86	3/6	0.33
BC003	2	35	Ø 7.90	3/7	0.26
BC004	3	25	Ø 7.04	3/8	0.21
BC005	4	20	Ø 6.27	3/9	0.16
BC006	5	16	Ø 5.59	3/10	0.13
BC007	6	10	Ø 4.42	3/12	0.08
BC008	300	150	Ø 15.6	7/4	1.22
BC009	4/0	120	Ø 13.9	7/5	0.97
BC010	3/0	95	Ø 12.3	7/6	0.77
BC011	2/0	70	Ø 11.00	7/7	0.61
BC012	1/0	50	Ø 9.78	7/8	0.48
BC013	1	40	Ø 8.71	7/9	0.38
BC014	2	35	Ø 7.77	7/10	0.30

Standards



– 40% conductivity supplied as standard. Other sizes also available. Contact us for details



Hard drawn copper bar

Part no.	Overall nominal size (X x Y) (mm)	Approximate length (m)	Weight per metre (kg)
Bare hard drawn bar			
BA205	25 x 3	3	0.67
BA210	25 x 6	4	1.33
BA225	38 x 6	4	2.03
BA230	50 x 6	3	2.67
BA235	50 x 10	4	4.45
BA240	75 x 6	4	4.00
BA250-FU	100 x 6	4	5.38
Tinned hard drawn bar			
BA206	25 x 3	3	0.67
BA211	25 x 6	4	1.33
BA226	38 x 6	4	2.03
BA231	50 x 6	3	2.67
BA236	50 x 10	4	4.45
BA241	75 x 6	4	4.00
BA251-FU	100 x 6	4	5.38

Standards

BS EN 12163

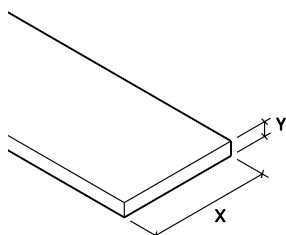

– Other sizes available on request

Conductors

Flexible braid



3

Standards

BS EN 13602

Flexible flat copper braid

Part no.	Overall nominal size (X x Y) (mm)	Cross-sectional area (mm ²)	Weight per metre (kg)
Bare flat braid			
BD020	12 x 1	6	0.06
BD025	15 x 1.5	10	0.10
BD026	19 x 2.5	16	0.16
BD028	25 x 3	25	0.25
BD030	25 x 3.5	35	0.34
BD031	30 x 5	50	0.49
BD027	32 x 6	70	0.63
BD032	37 x 6	95	0.93
BD033	45 x 6	120	1.15
BD034	50 x 8	150	1.45
Tinned flat braid			
BD020-T	12 x 1	6	0.06
BD025-T	15 x 1.5	10	0.10
BD026-T	19 x 2.5	16	0.16
BD028-T	25 x 3	25	0.25
BD035	25 x 3.5	35	0.34
BD031-T	30 x 5	50	0.49
BD027-T	32 x 6	70	0.63
BD032-T	37 x 6	95	0.93
BD033-T	45 x 6	120	1.15
BD034-T	50 x 8	150	1.45

- Suitable for earth bonding. Also supplied as standard pre-cut and drilled bonds
- Other sizes and types of braid can be made to order. Please contact us for details

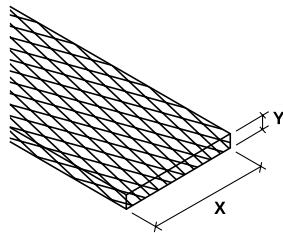

Conductors

Flexible braid

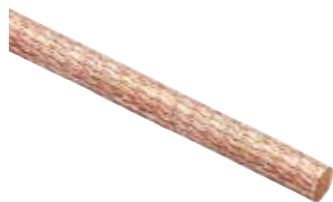

Standards

BS EN 13602

Flexible circular copper braid

Part no.	Overall nominal diameter (mm)	Cross-sectional area (mm ²)	Weight per metre (kg)
Bare circular braid			
BD006-FU	Ø 4.2	6	0.06
BD010-FU	Ø 5.4	10	0.10
BD016-FU	Ø 7	16	0.16
BD025-FU	Ø 8.5	25	0.25
BD035-FU	Ø 10.5	35	0.34
BD050-FU	Ø 11.5	50	0.49
BD070-FU	Ø 14.5	70	0.63
BD095-FU	Ø 16	95	0.93
Tinned circular braid			
BD006-FU-T	Ø 4.2	6	0.06
BD010-FU-T	Ø 5.4	10	0.10
BD016-FU-T	Ø 7	16	0.16
BD025-FU-T	Ø 8.5	25	0.25
BD035-FU-T	Ø 10.5	35	0.34
BD050-FU-T	Ø 11.5	50	0.49
BD070-FU-T	Ø 14.5	70	0.63
BD095-FU-T	Ø 16	95	0.93

- Suitable for earth bonding. Also supplied as standard pre-cut and drilled bonds
- Other sizes and types of braid can be made to order. Please contact us for details

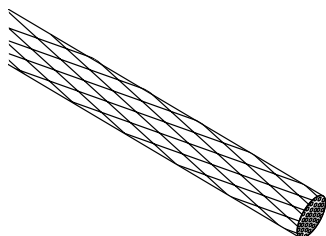

Conductors

PVC covered conductors

3



Standards

BS EN 13601 (copper)
BS 5252 (PVC colour,
*Green to BS 6746C)

PVC covered copper tape

Part no.	Conductor size (X x Y) (mm)	Standard coil size (m)	Weight per metre (kg)	Colour range
TC100	12.5 x 1.5	50	0.21	Black
TC105-FU	25 x 3	25	0.77	Black
TC105/50	25 x 3	50	0.77	Black
TC110	25 x 3	25	0.77	Green*
TC110/50	25 x 3	50	0.77	Green*
TC115-FU	25 x 3	25	0.77	Grey
TC115/50	25 x 3	50	0.77	Grey
TC120-FU	25 x 3	25	0.77	Stone
TC120/50	25 x 3	50	0.77	Stone
TC125-FU	25 x 3	25	0.77	White
TC125/50	25 x 3	50	0.77	White
TC130	25 x 3	25	0.77	Brown
TC130/50	25 x 3	50	0.77	Brown
TC140-FU	25 x 6	40	1.53	Green*
TC145	50 x 6	20	2.95	Green*

- Other colours and sizes are available to order
- Every precaution has been taken to ensure the UV stability of PVC coverings, but as with all plastics, colour variation will occur over time
- All PVC covered copper tape sold in full coil lengths only
- High conductivity annealed copper tape

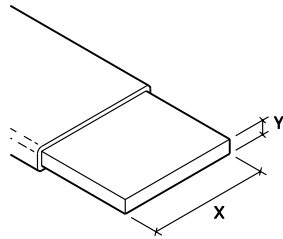

Standards

BS EN 13601 (copper)
BS 5252 (PVC colour,
*Green to BS 6746C)

PVC covered copper solid circular

Part no.	Conductor material	Diameter (A) (mm)	Cross-sectional area (mm ²)	Standard coil size (m)	Weight per metre (kg)	Colour range
CD036	Copper	Ø 8	50.27	50	0.49	Black
CD038	Copper	Ø 8	50.27	50	0.49	Grey
CD039	Copper	Ø 8	50.27	50	0.49	Stone
CD040	Copper	Ø 8	50.27	50	0.49	White
CD041	Copper	Ø 8	50.27	50	0.49	Brown

- Other colours and sizes are available to order
- Every precaution has been taken to ensure the UV stability of PVC coverings, but as with all plastics, colour variation will occur over time
- All PVC covered copper solid circular sold in full coil lengths only

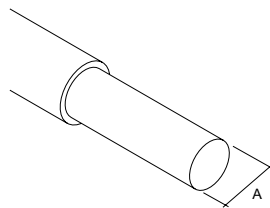

Conductors

PVC covered conductors



PVC covered aluminium tape

Part no.	Conductor size (X x Y) (mm)	Standard coil size (m)	Weight per metre (kg)	Colour range
TA100	12.5 x 1.5	50	0.09	Black
TA104	20 x 3	50	0.25	Black
TA105	25 x 3	50	0.30	Black
TA110	25 x 3	50	0.30	Green*
TA115	25 x 3	50	0.30	Grey
TA120	25 x 3	50	0.30	Stone
TA125	25 x 3	50	0.30	White
TA130	25 x 3	50	0.30	Brown
TA140	25 x 6	50	0.60	Green*

Standards

BS EN 755-5 (aluminium)
BS 5252 (PVC colour,
*Green to BS 6746C)

- Other colours and sizes are available to order
- Every precaution has been taken to ensure the UV stability of PVC coverings, but as with all plastics, colour variation will occur over time
- All PVC covered aluminium tape sold in full coil lengths only

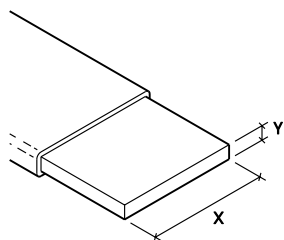

PVC covered aluminium solid circular

Part no.	Diameter (A) (mm)	Cross-sectional area (mm ²)	Standard coil size (m)	Weight per metre (kg)	Colour range
CD081	Ø 8	50.27	50	0.18	Black
CD083	Ø 8	50.27	50	0.18	Grey
CD084	Ø 8	50.27	50	0.18	Stone
CD085	Ø 8	50.27	50	0.18	White
CD086	Ø 8	50.27	50	0.18	Brown

Standards

BS EN 755-5 (aluminium)
BS 5252 (PVC colour)

- Other colours and sizes are available to order
- Every precaution has been taken to ensure the UV stability of PVC coverings, but as with all plastics, colour variation will occur over time
- All PVC covered aluminium solid circular sold in full coil lengths only

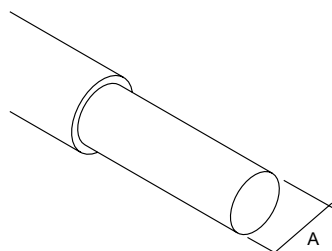

Conductors

PVC covered conductors

3



Green & yellow PVC insulated copper tape

Part no.	Conductor size (X x Y) (mm)	Standard coil size (m)	Weight per metre (kg)	Colour range
TC111-FU	25 x 3	25	0.79	Green & Yellow
TC111/50	25 x 3	50	0.79	Green & Yellow

- High conductivity annealed copper tape
- All PVC covered copper tape sold in full coil lengths only

Standards

BS EN 13601 (copper)
BS 6746C (PVC colour)

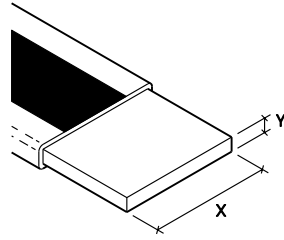

Green & yellow PVC insulated stranded copper cable

Part no.	Cross-sectional area (mm ²)	Stranding no. / mm ø	Weight per metre (kg)	Colour range
CC016	16	7/1.70	0.19	Green & Yellow
CC025	25	7/2.14	0.29	Green & Yellow
CC035	35	7/2.52	0.41	Green & Yellow
CC050	50	19/1.78	0.53	Green & Yellow
CC070	70	19/2.14	0.73	Green & Yellow
CC095	95	19/2.52	1.00	Green & Yellow
CC120-FU	120	37/2.03	1.27	Green & Yellow
CC150-FU	150	37/2.25	1.54	Green & Yellow
CC185	185	37/2.52	2.01	Green & Yellow
CC240	240	61/2.25	2.49	Green & Yellow
CC300	300	61/2.52	3.05	Green & Yellow
CC400-FU	400	61/2.85	3.90	Green & Yellow

Standards

BS EN 50525 (copper)
BS 6746C (PVC colour)

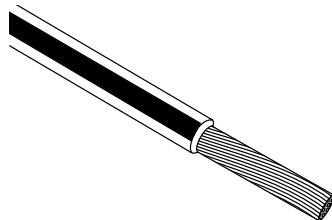





Conductors

LSOH & lead covered conductors



LSOH covered copper tape

Part no.	Conductor size (X x Y) (mm)	Standard coil size (m)	Weight per metre (kg)	Colour range
TC910	25 x 3	25	0.77	 Green
TC910/50	25 x 3	50	0.77	 Green
TC940	25 x 6	40	1.53	 Green
TC980	50 x 6	20	2.95	 Green

Standards

BS EN 13601 (copper)
BS 6746C (PVC colour)

- Other colours and sizes are available to order
- All LSOH covered copper tape sold in full coil lengths only

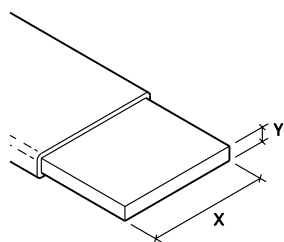

Lead covered copper tape

Part no.	Conductor size (X x Y) (mm)	Standard coil size (m)	Weight per metre (kg)
TC330	25 x 3	2.56	25

- All lead covered copper tape sold in full coil lengths only

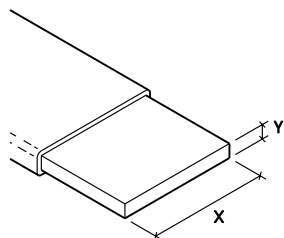

Standards

BS EN 13601

Conductors

Conductor guards

3



PVC protective down conductor guard

Part no.	Length (mm)	Weight each (kg)	Colour range
GC205	3000	1.00	Black
GC215	3000	1.00	Grey
GC220	3000	1.00	Stone
GC225	3000	1.00	White
GC230	3000	1.00	Brown

Standards

BS 1006 (PVC colour)

- Protects against vandalism and opportunity theft
- High impact PVC, UV stabilized to BS 1006 to reduce colour degradation
- Suitable to protect bare 25 x 3 mm flat tape, Ø 8 mm solid circular and 50 mm² stranded cable
- Fix using roundhead wood screws (Part no. SW405) and wall plugs (PS305)
- Other colours available to order

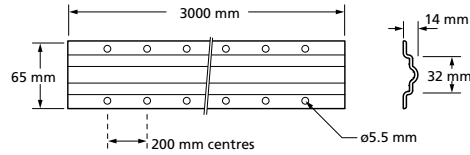

Anti-vandal down conductor guard

Part no.	Length (mm)	Weight each (kg)
AV005	3000	2.90

- Protects against vandalism and opportunity theft
- High impact PVC, UV stabilized to BS 1006 to reduce colour degradation
- Suitable to protect bare 25 x 3 mm flat tape, Ø 8 mm solid circular and 50 mm² stranded cable
- Fix using No. 10 x 1½" countersunk, roundhead or security screws and wall plugs

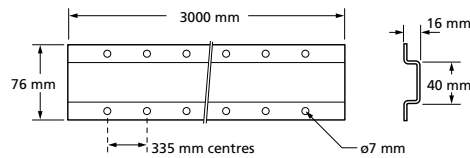



Air termination

Air termination

Introduction	4/2
--------------	-----

Air rods

Air rods	4/3
----------	-----

Air rod bases & saddles

Air rod base	4/4
Horizontal or vertical air rod base	4/4
Flat saddle	4/5
Ridge saddle	4/5

Air rod brackets & rod to conductor coupling

Rod brackets	4/6
Rod to conductor coupling	4/6

Multiple point

Multiple point	4/7
----------------	-----

Strike pad

Strike pad	4/7
------------	-----

Free-standing air termination

Introduction	4/8
Free-standing interception pole	4/10
Free-standing interception pole base frame	4/11
Free-standing interception pole concrete base	4/11

Air termination

Introduction

4



Air termination plays a critical role in the lightning protection system, capturing the fullness of the lightning strike current and channeling this current safely to the conductor network.

It is therefore highly important to install a correctly designed air termination system.

IEC/BS EN 62305-3 advocates the use of air rods or catenary conductors to provide a protective zone above the roof structure and any prominent parts, such as HVAC systems, plus a meshed conductor network to protect flat or slightly inclined roof areas.

Through use of air rods, raised conductor or mesh, a Lightning Protection System designer can achieve appropriate positioning of the air termination in line with the three methods proposed by IEC/BS EN 62305, namely:

- The rolling sphere method
- The protective angle method
- The mesh method

These methods are detailed within our technical reference section (p16/10).

Furse air termination products are specifically designed to provide highly effective protection against the risks and consequences from a direct lightning strike.

Our air rods are manufactured from high conductivity hard drawn copper or aluminium, and provide an excellent, durable strike point for lightning. Supplied with locknut and rolled threads, these air rods fix easily to our air rod bases.

Our comprehensive range of air rod bases, conductor fasteners and clamps is manufactured from high quality copper or aluminium alloys, to ensure that a high level of conductivity is maintained throughout the air termination system, and that these components are robust enough to last a significant number of years on exposed roof lines.

All these components link together with our copper or aluminium conductors, which provide the low resistance path for lightning current, from strike point safely to earth.

Air termination Air rods



Air rod base and multiple point not included.

Standards

BS EN 50164-2

UL96 (RA215, RA225)



Air rod

Part no.	Rod length (mm)	Rod diameter (mm)	Thread size	Conductor material	Weight each (kg)
RA215	500	Ø 15	M16	Copper	0.73
RA225	1000	Ø 15	M16	Copper	1.51
RA230	1500	Ø 15	M16	Copper	2.35
RA240	2000	Ø 15	M16	Copper	3.00
RA250-FU	3000	Ø 15	M16	Copper	4.70
RA015	500	Ø 15	M16	Aluminium	0.29
RA025	1000	Ø 15	M16	Aluminium	0.53
RA030	1500	Ø 15	M16	Aluminium	0.80
RA040	2000	Ø 15	M16	Aluminium	1.06
RA050	3000	Ø 15	M16	Aluminium	1.60
RA400-FU	500	Ø 10	M10	Copper	0.33
RA402	1000	Ø 10	M10	Copper	0.65
RA080	500	Ø 10	M10	Aluminium	0.11
RA085	1000	Ø 10	M10	Aluminium	0.22

– Manufactured from high conductivity hard drawn copper or aluminium, with rolled threads. Supplied complete with locknut

Note: during high winds and extreme weather conditions air rods over 1000 mm long can be subjected to fatigue mechanisms. It is therefore recommended that additional supports are considered before installation

“Field Trials in the United States, carried out over many years of research have confirmed that blunt air rods are struck by lightning in preference to taper pointed air rods.”

Lightning rod improvement studies

by C B Moore, W Rison, J Mathis, G Aulich,

Journal of Applied Meteorology, May 2000.

Air termination Air rod bases & saddles



Air rod base

Part no.	Air rod diameter (mm)	Thread size	Maximum conductor width (mm)	Conductor material	Weight each (kg)
SD105-H	Ø 15	M16	25	Copper	0.43
SD003-H	Ø 15	M16	25	Aluminium	0.14
SD120	Ø 15	M16	50	Copper	0.7

- Manufactured from high quality alloys of either copper or aluminium
- Simple to install, providing an effective connection between air rod and air termination tape
- Fix using countersunk wood screws (Part no. SW005 or SW105) and wall plugs (Part no. PS305)
- SD120 not as illustrated (drawing available on request)

4

Standards

IEC/BS EN 62561-1 Class H

UL96 (SD105-H)

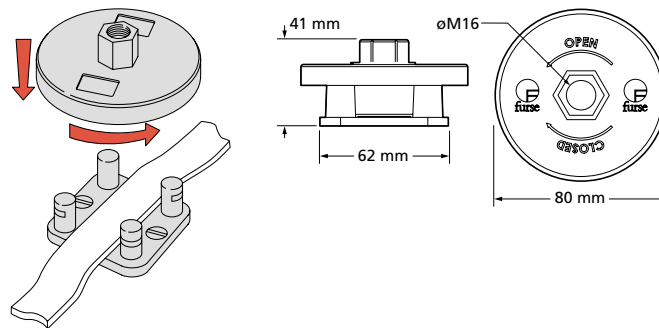

SD307



Horizontal or vertical air rod base

Part no.	Air rod diameter (mm)	Thread size	Conductor size (mm)	Conductor material	Mounting plane	Weight each (kg)
SD305	Ø 10	M10	Ø 8	Copper	Horizontal	0.30
SD307	Ø 10	M10	Ø 8	Copper	Vertical	0.30
SD005	Ø 10	M10	Ø 8	Aluminium	Horizontal	0.11
SD007	Ø 10	M10	Ø 8	Aluminium	Vertical	0.11

- Manufactured from high quality alloys of either copper or aluminium
- Simple to install, providing an effective connection between air rod and solid circular air termination conductor, in either the horizontal or vertical plane
- Fix using countersunk wood screws 1½" No. 10 or M6 (Part no. SW005 or SW105) and wall plugs (Part no. PS305)
- Tightening torque 15 Nm

SD305

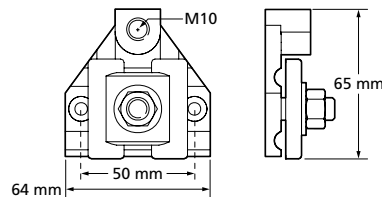

Standards

BS EN 62561-1 Class H

Air termination

Air rod bases & saddles



Flat saddle

Part no.	Air rod diameter (mm)	Thread size	Conductor size (mm ²)	Conductor material	Weight each (kg)
SD155	Ø 15	M16	50	Copper	1.03
SD160	Ø 15	M16	70	Copper	0.95
SD165	Ø 15	M16	95	Copper	0.95

- Manufactured from high quality copper alloy
- Simple to install, providing an effective connection between air rod and stranded conductor
- Fix using countersunk wood screws 1½" No. 10 or M6 (Part no. SW005) and wall plugs (Part no. PS305)
- Tightening torque 12 Nm

Standards

IEC/BS EN 62561-1 Class H

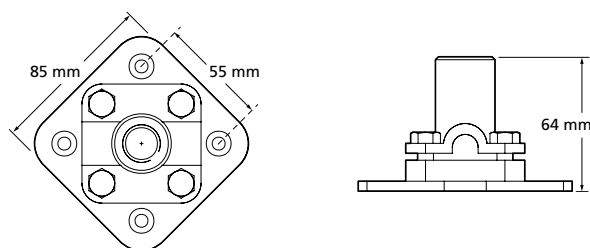

Ridge saddle

Part no.	Air rod diameter (mm)	Thread size	Max. conductor width (mm)	Conductor material	Weight each (kg)
SD015	Ø 15	M16	31	Aluminium	0.45
SD115	Ø 15	M16	31	Copper	1.07

- Manufactured from high quality alloys of either copper or aluminium
- Simple to install, providing an effective fixing for lightning conductor air rods on ridges
- Fix using countersunk wood screws 1½" No. 10 or M6 (Part no. SW005 or SW105) and wall plugs (Part no. PS305)
- Tightening torque 15 Nm

Standards

BS EN 62561-1 Class H

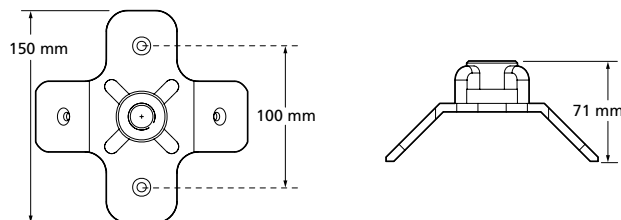

Air termination

Air rod brackets & rod to conductor coupling

4



Rod brackets

Part no.	Air rod diameter (mm)	Air rod material	Weight each (kg)
BR105	Ø 15	Copper	0.90
BR005	Ø 15	Aluminium	0.28

- Manufactured from high quality alloys of either copper or aluminium
- Simple to install, providing an effective means of mounting an air rod on to a vertical surface e.g. chimney stack
- Use in conjunction with a rod to tape or rod to stranded conductor coupling
- Fix using roundhead wood screws 1½" x No. 12 or M8 and wall plugs

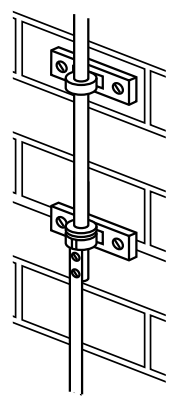

Rod to conductor coupling

Part no.	Air rod diameter (mm)	Thread size	Conductor size (mm)	Air rod material	Weight each (kg)
For use with flat tape conductor					
CG600	Ø 15	M16	25 x 3	Copper	0.23
CG500	Ø 15	M16	25 x 3	Aluminium	0.08
For use with stranded conductor					
CG705	Ø 15	M16	50-70 mm ²	Copper	0.25
CG710	Ø 15	M16	95 mm ²	Copper	0.25

- Manufactured from high quality alloys of either copper or aluminium
- Provides an effective connection between air rod and air termination tape or stranded air termination conductor
- Tightening torque 7 Nm (tape); 6 Nm (stranded)

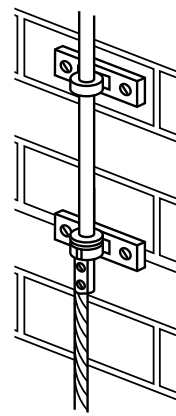

Standards

BS EN 62561-1 Class H

Air termination

Multiple point & strike pad



RA600



RA500

Multiple point

Part no.	Air rod diameter (mm)	Air rod material	Weight each (kg)
RA600	Ø 15	Copper	0.27
RA500	Ø 15	Aluminium	0.10

- Manufactured from high conductivity hard drawn copper or aluminium
- Suitable for use with 15 mm diameter air rods (see page 4/3)



Strike pad

Part no.	Conductor material	Weight each (kg)
PL010	Copper	0.41
PL005	Aluminium	0.13

Accessories

SM005	Stainless steel stem for use with PL005	0.06
SM010	Copper stem for use with PL010	0.07

- Strike pads manufactured from high quality alloys of either copper or aluminium
- Provides an exposed attractive point on conductor systems hidden/embedded in the building's fabric, e.g. below the tiles of a pitched roof
- Supplied with setscrew for attachment of lightning conductors

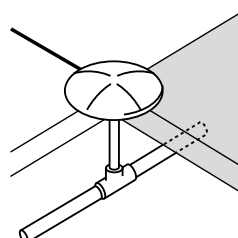
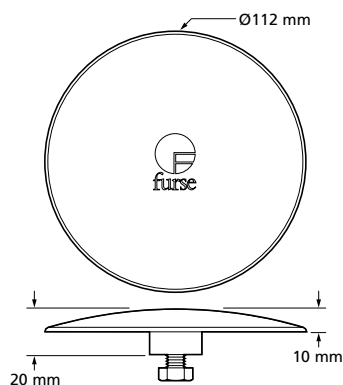

Air termination

Free-standing air termination

Furse free-standing interception air rods are designed to protect rooftop mounted or exposed equipment, such as air conditioning units or photovoltaic panels, from a direct lightning strike.

Free-standing interception air rods are easily constructed from a small range of components including air rod or interception pole, support frame and concrete base, to create a complete unit which when connected to the air termination network provides a highly versatile and effective lightning protection solution.

Features & benefits

- Protects rooftop mounted equipment from direct lightning strikes
- Complies with IEC/BS EN 62305 standard
- Lightweight construction
- Corrosion resistant
- Quick and easy to assemble
- Available in a range of heights from 0.5 m to 10 m
- Range of frames and concrete weights for different wind zones
- Large protection zones
- Modular, versatile and robust

Note: installed interception air rods must have sufficient height to provide a clear zone of protection around the equipment to be protected, as defined by IEC/BS EN 62305-3 (see page 16/11). Further information can be found in the Furse Guide to BS EN 62305.

Interception air rod (0.5 m to 2 m height)

- Copper or aluminium air rod
- Circular concrete base
- Rod connects directly into base

Interception air rod (3 m to 4 m height)

- 2 piece interception pole with square support frame
- 4 square concrete bases (or 8 doublestacked for higher wind speeds)

Interception air rod (4.5 m to 5.5 m height)

- 2 piece interception pole with tripod support frame
- 3 circular concrete bases

Interception air rod (6 m to 8 m height)

- 3 piece interception pole with tripod support frame
- 6 circular concrete bases

Interception air rod (8 m to 10 m height)

- 3 piece interception pole with 'H' shaped support frame
- 10 circular concrete bases

All items sold as separates to form a complete free-standing air rod when combined at installation (see product selection guide on following page).

- 1 Interception air rod - 0.5 m to 2 m height | 2 Interception air rod - 3 m to 4 m height
3 Interception air rod - 4.5 m to 5.5 m height | 4 Interception air rod - 6 m to 8 m height | 5 Interception air rod - 8 m to 10 m height



Product selection

Free-standing air rod selection is based on two factors:

- Air rod height required to create the necessary protective zone around the equipment
- Anticipated wind loading at the installation

Wind loading is an important factor, especially for taller interception air rods as extreme weather can subject them to fatigue mechanisms.

For UK installations, the map featured right highlights four key wind zones from which the appropriate free-standing air rod can be established.

Relevant part numbers can then be determined through cross referencing wind loading with the height of air rod required in the table below.

For non-UK installations, please refer to available data for local wind conditions or contact your Furse representative to discuss your particular requirements.

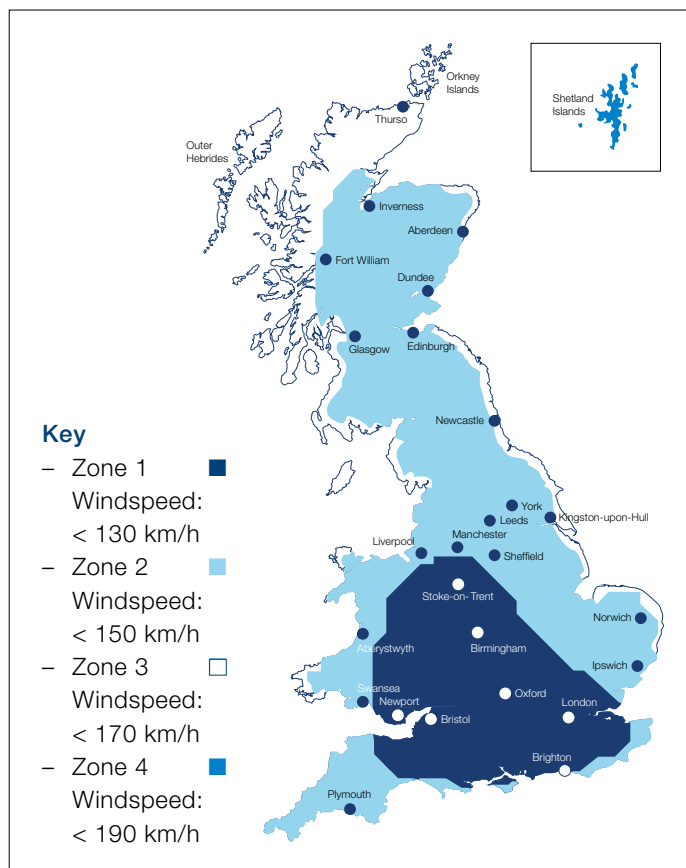

UK wind zone map

Product selection guide - Free-standing air termination

Rod height (m)	Interception pole Part no.	Frame (where required) and base part no. for windspeeds			
		< 130 km/h	< 150 km/h	< 170 km/h	< 190 km/h
0.5	RA215 or RA015	103101-FU	103101-FU	103101-FU	103101-FU
1	RA225 or RA025	103101-FU	103101-FU	103101-FU	103101-FU
1.5	RA230 or RA030	103110-FU	103110-FU	103110-FU	103110-FU
2	RA240 or RA040	103110-FU	103110-FU	103110-FU	103110-FU
3	912000-FU	499000-FU / 4 x 499100-FU	499000-FU / 4 x 499100-FU	499000-FU / 4 x 499100-FU	499000-FU / 4 x 499100-FU
3.5	912001-FU	499000-FU / 4 x 499100-FU	499000-FU / 4 x 499100-FU	499000-FU / 4 x 499101-FU	499000-FU / 4 x 499101-FU
4	912002-FU	499000-FU / 4 x 499100-FU	499000-FU / 4 x 499101-FU	499000-FU / 8 x 499100-FU	499000-FU / 8 x 499101-FU
4.5	912003-FU	499005-FU / 3 x 103101-FU	499005-FU / 3 x 103110-FU	499005-FU / 3 x 103118-FU	499006-FU / 3 x 103103-FU
5	912004-FU	499005-FU / 3 x 103101-FU	499005-FU / 3 x 103110-FU	499005-FU / 3 x 103118-FU	499006-FU / 3 x 103103-FU
5.5	912005-FU	499005-FU / 3 x 103110-FU	499005-FU / 3 x 103118-FU	499006-FU / 6 x 103103-FU	499006-FU / 3 x 103103-FU
6	912006-FU	499006-FU / 6 x 103103-FU	499006-FU / 6 x 103103-FU	499006-FU / 6 x 103103-FU	499006-FU / 6 x 103101-FU
6.5	912007-FU	499006-FU / 6 x 103103-FU	499006-FU / 6 x 103103-FU	499006-FU / 6 x 103101-FU	499006-FU / 6 x 103118-FU
7	912008-FU	499006-FU / 6 x 103103-FU	499006-FU / 6 x 103101-FU	499006-FU / 6 x 103110-FU	On request
7.5	912009-FU	499006-FU / 6 x 103101-FU	499006-FU / 6 x 103110-FU	499006-FU / 6 x 103118-FU	On request
8	912010-FU	499006-FU / 6 x 103110-FU	499006-FU / 6 x 103118-FU	499007-FU / 10 x 103118-FU	On request
9	912011-FU	499007-FU / 10 x 103118-FU	499007-FU / 10 x 103118-FU	499007-FU / 10 x 103118-FU	On request
10	912013-FU	499007-FU / 10 x 103118-FU	499007-FU / 10 x 103118-FU	On request	On request

Air termination

Free-standing air termination

4



Free-standing interception pole

Part no.	Pole height (m)	Pole diameter (mm)	Pole construction	Weight each (kg)
912000-FU	3	Ø 10-42	2 piece	5.0
912001-FU	3.5	Ø 10-42	2 piece	5.5
912002-FU	4	Ø 10-42	2 piece	7.0
912003-FU	4.5	Ø 10-42	2 piece	9.2
912004-FU	5	Ø 10-42	2 piece	10.0
912005-FU	5.5	Ø 10-42	2 piece	10.6
912006-FU	6	Ø 10-60	3 piece	18.0
912007-FU	6.5	Ø 10-60	3 piece	19.0
912008-FU	7	Ø 10-60	3 piece	23.5
912009-FU	7.5	Ø 10-60	3 piece	26.0
912010-FU	8	Ø 10-60	3 piece	28.7
912011-FU	9	Ø 10-60	3 piece	30.5
912013-FU	10	Ø 10-60	3 piece	35.5

- Interception poles manufactured from stainless steel 304 with aluminium interception tip
- For construction of interception air rods from 3 to 10 m in height comprising interception pole, support frame and concrete bases
- Multi-component, stackable system with screw retention. Supplied with 3 terminal lugs for base frame connection

Air termination

Free-standing air termination



499000-FU



499005-FU

Interception pole position shown for illustration purposes. Pole not included.

Free-standing interception pole base frame

Part no.	Frame type	Frame dimension (mm)	Weight each (kg)
499000-FU	Square base	650 x 650	7
499005-FU	Tripod base	1350 x 1350	8
499006-FU	Tripod base	1850 x 1850	24.5
499007-FU	H shaped base	1850 x 1850	39.5

- Manufactured from 304 grade stainless steel
- Dimensions are approximate and include holding down bases.



103103-FU

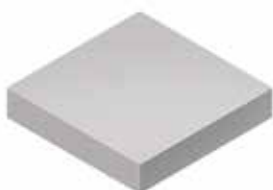

499100-FU

Free-standing interception pole base

Part no.	Description	Weight each (kg)
499100-FU	Square concrete base 300 x 300 x 60 mm	12
499101-FU	Square concrete base 300 x 300 x 80 mm	16
103103-FU	Circular concrete base with M16 insert	12
103101-FU	Circular concrete base with M16 insert	16
103110-FU	Circular concrete base with M16 insert	20
103118-FU	Circular concrete base with M16 insert	25

Accessories

103102-FU	Protective polyethylene tray for circular concrete blocks	0.4
919828-FU	Stainless steel clamp for connecting 25 x 3 mm copper tape to 5-19 mm thickness steel	0.55



Conductor network

Metallic conductor clips

Swing lid DC tape clip	5/2
Adjustable DC tape clip	5/2
DC tape clip	5/3
Tape clip	5/3
One hole cable clip	5/4
Heavy duty cast cable saddle	5/4

Non-metallic conductor clips

Non-metallic DC tape clip	5/5
Non-metallic push-in clip	5/5

Glue down conductor clips

Glue down DC tape clip	5/6
Glue down push-in clip	5/6

Self adhesive non-metallic conductor clips

Self adhesive DC tape clip	5/7
Self adhesive push-in clip	5/7

Solvent weldable non-metallic conductor clips

Solvent weldable DC tape clip	5/8
Solvent weldable push-in clip	5/8

Heat weldable non-metallic conductor clips

Heat weldable DC tape clip	5/9
Heat weldable push-in clip	5/9
Heat weldable DC tape clip for T.P.O. roofing	5/10
Heat weldable DC tape clip for F.P.O. roofing	5/10

Non-metallic conductor clip accessories

Universal welding solvent	5/11
Cleaning solution (Acetone)	5/11
Surface primer	5/11
Dressing tool	5/11

Felt roofing conductor clips

Bitumen felt roof clip	5/11
------------------------	------

Standing seam roof fixings

Standing seam roof fixing with non-metallic DC tape clip	5/12
Standing seam roof fixing with square tape clamp	5/12

Slate holdfasts

Slate holdfast with non-metallic DC tape clip	5/13
Slate holdfast with non-metallic push-in clip	5/13

Holdfasts

Glazing bar holdfast	5/14
Back plate holdfast stem	5/14
Pyramid holdfast	5/15

Puddle flange

Puddle flange	5/15
---------------	------

Conductor clamps

Square clamp	5/16
Crossover clamp	5/16
Cable to tape square clamp	5/17
Cable to cable square clamp	5/17
Mini square clamp	5/18
Tee clamp	5/18
Jointing clamp	5/19
Test / Junction clamp	5/19
Plate type test clamp	5/20
Screwdown test clamp	5/20
Test clamp	5/21
Square test clamp	5/21

Bimetallic connectors

Bimetallic connector	5/22
----------------------	------

Oxide inhibitor

Oxide inhibiting compound	5/23
---------------------------	------

Expansion braid bond

Expansion braid bond	5/23
----------------------	------

Accessories

Countersunk wood screws	5/24
Countersunk set screws	5/24
Roundhead wood screws	5/24
Hexagon head set screws	5/24
Plastic wall plugs	5/25
Hexagon nuts	5/25
Roundhead rivets	5/25
Spring washers	5/25
Masonry drills	5/26
Roundhead copper nails	5/26
Plain washers	5/26
Insulating tape	5/26
Denso tape	5/27
Tinmans solder	5/27
Silfos	5/27
Flux	5/27

Conductor network

Metallic conductor clips



Swing lid DC tape clip

Part no.	Conductor size (mm)	Weight each (kg)
For use with bare copper		
CP210-H	25 x 3	0.07
CP220-H	25 x 6	0.08
For use with bare aluminium		
CP110-H	25 x 3	0.03
CP120-H	25 x 6	0.04
For use with PVC covered copper		
CP215-H	25 x 3	0.08

Standards

IEC/BS EN 62561-4 (CP210-H, CP110-H)

5 UL96 (CP2610-H, CP-220H)



- DC tape clips manufactured from high quality alloys of either copper or aluminium for excellent corrosion resistance and high pull off loads
- Fix using countersunk wood screws 1½" No. 10 or M6 (Part no. SW005 or SW105) and wall plugs (Part no. PS305)

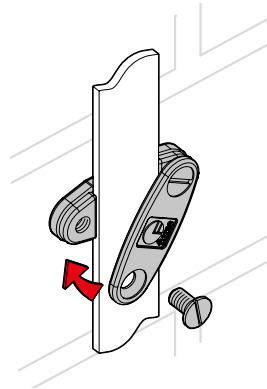

Adjustable DC tape clip

Part no.	Conductor size (mm)	Weight each (kg)
For use with bare copper		
CP230-H	31 x 3 and 31 x 6	0.12
CP240-H	38 x 3, 38 x 6 and 40 x 6	0.14
CP260-H	50 x 3 and 50 x 6	0.16

- DC tape clips manufactured from high quality copper alloy for excellent corrosion resistance and high pull off loads
- Variable thicknesses of conductor are accommodated by a reversible lid
- Fix using countersunk wood screws 1½" No. 10 or M6 (Part no. SW005 or SW105) and wall plugs (Part no. PS305)

Standards

IEC/BS EN 62561-4

UL96 (CP260-H)

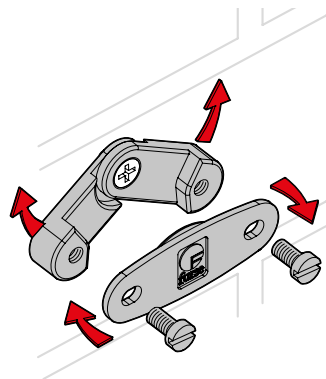

Conductor network

Metallic conductor clips

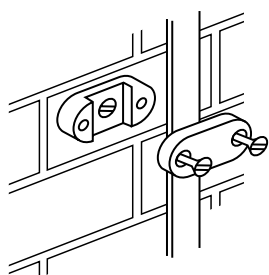

Standards

IEC/BS EN 62561-4 (CP115)

DC tape clip

Part no.	Conductor size (mm)	Weight each (kg)
For use with bare copper		
CP205	20 x 3	0.06
CP216	25 x 4	0.07
CP227	30 x 5	0.10
CP245	38 x 5	0.12
CP241	40 x 4	0.14
CP256	50 x 4	0.15
For use with PVC covered copper		
CP225	25 x 6	0.13
CP265	50 x 6	0.26
For use with lead covered copper		
CP305	25 x 3	0.20
For use with bare aluminium		
CP105	20 x 3	0.02
CP125	50 x 6	0.05
For use with PVC covered aluminium		
CP115	25 x 3	0.04
CP130	50 x 6	0.06

- High quality alloys of either copper or aluminium down conductor clip for securing flat tape
- Other sizes available to order
- Fix using countersunk wood screws 1½" No. 10 or M6 (Part no. SW005 or SW105) and wall plugs (Part no. PS305)

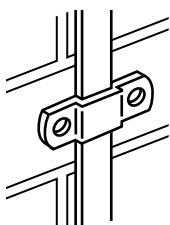

Tape clip

Part no.	Conductor size (mm)	Weight each (kg)
For use with bare copper		
CP510	20 x 3	0.02
CP515	25 x 3	0.02
For use with bare aluminium		
CP405	20 x 3	0.01
CP410	25 x 3	0.01
CP415	25 x 6	0.01
For use with PVC covered tape		
CP517	25 x 3	0.02

- Manufactured from pure copper or aluminium, these pressed clips are available in a range of sizes to suit bare and PVC covered copper and aluminium tapes
- Fix using roundhead wood screws 1½" No. 10 or M6 (Part no. SW305 or SW405) and wall plugs (Part no. PS305)

Conductor network

Metallic conductor clips



One hole cable clip

Part no.	Conductor size (mm)	Conductor material	Weight each (kg)
For use with solid circular conductor			
CP905	Ø 8	Copper	0.01
CP925	Ø 8	Aluminium	0.01
CP915	Ø 10*	Copper	0.01
CP935	Ø 10*	Aluminium	0.01
For use with stranded conductor			
CP910	50 mm ²	Copper	0.01
CP915	70 mm ²	Copper	0.01
CP920	95 mm ²	Copper	0.01

- Manufactured from pure copper or aluminium, these pressed clips are available to suit bare and PVC covered copper and aluminium solid circular conductor, and bare copper stranded conductor
- Fix using roundhead wood screws 1½" No. 10 or M6 (Part no. SW305 or SW405) and wall plugs (Part no. PS305)
- *PVC covered Ø8 mm conductor
- Clip supplied in open position

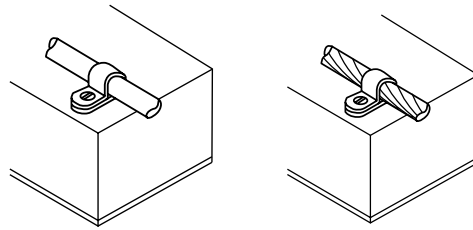

Heavy duty cast cable saddle

Part no.	Conductor size (mm)	Conductor material	Weight each (kg)
For use with solid circular conductor			
CP805	Ø 8	Copper	0.09
CP806	Ø 8	Aluminium	0.03
CP815	Ø 10*	Copper	0.10
CP816	Ø 10*	Aluminium	0.04
For use with stranded conductor			
CP810	50 mm ²	Copper	0.10
CP815	70 mm ²	Copper	0.10
CP835	95 mm ²	Copper	0.10
CP855	120 mm ²	Copper	0.10

- Manufactured from high quality alloys of either copper or aluminium for excellent corrosion resistance and high pull off loads
- Fix using countersunk wood screws 1½" No. 10 or M6 (Part no. SW005 or SW105) and wall plugs (Part no. PS305)
- *For use with PVC covered Ø8 mm conductor or for supporting air terminals when used in conjunction with wall mounted air rod bases.
- Can also be used with glazing bar holdfast and back plate holdfast stem

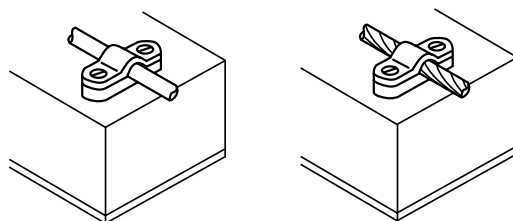

Standards

IEC/BS EN 62561-4

Conductor network

Non-metallic conductor clips



Standards

IEC/BS EN 62561-4

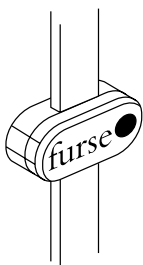

Non-metallic DC tape clip

Part no.	Conductor size (mm)	Colour	Weight each (kg)
For use with bare tape			
CP005	20 x 3	Brown	0.01
CP010	20 x 3	Grey	0.01
CP015	25 x 3	Brown	0.01
CP020	25 x 3	Grey	0.01
CP060*	38 x 5	Brown	0.01
CP065*	50 x 6	Brown	0.02
For use with PVC covered tape			
CP025	25 x 3	Brown	0.01
CP030	25 x 3	Black	0.01
CP035	25 x 3	Green	0.01
CP040	25 x 3	Grey	0.01
CP045	25 x 3	Stone	0.01
CP050	25 x 3	White	0.01

- High grade Polypropylene, UV stabilized against degradation by sunlight and non-brittle to prevent cold weather damage
- Available in six colours to match bare and PVC covered copper and aluminium tapes
- Fix using countersunk wood screws 1½" No. 10 or M6 (Part no. SW005 or SW105) and wall plugs (Part no. PS305)
- *Not as illustrated (drawing available on request)

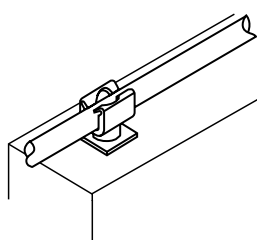

Non-metallic push-in clip

Part no.	Conductor size (mm)	Colour	Weight each (kg)
For use with bare solid circular conductor			
CP887	Ø 8	Brown	0.01
CP872	Ø 8	Grey	0.01
For use with PVC covered solid circular conductor			
CP886	Ø 10*	Brown	0.01
CP861	Ø 10*	Black	0.01
CP871	Ø 10*	Grey	0.01
CP876	Ø 10*	Stone	0.01
CP881	Ø 10*	White	0.01

- High grade Polypropylene, UV stabilized against degradation by sunlight and non-brittle to prevent cold weather damage
- Available in five colours to match bare and PVC covered copper and aluminium solid circular conductors
- Fix using countersunk wood screws 1½" No. 10 or M6 (Part no. SW005 or SW105) and wall plugs (Part no. PS305)
- *PVC covered Ø8 mm conductor

Conductor network

Glue down non-metallic conductor clips



Standards

IEC/BS EN 62561-4

5

Glue down DC tape clip

Part no.	Conductor size (mm)	Colour	Weight each (kg)
For use with bare tape			
GD015	25 x 3	Brown	0.03
GD020	25 x 3	Grey	0.03
For use with PVC covered tape			
GD025	25 x 3	Brown	0.03
GD030	25 x 3	Black	0.03
GD040	25 x 3	Grey	0.03
GD045	25 x 3	Stone	0.03
GD050	25 x 3	White	0.03

- Use on clay roof tiles. Supplied in a box of 50 complete with adhesive. Additional glue gun is required
- Disc Ø 85 mm
- Dressing tool accessory (DT100) enables flat tape to be set at roof level

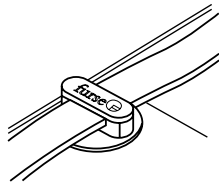

Glue down push-in clip

Part no.	Conductor size (mm)	Colour	Weight each (kg)
For use with bare solid circular conductor			
GD887	Ø 8	Brown	0.03
GD872	Ø 8	Grey	0.03
For use with PVC covered solid circular conductor			
GD886	Ø 10*	Brown	0.03
GD861	Ø 10*	Black	0.03
GD871	Ø 10*	Grey	0.03
GD876	Ø 10*	Stone	0.03
GD881	Ø 10*	White	0.03

- Use on clay roof tiles. Supplied in a box of 50 complete with adhesive. Additional glue gun is required
- Disc Ø 85 mm
- *PVC covered Ø 8 mm conductor

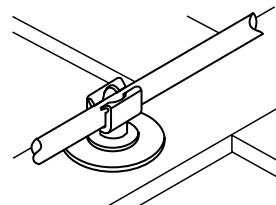

Conductor network

Self adhesive non-metallic conductor clips



Standards

IEC/BS EN 62561-4

Self adhesive DC tape clip

Part no.	Conductor size (mm)	Colour	Weight each (kg)
For use with bare tape			
CA015-FU	25 x 3	Brown	0.03
CA020-FU	25 x 3	Grey	0.03
For use with PVC covered tape			
CA025-FU	25 x 3	Brown	0.03
CA030-FU	25 x 3	Black	0.03
CA040-FU	25 x 3	Grey	0.03
CA045-FU	25 x 3	Stone	0.03
CA050-FU	25 x 3	White	0.03

- Designed to secure conductors to surfaces that cannot be penetrated by a screw. Ideal for aluminium, spangled galvanized steel, colour coated steel, glass, perspex, enamel and stainless steel etc.
- Manufactured from high grade synthetic polymers, UV stabilized against degradation by sunlight and non-brittle to prevent cold weather damage. Use on surfaces other than PVC roofing
- Disc Ø 64 mm
- Dressing tool accessory (DT100) enables flat tape to be set at roof level.

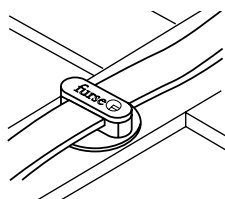

Self adhesive push-in clip

Part no.	Conductor size (mm)	Colour	Weight each (kg)
For use with bare solid circular conductor			
CA887	Ø 8	Brown	0.02
CA872	Ø 8	Grey	0.02
For use with PVC covered solid circular conductor			
CA886	Ø 10*	Brown	0.02
CA861	Ø 10*	Black	0.02
CA871	Ø 10*	Grey	0.02
CA876	Ø 10*	Stone	0.02
CA881	Ø 10*	White	0.02

- Designed as a means of securing conductors to surfaces that cannot be penetrated by a screw. Ideal for aluminium, spangled galvanized steel, colour coated steel, glass, perspex, enamel and stainless steel.
- Manufactured from high grade synthetic polymers, UV stabilized against degradation by sunlight and non-brittle to prevent cold weather damage. Use on surfaces other than PVC roofing
- Disc Ø 64 mm
- *PVC covered Ø 8 mm conductor

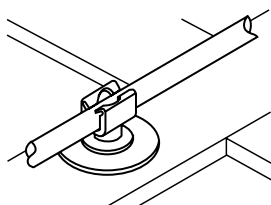

Conductor network

Solvent weldable non-metallic conductor clips



Standards

IEC/BS EN 62561-4

5

Solvent weldable DC tape clip

Part no.	Conductor size (mm)	Colour	Weight each (kg)
For use with bare tape			
CW015-FU	25 x 3	Brown	0.03
CW020-FU	25 x 3	Grey	0.03
For use with PVC covered tape			
CW025-FU	25 x 3	Brown	0.03
CW030-FU	25 x 3	Black	0.03
CW040-FU	25 x 3	Grey	0.03
CW045-FU	25 x 3	Stone	0.03
CW050-FU	25 x 3	White	0.03

- Provides a secure means of fixing conductors to single ply PVC roof membranes
- Manufactured from high grade synthetic polymers, UV stabilized against degradation by sunlight and non-brittle to prevent cold weather damage
- Use with welding solvent CW905. Dressing tool accessory (DT100) enables flat tape to be set at roof level
- Disc Ø 64 mm

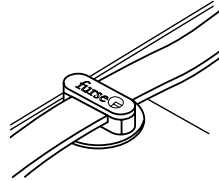

Solvent weldable push-in clip

Part no.	Conductor size (mm)	Colour	Weight each (kg)
For use with bare solid circular conductor			
CW887	Ø 8	Brown	0.03
CW872	Ø 8	Grey	0.03
For use with PVC covered solid circular conductor			
CW886	Ø 10*	Brown	0.03
CW871	Ø 10*	Grey	0.03

- Provides a secure means of fixing conductors to single ply PVC roof membranes
- Manufactured from high grade synthetic polymers, UV stabilized against degradation by sunlight and non-brittle to prevent cold weather damage
- Disc Ø 64 mm
- *PVC covered Ø8 mm conductor

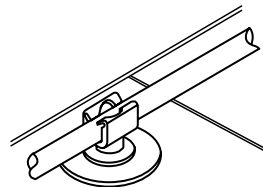

Conductor network

Heat weldable non-metallic conductor clips



Heat weldable clips for PVC roofing

Part no.	Conductor size (mm)	Colour	Weight each (kg)
For use with bare tape			
HW015-FU	25 x 3	Brown	0.03
HW020-FU	25 x 3	Grey	0.03
For use with PVC covered tape			
HW025-FU	25 x 3	Brown	0.03
HW030-FU	25 x 3	Black	0.03
HW040-FU	25 x 3	Grey	0.03
HW045-FU	25 x 3	Stone	0.03
HW050-FU	25 x 3	White	0.03
For use with bare solid circular conductor			
HW887	Ø 8	Brown	0.03
HW872	Ø 8	Grey	0.03
For use with PVC covered solid circular conductor			
HW886	Ø 10*	Brown	0.03
HW871	Ø 10*	Grey	0.03

Standards

IEC/BS EN 62561-4

- Provides a secure means of fixing flat tape conductors to single ply, PVC roof membranes using an industrial heat gun, where solvent welding is not applicable
- Manufactured from high grade synthetic polymers, UV stabilized against degradation by sunlight and non-brittle to prevent cold weather damage
- Dressing tool accessory (DT100) enables flat tape to be set at roof level
- Disc Ø 85 mm
- *PVC covered Ø 8 mm conductor

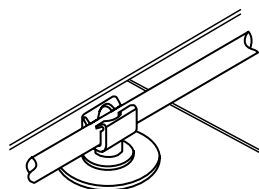
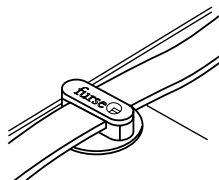

Conductor network

Heat weldable non-metallic conductor clips



Heat weldable clips for TPO/FPO roofing

Part no.	Conductor size (mm)	Colour	Weight each (kg)
For use with bare tape			
HW315-FU	25 x 3	Brown	0.03
HW320-FU	25 x 3	Grey	0.03
For use with PVC covered tape			
HW325-FU	25 x 3	Brown	0.03
HW330-FU	25 x 3	Black	0.03
HW340-FU	25 x 3	Grey	0.03
HW345-FU	25 x 3	Stone	0.03
HW350-FU	25 x 3	White	0.03

- Provides a secure means of fixing flat tape conductors to single ply polypropylene roof membranes using an industrial heat gun, where solvent welding is not applicable
- Manufactured from high grade PVC, UV stabilized against degradation by sunlight and non-brittle to prevent cold weather damage
- Dressing tool accessory (DT100) enables flat tape to be set at roof level
- Disc Ø 85 mm

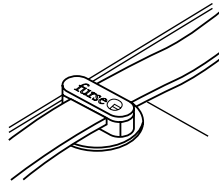

Standards

IEC/BS EN 62561-4

5



Heat weldable clips for polyethylene roofing

Part no.	Conductor size (mm)	Colour	Weight each (kg)
For use with bare tape			
HW415-FU	25 x 3	Brown	0.03
HW420-FU	25 x 3	Grey	0.03
For use with PVC covered tape			
HW425-FU	25 x 3	Brown	0.03
HW430-FU	25 x 3	Black	0.03
HW440-FU	25 x 3	Grey	0.03
HW445-FU	25 x 3	Stone	0.03
HW450-FU	25 x 3	White	0.03

- Provides a secure means of fixing flat tape conductors to single ply, polyethylene roof membranes using an industrial heat gun, where solvent welding is not applicable
- Manufactured from high grade synthetic polymers, UV stabilized against degradation by sunlight and non-brittle to prevent cold weather damage
- Dressing tool accessory (DT100) enables flat tape to be set at roof level
- Disc Ø 85 mm

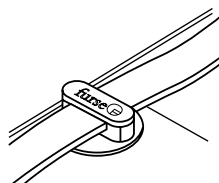

Standards

IEC/BS EN 62561-4

Conductor network

Non-metallic clip accessories & felt roof clip



Non-metallic clip accessories

Part no.	Description	Weight each (kg)
CW905	Universal welding solvent - 500 ml spray applicator (sufficient for application of approx 200 clips) Use with Furse solvent weldable clips only	0.57
CW999	Cleaning solution (Acetone) - 500 ml spray applicator For cleaning lacquered roofing membranes	0.62
CA900	Surface primer - 250 ml spray applicator (sufficient for application of approx 500 clips) Use with Furse adhesive clips only	0.24
DT100	Dressing tool - For use with adhesive and weldable DC tape clips	0.31

– Solvent and surface primer cannot be supplied outside the UK. For overseas projects, please contact us for advice
– CoSHH Datasheets available on request

5



Bitumen felt roof clip

Part no.	Conductor size (mm)	Clip colour	Weight each (kg)
For use with bare tape			
FP015	25 x 3	Brown	0.09
FP020	25 x 3	Grey	0.09
For use with PVC covered tape			
FP025	25 x 3	Brown	0.09
FP030	25 x 3	Black	0.09
FP035	25 x 3	Green	0.09
FP040	25 x 3	Grey	0.09
FP045	25 x 3	Stone	0.09
FP050	25 x 3	White	0.09

– Use on bitumen felt roofing only

Standards

IEC/BS EN 62561-4

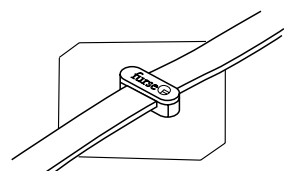

Conductor network

Standing seam roof fixings



Standing seam roof fixing with DC tape clip

Part no.	Conductor size (mm)	Colour	Conductor material	Weight each (kg)
Non-metallic clip for use with bare tape				
SC015	25 x 3	Brown	Copper	0.076
SC020	25 x 3	Grey	Aluminium	0.076
Metallic clip for use with bare tape				
SC210-H	25 x 3	–	Copper	0.08
SC110-H	25 x 3	–	Aluminium	0.07
Non-metallic clip for use with PVC covered tape				
SC025	25 x 3	Brown	Copper/Aluminium	0.076
SC030	25 x 3	Black	Copper/Aluminium	0.076
SC035	25 x 3	Green	Copper/Aluminium	0.076
SC040	25 x 3	Grey	Copper/Aluminium	0.076
SC045	25 x 3	Stone	Copper/Aluminium	0.076
SC050	25 x 3	White	Copper/Aluminium	0.076
Metallic clip for use with PVC covered tape				
SC215-H	25 x 3	–	Copper	0.09

- Highly versatile, innovative standing seam roof fixing including DC tape clip, suitable for use on multi-profiled seam roofing structures up to 22 mm thickness. Use with bare and PVC covered copper and aluminium conductors. Separate datasheet available on request
- Metallic clips not illustrated. Drawing available on request

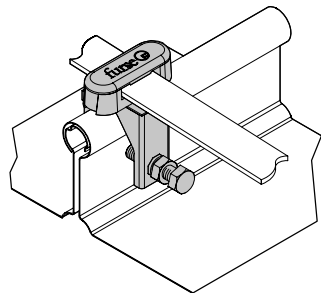

Standing seam roof fixing with square tape clamp

Part no.	Conductor size (mm)	Conductor material	Weight each (kg)
SC105-H	25 x 3	Copper	0.18
SC005-H	25 x 3	Aluminium	0.12

- Highly versatile, innovative standing seam roof fixing including square tape clamp, suitable for use on multi-profiled seam roofing structures up to 22 mm thickness. Use with bare and PVC covered copper and aluminium conductors. Separate datasheet available on request.

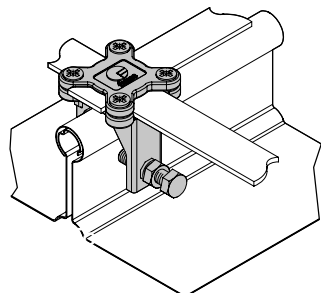

Conductor network

Slate holdfasts



Standards

IEC/BS EN 62561-4

Slate holdfast with non-metallic DC tape clip

Part no.	Conductor size (mm)	Clip colour	Weight each (kg)
For use with bare tape			
HF015	25 x 3	Brown	0.06
HF020	25 x 3	Grey	0.06
For use with PVC covered tape			
HF025	25 x 3	Brown	0.06
HF030	25 x 3	Black	0.06
HF040	25 x 3	Grey	0.06
HF045	25 x 3	Stone	0.06

– Designed to allow tape conductors to be fixed to tiled roofs without compromising the waterproofing nature of the roof. The 500 mm tail fits neatly between overlapping tiles and is wrapped around/fixed to the tile lathe for secure fitting

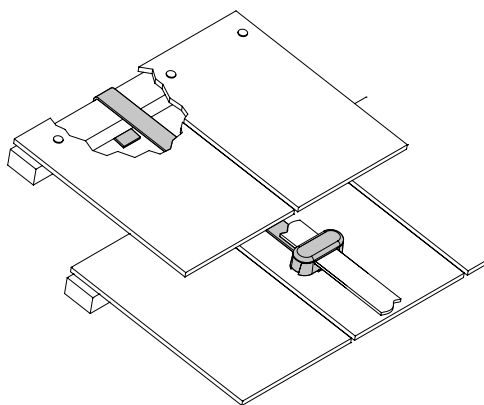

Slate holdfast with non-metallic push-in clip

Part no.	Conductor size (mm)	Clip colour	Weight each (kg)
HF176	Ø 8	Brown	0.03
HF191	Ø 8	Grey	0.03

– Designed to allow circular conductors to be fixed to tiled roofs without compromising the waterproofing nature of the roof. The 500 mm tail fits neatly between overlapping tiles and is wrapped around/fixed to the tile lathe for secure fitting

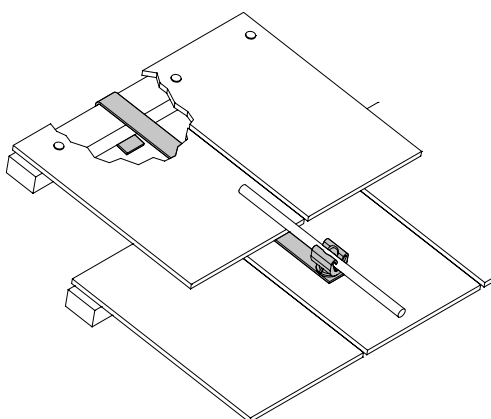

Conductor network

Holdfasts

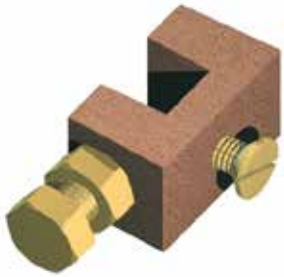

Glazing bar holdfast

Part no.	Conductor material	Maximum glazing bar width (mm)	Weight each (kg)
HF705	Copper	12	0.11
HF710	Aluminium	12	0.05

- Manufactured from high quality alloys of either copper or aluminium. Simple to install, providing secure anchorage to thin metallic sections that cannot be drilled e.g. window mullions, angle iron etc. Once fixed any metallic or non-metallic conductor clip can be attached with the screw provided
- Conductor clip sold separately

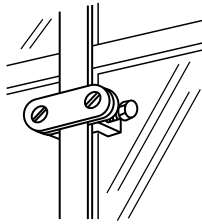

5



Back plate holdfast stem

Part no.	Conductor material	Weight each (kg)
HF320	Copper	0.30
HF325-FU	Aluminium	0.10

- Supplied with M6 fixing screw to secure appropriate conductor clip
- Fix using roundhead wood screws 1½" No. 10 or M6 (Part no. SW305 or SW405) and wall plugs (Part no. PS305)

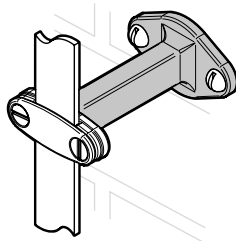

Conductor network

Holdfast & puddle flange



Pyramid holdfast

Part no.	Conductor size (mm)	Weight each (kg)
HF975	Ø 8 mm solid circular	0.97

- Designed to secure bare, 8 mm diameter, circular conductors to flat roofs
- Supplied filled with concrete the conductor is held in place by the weight of the holdfast
- The lip around the base of the product permits the holdfast to be built into bitumen type roofs

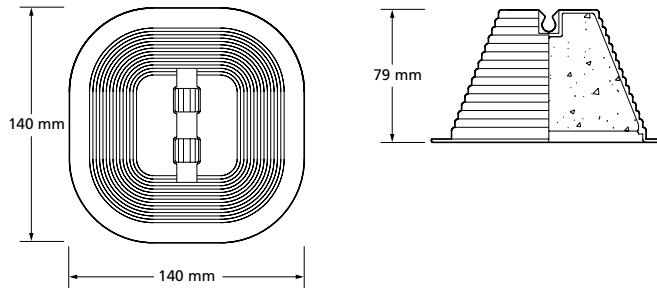

Puddle flange

Part no.	Conductor material	Weight each (kg)
PF105	Copper	1.54
PF005	Aluminium	0.50

- Permits lightning conductors to pass through flat roofs without damaging the waterproof nature of the roof

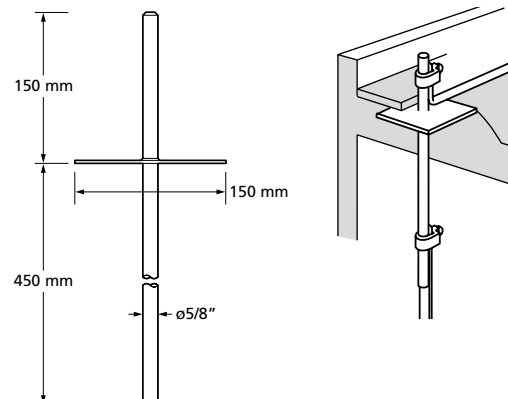

Conductor network

Conductor clamps



Square tape clamp

Part no.	Conductor size (mm)	Conductor material	Weight each (kg)
CT105-H	25 x 3	Copper	0.12
CT110-H	25 x 6	Copper	0.30
CT115-H	50 x 6	Copper	0.60
CT005-H	25 x 3	Aluminium	0.06
CT010-H	25 x 6	Aluminium	0.17

- Manufactured from high quality alloys of either copper or aluminium. Simple to install, providing an effective low resistance connection between overlapping tapes to allow cross, tee, through and right angle joints to be formed
- Fix using countersunk wood screws 1½" No. 10 or M6 (Part no. SW005 or SW105) and wall plugs (Part no. PS305)
- Tightening torque 5 Nm

5

Standards

IEC/BS EN 62561-1 Class H

UL96 (CT105-H, CT110-H, CT115-H)

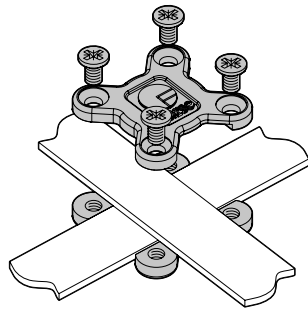

Crossover tape clamp

Part no.	Conductor size (mm)	Conductor material	Weight each (kg)
CX105-H	25 x 3	Copper	0.09
CX005-H	25 x 3	Aluminium	0.03

- Manufactured from high quality alloys of either copper or aluminium. Simple to install, providing an effective low resistance connection between overlapping tapes to allow cross joints to be formed
- Fix using countersunk wood screws 1½" No. 10 or M6 (Part no. SW005 or SW105) and wall plugs (Part no. PS305)
- Tightening torque 5 Nm

Standards

IEC/BS EN 62561-1 Class H

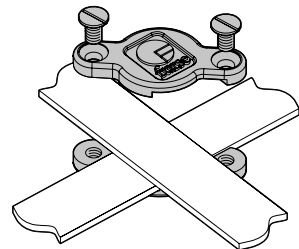

Conductor network

Conductor clamps



Cable to tape square clamp

Part no.	Conductor size	Conductor material	Weight each (kg)
CT125	25 x 3 mm to 50 mm ²	Copper	0.32
CT130	25 x 3 mm to 70 mm ²	Copper	0.30
CT135	25 x 3 mm to 95 mm ²	Copper	0.28

- Manufactured from high quality copper alloy. Simple to install, providing an effective low resistance connection between conductor tape and stranded copper conductor, allowing cross, tee, through and right angle joints to be formed
- Fix using countersunk wood screws 1½" No. 10 or M6 (Part no. SW005 or SW105) and wall plugs (Part no. PS305)
- Tightening torque 5 Nm

Standards

IEC/BS EN 62561-1 Class H

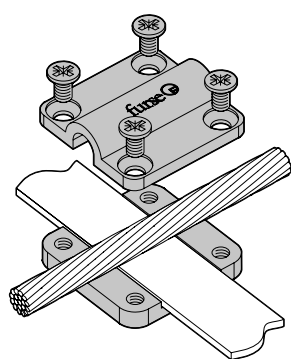

Cable to cable square clamp

Part no.	Conductor size (mm ²)	Conductor material	Weight each (kg)
CR810	50	Copper	0.32
CR815	70	Copper	0.29
CR820	95	Copper	0.25

- Manufactured from high quality copper alloy. Simple to install, providing an effective low resistance connection between overlapping stranded conductors allowing cross, tee, through and right angle joints to be formed
- Tightening torque 5 Nm

Standards

BS EN 62561-1 Class H

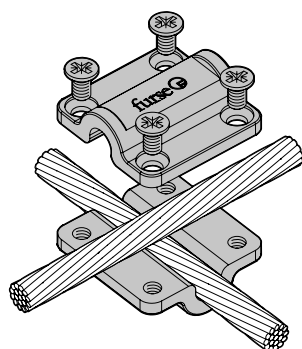

Conductor network

Conductor clamps



Mini square clamp

Part no.	Conductor size (mm)	Conductor material	Weight each (kg)
CS605	Ø 8	Copper	0.17
CS610	Ø 8	Aluminium	0.07

- Designed to provide low resistance cross joints in solid circular conductor networks. Manufactured from high quality alloys of either copper or aluminium for excellent corrosion resistance
- Tightening torque 12 Nm

Standards

BS EN 62561-1 Class H

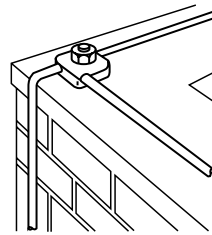

5



Tee clamp

Part no.	Conductor size (mm)	Conductor material	Weight each (kg)
CS505	Ø 8	Copper	0.17
CS510	Ø 8	Aluminium	0.07

- Designed to provide low resistance tee joints in solid circular conductor networks. Manufactured from high quality alloys of either copper or aluminium for excellent corrosion resistance
- Tightening torque 12 Nm

Standards

BS EN 62561-1 Class H

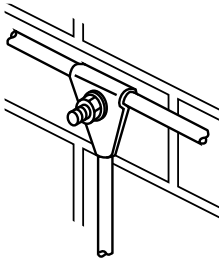

Conductor network

Conductor clamps



Joining clamp

Part no.	Conductor size (mm)	Conductor material	Weight each (kg)
CS405	Ø 8	Copper	0.17
CS410	Ø 8	Aluminium	0.08

- Designed to provide low resistance parallel joints in solid circular conductor networks. Manufactured from high quality alloys of either copper or aluminium for excellent corrosion resistance
- Tightening torque 12 Nm

Standards

BS EN 62561-1 Class H

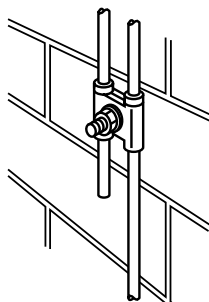

5



Test / Junction clamp

Part no.	Conductor size (mm)	Conductor material	Weight each (kg)
CN105-H	26 x 8	Copper	0.29
CN005*	26 x 8	Aluminium	0.12

- Manufactured from high quality alloys of either copper or aluminium. Simple to install, providing an effective low resistance connection between overlapping tapes. The clamped connection is easily made/remade to allow for periodic testing
- Tightening torque CN005 15 Nm; CN105-H 13 Nm
- * Not as illustrated (drawing available on request)

Standards

IEC/BS EN 62561-1 Class H

UL96 (CN105-H)

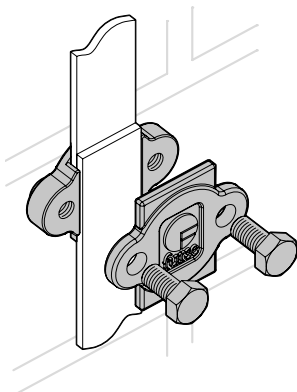

Conductor network

Conductor clamps



Plate type test clamp

Part no.	Conductor size (mm)	Conductor material	Weight each (kg)
CT405	26 x 12 max	Copper	0.62

- Manufactured from a high quality copper alloy. Simple to install, providing an effective low resistance connection between overlapping tapes.
- The clamped connection is easily made/remade to allow for periodic testing. Enables cross, tee, through and right angle joints to be formed
- Fix using countersunk wood screws 1½" No. 10 or M6 (Part no. SW005) and wall plugs (Part no. PS305)
- Tightening torque 15 Nm

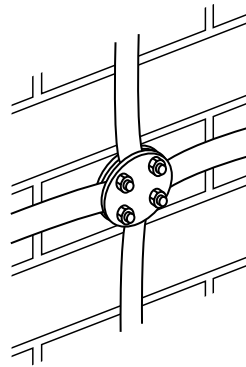

5

Standards

BS EN 62561-1 Class H



Screwdown test clamp

Part no.	Conductor size (mm)	Conductor material	Weight each (kg)
CT305	26 x 8 max	Copper	0.84

- Manufactured from a high quality copper alloy. Simple to install, providing an effective low resistance connection between overlapping tapes.
- The clamped connection is easily made/remade to allow for periodic testing. Enables cross, tee, through and right angle joints to be formed
- Fix using countersunk wood screws 1½" No. 10 or M6 (Part no. SW005) and wall plugs (Part no. PS305)
- Tightening torque 20 Nm

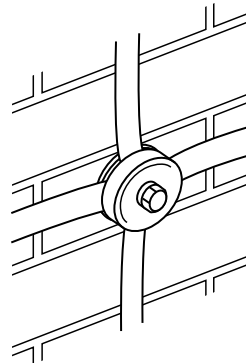

Standards

BS EN 62561-1 Class H

Conductor network

Conductor clamps



Test clamp

Part no.	Conductor size (mm)	Conductor size (mm)	Conductor material	Weight each (kg)
CN305	Ø 8	25 x 3	Copper	0.20
CN310	Ø 8	25 x 3	Aluminium	0.09

- Designed to provide low resistance tee joints in solid circular conductor networks. These multi-purpose clamps can produce circular to circular or circular to tape connection in both through and tee configurations
- Manufactured from high quality alloys of either copper or aluminium for excellent corrosion resistance
- Tightening torque 12 Nm

Standards

BS EN 62561-1 Class H

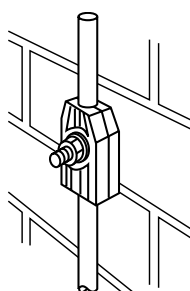

5



Square test clamp

Part no.	Conductor diameter (mm ²)	Conductor material	Weight each (kg)
CR855	50	Copper	0.39
CR860	70	Copper	0.40
CR865	95	Copper	0.40

- Manufactured from high quality copper alloy
- Simple to install, providing an effective low resistance overlap connection between stranded copper cables
- Fix using countersunk wood screws 1½" No. 10 or M6 (Part no. SW005) and wall plugs (Part no. PS305)
- Tightening torque 12 Nm

Standards

BS EN 62561-1 Class H

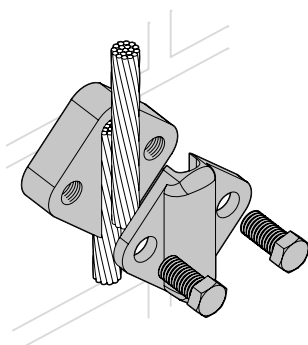

Conductor network

Bimetallic connectors



CN910



CN915



CN925

Bimetallic connector

Part no.	Conductor size	Weight each (kg)
CN910	25 x 3 mm aluminium tape to 25 x 3 mm copper tape	0.19
CN910-UL	1½" x ¼" aluminium tape to 1" x ¼" copper tape	0.19
CN915	8 mm Ø aluminium conductor to 8 mm Ø copper conductor	0.25
CN920	8 mm Ø aluminium conductor to 25 x 3 mm copper tape	0.19
CN925	25 x 3 mm aluminium tape to 25 x 3 mm copper tape	0.20

- Manufactured from a friction welded joint between high conductivity copper and aluminium to provide the ideal means of interconnecting copper and aluminium conductors whilst avoiding bimetallic corrosion
- Fix using countersunk wood screws 1½" No. 10 or M6 (Part no. SW005 or SW105) and wall plugs (Part no. PS305)
- Tightening torque 12 Nm

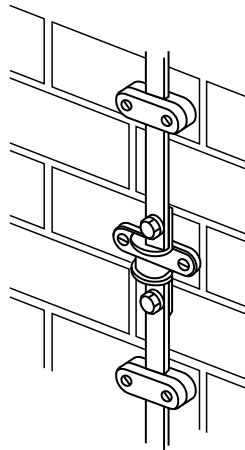

5

Standards

IEC/BS EN 62561-1 Class H

UL96 (CN910-UL)



Conductor network

Expansion braid bond & oxide inhibitor



Expansion braid bond

Part no.	Type	Conductor material	Length (mm)	Cross-sectional area (mm ²)	Weight each (kg)
BN101	Single length	Copper	200	50	0.17
BN001	Single length	Aluminium	200	50	0.07
BN102	Cross-over	Copper	300	50	0.53
BN002	Cross-over	Aluminium	300	50	0.23

– Designed to remove the risk of damage or distortion to long conductor runs caused by thermal expansion and contraction



Oxide inhibiting compound

Part no.	Description	Weight each (kg)
CM005	Plastic 8 oz bottle	0.23

– When installing mechanical and compression connectors, use oxide inhibiting compound to reduce risk of corrosion

Conductor network Accessories



Countersunk wood screws

Part no.	Material	Size	Weight per 100 (kg)
SW105	Zinc plated steel	1½" x No.10	0.50
SW110	Zinc plated steel	1½" x No.12	0.60
SW005	Brass	1½" x No.10	0.50
SW010	Brass	1½" x No.12	0.60



Countersunk set screws

Part no.	Material	Size (mm)	Weight Per 100 (kg)
SS160	Stainless Steel 316	M6 x 30	0.60
SS260	Stainless Steel 316	M6 x 30	0.61

5



Roundhead wood screws

Part no.	Material	Size	Weight per 100 (kg)
SW405	Zinc plated steel	1½" x No.10	0.50
SW305	Brass	1½" x No.10	0.50



Hexagon head set screws

Part no.	Material	Size (mm)	Weight per 100 (kg)
SS635	Phosphor bronze	M10 x 25	2.85
SS640	Phosphor bronze	M10 x 35	3.40
SS650	Phosphor bronze	M12 x 25	4.50
SS655	Phosphor bronze	M12 x 35	5.00
SS165	Brass	M8 x 16	1.75
SS140	Brass	M10 x 25	2.50
SS145	Brass	M10 x 35	3.20
SS150	Brass	M12 x 25	3.80
SS155	Brass	M12 x 35	4.70
SS235	Stainless Steel 316	M8 x 20	1.23
SS240	Stainless Steel 316	M10 x 25	2.57
SS245	Stainless Steel 316	M10 x 35	3.07
SS250	Stainless Steel 316	M12 x 25	3.66
SS255	Stainless Steel 316	M12 x 35	4.38

Conductor network

Accessories



Plastic wall plugs

Part no.	Colour	Size	Weight per 100 (kg)
PS305	Red	No.10	0.06
PS310	Brown	No.12	0.06



Hexagon nuts

Part no.	Material	Size	Weight per 100 (kg)
NU367	Phosphor bronze	M10	1.25
NU370	Phosphor bronze	M12	1.80
NU165	Brass	M6	0.25
NU166	Brass	M8	0.80
NU167	Brass	M10	1.15
NU170	Brass	M12	1.65
NU265	Stainless Steel 316	M6	0.25
NU266	Stainless Steel 316	M8	0.52
NU267	Stainless Steel 316	M10	1.16
NU270	Stainless Steel 316	M12	1.73

5



Roundhead rivets

Part no.	Material	Size (mm)	Weight per 100 (kg)
RV105	Copper	5 x 12	0.35
RV110	Copper	5 x 20	0.45
RV005	Aluminium	5 x 12	0.12
RV010	Aluminium	5 x 20	0.15



Spring washers

Part no.	Material	Size (mm)	Weight per 100 (kg)
WS365	Phosphor bronze	6	0.04
WS367	Phosphor bronze	10	0.20
WS370	Phosphor bronze	12	0.20
WS265	Stainless steel 316	6	0.04
WS266	Stainless steel 316	8	0.10
WS267	Stainless steel 316	10	0.20
WS270	Stainless steel 316	12	0.23

Conductor network

Accessories



Masonry drills

Part no.	Size	Weight each (kg)
DL005	No.10	0.02
DL010	No.12	0.02



Roundhead copper nails

Part no.	Length (mm)	Weight per 100 (kg)
NA005	50	0.70

5



Plain washers

Part no.	Material	Size (mm)	Weight per 100 (kg)
WR365	Phosphor bronze	6	0.05
WR367	Phosphor bronze	10	0.25
WR370	Phosphor bronze	12	0.50
WR165	Brass	6	0.05
WR175	Brass	8	0.15
WR167	Brass	10	0.25
WR170	Brass	12	0.50
WR265	Stainless Steel 316	6	0.06
WR266	Stainless Steel 316	8	0.11
WR267	Stainless Steel 316	10	0.21
WR270	Stainless Steel 316	12	0.34



Insulating tape

Part no.	Size	Weight each (kg)
TP120-FU	25 mm x 33 m	0.14

– Green/yellow general purpose insulating tape

Conductor network Accessories



Denso tape

Part no.	Size	Weight each (kg)
TD005	50 mm x 10 m	0.76

- A waterproof tape for wrapping underground joints
- COSHH datasheet available on request



Tinmans solder

Part no.	Material	Weight each (kg)
SA105	60% tin, 40% lead	0.26

- Use with tinmans solder for general purpose soldering of copper products
- CoSHH datasheet available on request



Silfos

Part no.	Coil size	Thickness (mm)	Weight each (kg)
FS005	50 mm x 8 m	0.12	0.50

- An alloy of silver, phosphorous and copper. Used to braze copper in air without the use of Flux
- CoSHH datasheet available on request



Flux

Part no.	Material	Weight each (kg)
SA115	Flux	0.08

- Use with tinmans solder for general purpose soldering of copper products
- CoSHH datasheet available on request

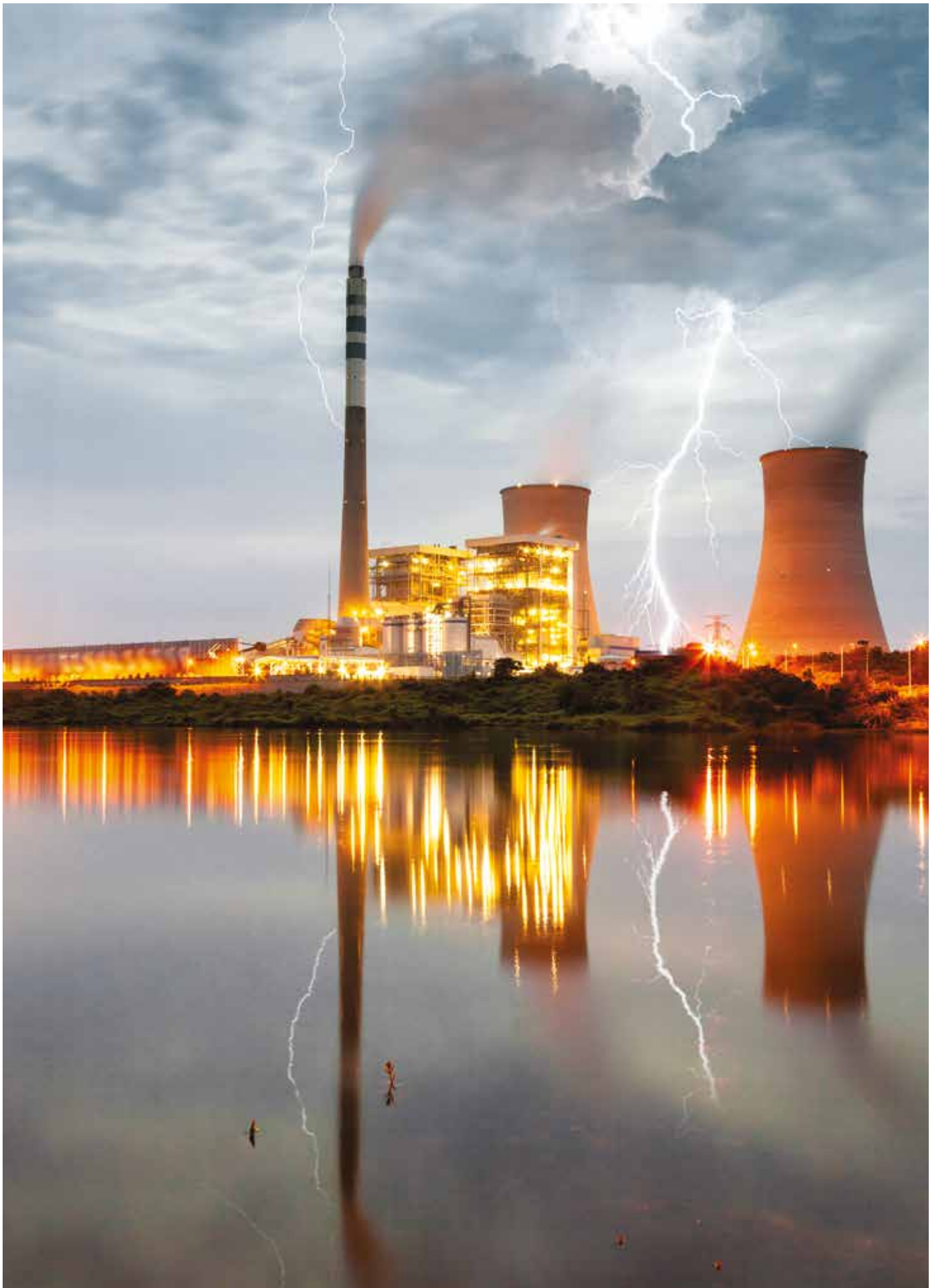

Earthing

Earthing

Introduction	6/2
Product selection guide	6/4

Earthing Introduction



6

Furse earthing components are manufactured to meet exacting British, European and International standards to ensure robust, long lasting performance in even the harshest soil conditions.

All components are designed to withstand mechanical damage and the thermal and electromechanical stresses from the earth fault and leakage currents expected within an installation.

These components, combined together, form the earth termination system - the vital system for dispersing those dangerous lightning and fault currents safely and effectively into the ground.

Following National & International standards, we recommend a single integrated earth termination system for a structure, combining lightning protection earthing with power and telecommunication system earthing.

This integrated approach ensures all systems are appropriately cross-bonded and earthed, to fully safeguard against the risk of voltage differences which might otherwise give rise to flashover or electric shock.

Furse earthing and equipotential bonding products offer the surest solution to this problem.

From pipe clamps and metalwork bonds to connect to accessible metal parts, to low resistance copper conductor and high quality earth rods for the earthing arrangement - Furse products are designed to perform.

And where our standard range doesn't quite fit your requirements, with full design and manufacturing capability we can design a special component to suit.

Special component design and manufacture

Our standard range is designed to meet the vast majority of earthing applications. However, on occasion, you may have the need for a non-standard part, for example where connecting large copper cable or tape to a rod, or to metalwork.

Where this is the case, our technical engineering team can design a special component to your needs, which on approval can be manufactured in the quantity specified for the project.



6



Earthing

Product selection guide

Product selection guide - Earthing

No.	Type	Section / Page No.
1.	Conductors	3/1
2.	Earth rods	7/4
3.	Earth plates	7/10
4.	FurseWELD exothermic welding	9/2
5.	Compression connectors	8/23
6.	Mechanical clamps	8/2
7.	Earth inspection pits	7/9
8.	Earth bars	8/18
9.	Earth electrode backfills	7/11

Earthing

6

An effective earthing system is a fundamental requirement of any modern structure or system for operational and/or safety reasons. Without such a system, the safety of a structure, the equipment contained within it and its occupants are compromised.

Earthing systems typically fall into (but are not limited to) one of the following categories:

- Power generation, transmission and distribution
- Lightning protection
- Control of undesirable static electricity
- Telecommunications

The following schematic illustrates the key elements of an effective earthing system.

Conductors and earth electrodes

As with lightning protection, the first choice faced by the designer of an earthing system is the type of conductor to be used. The correct choice of conductor is extremely important, whether it be a simple below ground electrode or a complex computer room signal reference grid.



1. Conductors

We offer three types of conductor:

- Flat tape
- Solid circular
- Stranded cable

It is important that earthing conductors should be correctly sized for their application, as they may be required to carry a considerable current for several seconds. A range of conductor materials is available. Above ground, copper, aluminium and steel may be used. Below ground, copper is the most common choice due to its high resistance to corrosion.

In addition to the conductors, earth rods and plates or any combination thereof can be used to achieve an effective earth depending on the site conditions.

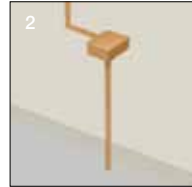

2. Earth rods

Earth rods take advantage of lower resistivity soils at greater depths than normal excavation will allow.

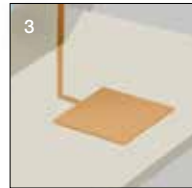

3. Earth plates

Earth plates are used to attain an effective earth in shallow soils with underlying rocks or in locations with large amounts of buried services. They can also provide protection at potentially dangerous places e.g. HV switching positions.

Main aspects and individual components of an earthing system

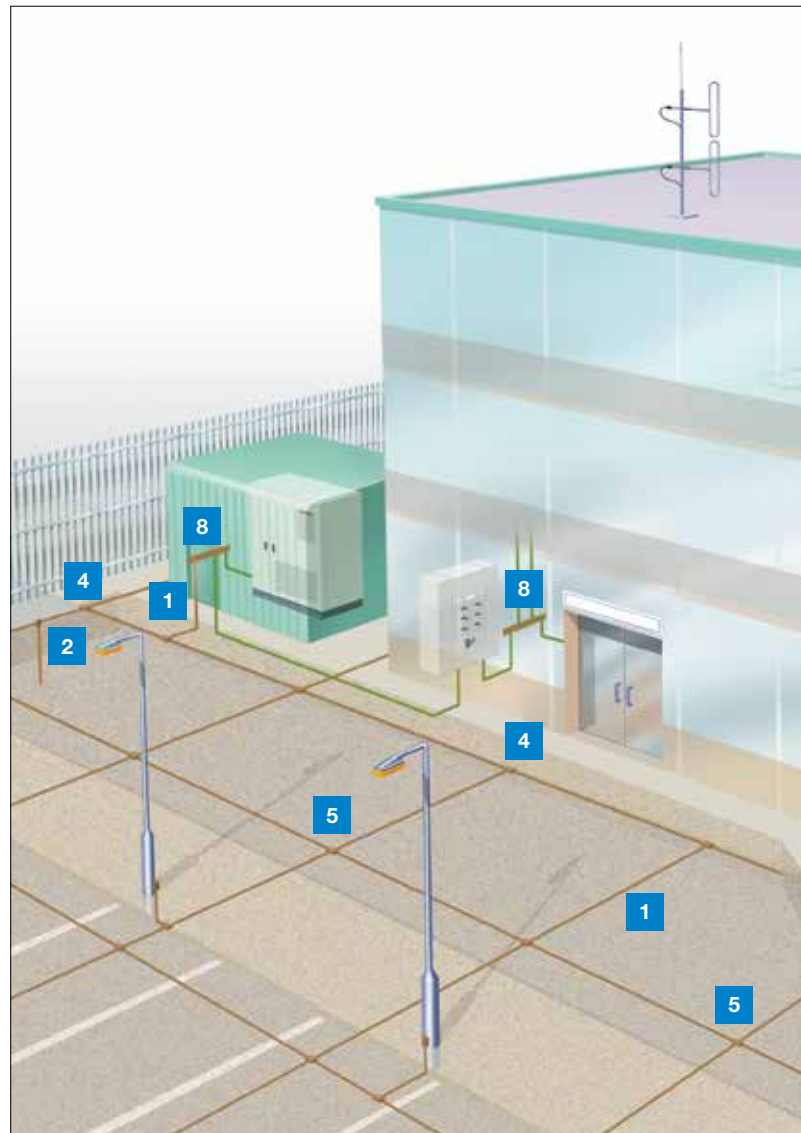

Connectors and terminations

An effective earthing system relies on joints and connections to have good electrical conductivity with high mechanical strength. Poorly chosen or badly installed joints and connectors can compromise the safe operation of an earthing system. We offer a range of connectors and termination methods to suit a wide range of applications:



4. FurseWELD exothermic welding

A simple, self-contained method of forming high quality electrical connections which requires no external power or heat source. Connections are made using the high temperature reaction of powdered copper oxide and aluminium.

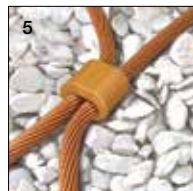

5. Compression connectors

For applications where exothermic welding is not appropriate for creating permanent connections, compression connectors may be used.

Compression connectors produce very robust joints which can be buried in the ground or in concrete.

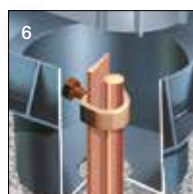

6. Mechanical clamps

Where permanent connections are not appropriate, mechanical clamps offer the ideal solution. These are typically used on smaller scale installations where periodic disconnection for testing is required.

All Furse mechanical clamps are manufactured from high copper content alloy. They have high mechanical strength, excellent corrosion resistance and conductivity.

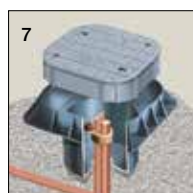

7. Earth inspection pits

Regular inspection and testing of the earthing system is essential. Inspection pits allow easy access to earth electrodes and conductors to facilitate this procedure.

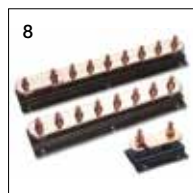

8. Earth bars

Earth bars are an efficient and convenient way of providing a common earth point. Integral disconnecting links mean the earth bars can be isolated for testing purposes.



9. Earth electrode backfills

Earth electrode backfills are to be used in areas where required resistance levels are difficult to achieve. These products effectively act to increase the electrode's surface area thus lowering its resistance to earth.

This illustration is designed to demonstrate the main aspects and individual components of an earthing system. It is not intended to represent an actual scheme conforming to a particular code of practice. The drawing is not to scale.





Earth electrodes

Earth electrodes

Introduction	7/2
--------------	-----

Earth rods

Threaded copperbond earth rod	7/4
Unthreaded copperbond earth rod	7/5
Solid copper & stainless steel earth rod	7/6
Earth rod seal	7/7

Earth hammer & rig

Earth rod hammer	7/8
Hammer rig	7/8

Inspection pits

Lightweight inspection pit	7/9
Concrete inspection pit	7/9

Earth plate & lattice

Earth plate (solid copper)	7/10
Earth mat (lattice copper)	7/10

Backfill materials

FurseCEM [®] conductive aggregate	7/11
Bentonite moisture retaining clay	7/11

Earth resistance test equipment

DET-14C clamp-on earth resistance tester	7/12
DET3TC digital earth resistance tester	7/12
DET4TD2 digital earth resistance tester	7/12
DET2/2 digital earth resistance tester	7/12

Earth electrodes

Introduction



Three types of Furse earth rod are available, but the copperbonded steel cored rod is by far the most popular, due to its combination of strength, corrosion resistance and comparatively low cost.

Quality earth rods are commonly made from either solid copper, stainless steel or copperbonded steel.

Solid copper and stainless steel rods offer a very high level of corrosion resistance at the expense of lower strength and higher cost.

Copperbond rod

Furse copperbond earth rods probably offer to the installer the best and most economical earth rods available. They are made by molecularly bonding 99.9% pure electrolytic copper on to a low carbon steel core. **Furse rods are not of the sheathed type.** They are highly resistant to corrosion, and because the steel used has a very high tensile strength, they can be driven by power hammers to great depths.

The counter-bored couplings are made from high copper content alloy, **commercial brass is not used.** This again ensures excellent corrosion resistance and high strength.

Solid copper rod

Furse solid copper earth rods offer greater resistance to corrosion. They are ideally used in applications where soil conditions are very aggressive, such as soils with high salt content.

Stainless steel rod

Stainless steel rods are used to overcome many of the problems caused by galvanic corrosion which can take place between dissimilar metals buried in close proximity. Furse stainless steel earth rods are highly resistant to corrosion.



Diameter of rod

One common misconception is that the diameter of the rod has a drastic effect on lowering earth resistance. This is not true! As the graph shows, you only lower the resistance value by 9.5% by doubling the diameter of the rod (which means increasing the weight and the cost of the rod by approximately 400%).

Thus the rationale is: Use the most economical rod that soil conditions will allow you to drive. This is one of the ways to ensure that you don't waste money on over-dimensioned rods.

Effect of electrode diameter on resistance

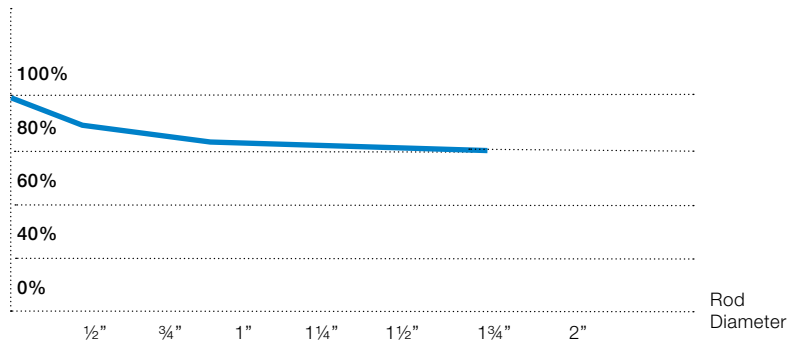

Thread and shank diameters

Confusion often arises between thread and shank diameters for threaded rods.

The thread rolling process, used by quality rod manufacturers, raises the surface of the rod so that thread diameter (B) is greater than shank diameter (A) (see drawing).

All threads are Unified National Coarse (UNC-2A).

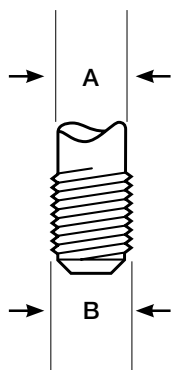

Earth electrodes

Earth rods



Threaded copperbond earth rod

Part no.	Nominal diameter (")	Length (mm)	Thread 'B' UNC (")	Shank 'A' (mm)	Weight each (kg)
RB105	0½	1,200	¼	12.7	1.18
RB110	0½	1,500	¼	12.7	1.55
RB115	0½	1,800	¼	12.7	1.76
RB125	0½	2,400	¼	12.7	2.36
RB205-FU	0¾	1,200	⅜	14.2	1.53
RB210	0¾	1,500	⅜	14.2	1.88
RB215	0¾	1,800	⅜	14.2	2.29
RB220-FU	0¾	2,100	⅜	14.2	2.51
RB225	0¾	2,400	⅜	14.2	3.00
RB235	0¾	3,000	⅜	14.2	3.79
RB305	0¾	1,200	¾	17.2	2.19
RB310	0¾	1,500	¾	17.2	2.73
RB315	0¾	1,800	¾	17.2	3.27
RB320-FU	0¾	2,100	¾	17.2	3.83
RB325	0¾	2,400	¾	17.2	4.35
RB335	0¾	3,000	¾	17.2	5.44

– High tensile low carbon steel core with minimum 250 microns of copper

Fittings

Part no.	Type (")	Weight (kg)
CG170	½ Coupling	0.09
CG270	¾ Coupling	0.08
CG370	¾ Coupling	0.13
ST100	½ Driving stud	0.05
ST200	¾ Driving stud	0.08
ST300	¾ Driving stud	0.12

Standards

IEC/BS EN 62561-2
BS 7430



UL467 (RB125, RB225, RB235, RB325, RB335, CG270, CG370)

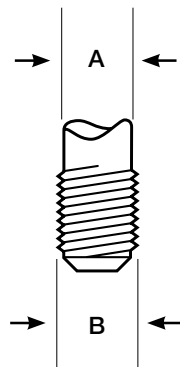

Earth electrodes

Earth rods

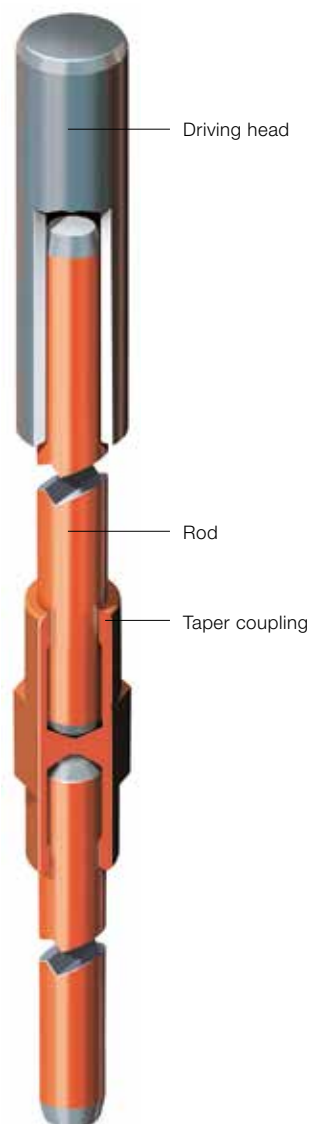

Unthreaded copperbond earth rod

Part no.	Diameter (mm)	Length (mm)	Weight each (kg)
RB005	Ø 9.0 mm	1200 mm	0.62
RB103	Ø 12.7 mm	1200 mm	1.18
RB107	Ø 12.7 mm	1500 mm	1.55
RB116	Ø 12.7 mm	1800 mm	1.76
RB126	Ø 12.7 mm	2400 mm	2.36
RB203	Ø 14.2 mm	1200 mm	1.53
RB213	Ø 14.2 mm	1500 mm	1.88
RB216	Ø 14.2 mm	1800 mm	2.29
RB217	Ø 14.2 mm	2000 mm	2.51
RB223	Ø 14.2 mm	2100 mm	2.68
RB226	Ø 14.2 mm	2400 mm	3.00
RB236	Ø 14.2 mm	3000 mm	3.79
RB306	Ø 17.2 mm	1200 mm	2.19
RB313	Ø 17.2 mm	1500 mm	2.73
RB316	Ø 17.2 mm	1800 mm	3.27
RB317	Ø 17.2 mm	2000 mm	3.64
RB323	Ø 17.2 mm	2100 mm	3.83
RB326	Ø 17.2 mm	2400 mm	4.35
RB336	Ø 17.2 mm	3000 mm	5.44

– High tensile low carbon steel core with minimum 250 microns of copper

Fittings

Part no.	Type	Weight each (kg)
CG177	12.7 mm Coupling	0.09
CG277	14.2 mm Coupling	0.08
CG377	17.2 mm Coupling	0.13
ST107	12.7 mm Driving head	0.25
ST207	14.2 mm Driving head	0.22
ST307	17.2 mm Driving head	0.27

Standards

BS 7430

UL467 (RB126, RB226,
RB236, RB326, RB336)



Earth electrodes

Earth rods

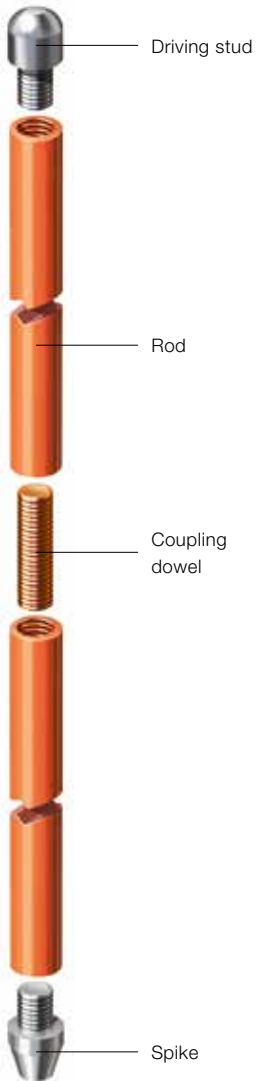

Solid copper and stainless steel earth rod

Part no.	Diameter (mm)	Length (mm)	Weight each (kg)
Solid copper rod			
RC010	Ø 15	1200	1.88
RC011	Ø 15	1500	2.35
RC012	Ø 15	3000	4.70
RC015	Ø 20	1200	3.34
RC016	Ø 20	1500	4.18
RC017	Ø 20	3000	8.36
Solid copper rod kit			
RC010-KIT	Ø 15	8 ft (2440 mm)	3.82
RC015-KIT	Ø 20	8 ft (2440 mm)	6.79
Stainless steel rod			
RS005	Ø 16	1200	1.87
RS011	Ø 16	1500	2.34
RS012	Ø 16	3000	4.68
RS016	Ø 20	1500	3.65
RS017	Ø 20	3000	7.30
Stainless steel rod kit			
RS005-KIT	Ø 16 mm	8 ft (2440 mm)	3.80 kg

Fittings

Part no.	Type	Weight each (kg)
ST010	15 mm hardened steel driving stud for copper/stainless steel rod	0.02
ST015	20 mm hardened steel driving stud for copper/stainless steel rod	0.05
CG013	Coupling dowel for 15 mm & 20 mm copper rod	0.02
CG005	Coupling dowel for 16 mm & 20 mm stainless steel rod	0.02
SP010	15 mm hardened steel spike for copper/stainless steel rod	0.02
SP015	20 mm hardened steel spike for copper/stainless steel rod	0.04

Standards

BS EN 50164-2
BS 7430

UL467 (RC010-KIT,
RC015-KIT,
RS005-KIT)



Earth electrodes

Earth rod seal



Standards

IEC/BS EN 62561-5



Earth rod seal

Part no.	Description	Weight each (kg)
Earth rod seal assembly		
ES300	Earth rod seal and membrane seal	0.75
Earth rod seal pack		
ES300-12	Seal pack for 1/2" (ø 12.7 mm) Copperbond rod	0.06
ES300-58	Seal pack for 5/8" (ø 14.2 mm) Copperbond rod	0.06
ES300-34	Seal pack for 3/4" (ø 17.2 mm) Copperbond rod	0.06
ES300-15	Seal pack for ø 15 mm solid copper rod	0.06
ES300-16	Seal pack for ø 16 mm solid copper rod	0.06
ES300-20	Seal pack for ø 20 mm solid copper rod	0.06
Earth rod seal tube		
ES310-03	Seal tube, 300 mm length	0.16
ES310-05	Seal tube, 500 mm length	0.27
ES310-10	Seal tube, 1,000 mm length	0.54
ES310-15	Seal tube, 1,500 mm length	0.81
ES310-20	Seal tube, 2,000 mm length	1.08
ES310-30	Seal tube, 3,000 mm length	1.62
Accessory spanner set		
ES320	Membrane seal torque spanner set	0.45

- When specifying a Furse earth rod seal, ensure that all relevant components are ordered - earth rod assembly, seal pack, seal tube, accessory spanner set and lightweight inspection pit. The accessory spanner set may be used for multiple earth rod seal installations
 - Please specify the correct size of earth rod seal pack for the earth rod, and the correct length of protective seal tube when ordering
- Note: earth rod seal designed for use with clean, smooth Type 'A' damp proof membranes as defined by BS EN 13967, without the need for adhesive, sealant or mastic. For uneven, textured or tanking damp proof membranes, if installed, or where hydrostatic conditions exist, adhesive, sealant or mastic should be applied

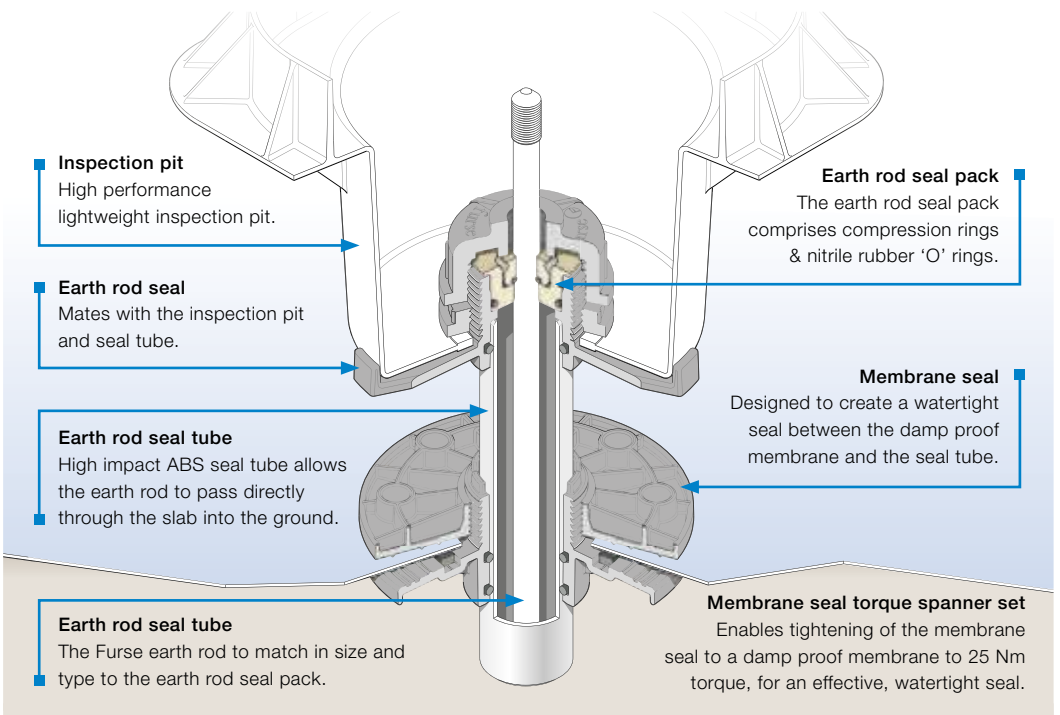

Earth electrodes

Earth hammer & rig



Earth rod hammer

Part no.	Description	Weight each (kg)
HM005	Atlas Copco Cobra TT petrol driven hammer	24.00
HM010	Earth rod adapter (Suitable for 5/8" earth rods)	3.00

– For projects where hand driving is uneconomical owing to a large quantity of rods or unfavourable ground conditions, the earth rod hammer can drastically cut installation times

7



Hammer rig

Part no.	Description	Weight each (kg)
HM105	Hammer rig	196.35

– By mounting a hammer onto a rig, longer lengths of earth rods can be driven. For projects where large quantities of rods are required cost savings can be achieved, for example, by using single 8 ft rods rather than 2 x 4 ft rods which would need couplers etc.
 – Installation time is also considerably reduced. Please specify length of rod to be driven and type of hammer to be used when ordering.

Earth electrodes

Inspection pits



Lightweight inspection pit

Part no.	Description	Load rating (kg)	Weight each (kg)
PT205	Lightweight inspection pit with grey polymer lid	5000	1.80
PT309-FU	Lightweight inspection pit with black (unbranded) polymer lid	5000	1.80
PT110*	Lightweight inspection pit with concrete lid	1200	7.50

Earth bar for lightweight inspection pit

PT004	5 hole earth bar		0.40
-------	------------------	--	------

Accessories for polymer lid

AK005	6 mm Allen key		0.03
-------	----------------	--	------

Accessories for concrete lid

JH100	M8 x 100 mm long mild steel 'J' bolt lifting hook		0.04
AS100	M8 x 60 stainless steel Allen caphead screw (2 per lid)		0.03

- Manufactured from high-performance, UV stable and chemically resistant polymer with either polymer or concrete lid to suit the application
- The lightweight inspection pit with polymer lid is load rated to 5,000 kg and is suitable for general to heavy duty use. It has a lockable lid and improved working area compared to the concrete inspection pit. The lightweight inspection pit with concrete lid is load rated to 1,200 kg and is designed for use in pedestrianized and light vehicular areas. The lid can be locked in place, if required order 2 x AS100 Allen caphead screws

*Not illustrated (drawing available on request)

Standards

IEC/BS EN 62561-5

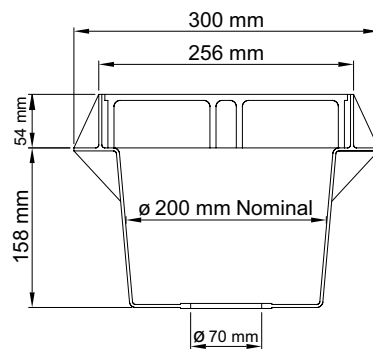

Concrete inspection pit

Part no.	Description	Weight each (kg)
PT005	Concrete inspection pit	30.00

Earth bars for concrete inspection pit

PT005	Concrete inspection pit	30.00
-------	-------------------------	-------

Accessories

PT006	5 hole earth bar	0.40
PT007	7 hole earth bar	0.58

- The concrete inspection pit is load rated to 3,500 kg and is suitable for most types of earthing and lightning protection installations
- It is not suitable for use in areas where high load, small wheel vehicles are used. The lightweight inspection pit (PT205) is recommended for this type of application

Standards

BS EN 62561-5

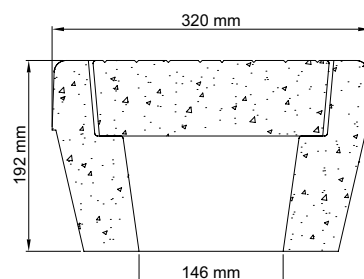

Earth electrodes

Earth plate & lattice



Earth plate (solid copper)

Part no.	Dimensions (mm)	Total surface area (m ²)	Weight each (kg)
PE005	600 x 600 x 1.5	0.72	5.00
PE015	900 x 900 x 1.5	1.63	11.21
PE010	600 x 600 x 3	0.73	9.74
PE020	900 x 900 x 3	1.63	21.74

Standards

BS EN 12163

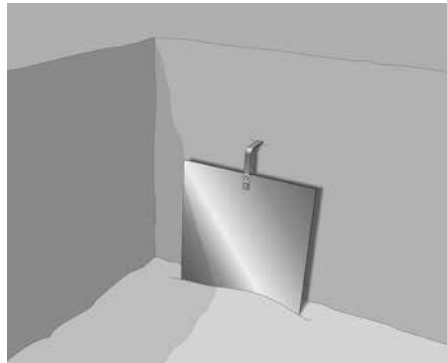

– Solid copper earth plates offer a simple alternative style of earth electrode where high resistivity soil or rock conditions prohibit the driving of earth rods

7



Earth mat (lattice copper)

Part no.	Dimensions (mm)	Total surface area (m ²)	Weight each (kg)
PE110	600 x 600 x 3	0.31	3.98
PE120	900 x 900 x 3	0.65	7.20

Standards

BS EN 13601

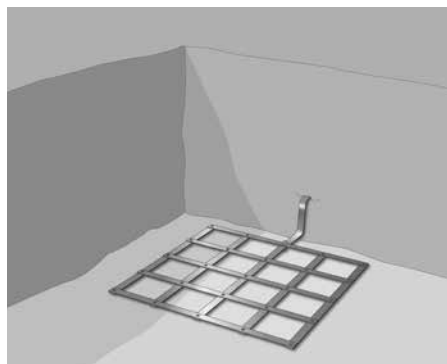

– Manufactured from high conductivity copper tape, lattice earth mats are designed to minimize the danger of exposure to high step and touch voltages to operators in situations such as High Voltage switching

Earth electrodes

Backfill materials



Standards

BS EN 50164-7

FurseCEM® conductive aggregate

Part no.	Description	Weight each (kg)
CM025	FurseCEM®	25.00
CM030	FurseCEM® (supplied with cement)	25.00

- Certain ground conditions make it difficult to obtain a reliable earth resistance, whilst particular installations may require a very low resistance. In such cases, FurseCEM® provides a convenient and permanent solution. By adding FurseCEM® in place of sand and aggregate, to cement, a conductive concrete is formed. This electrically conductive medium has many applications in the electrical/ construction industry, including RF and microwave screening, static control and, of course, earthing, for which it was specifically developed
- When used as a backfill for earth electrodes, FurseCEM® impregnated concrete greatly increases the electrode's surface area thus lowering its resistance to earth

For further information on FurseCEM®, please contact the Furse sales office. A separate datasheet available on request.

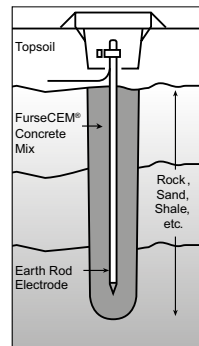

Bentonite moisture retaining clay

Part no.	Description	Weight each (kg)
CM015	Bentonite powder	25.00
CM020	Bentonite granules	25.00

- Used as an earth-electrode backfill to reduce soil resistivity by retaining moisture. The clay is a sodium activated montmorillonite, which when mixed with water swells to many times its dry volume. It has the ability to hold its moisture content for a considerable period of time and to absorb moisture from the surrounding soil (e.g. from rainfall)
- CoSHH datasheet available on request

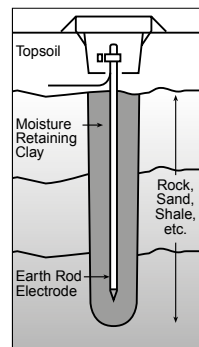

Earth electrodes

Earth resistance test equipment



Clamp-on earth resistance tester

Part no.	Description	Weight each (kg)
DET14C	Clamp-on earth resistance tester	0.75

- Measures earth/ground resistance and current flow by the clamp-on method
- Capable of taking ground resistance readings from 0.05 Ω to 1500 Ω
- Capable of measuring ground leakage current from 0.5 mA to 35 A
- Extra large 39 mm jaws



Digital earth resistance tester

Part no.	Description	Weight each (kg)
DET3TC	Digital earth resistance tester	1.0
DET4TD2	Digital earth resistance tester	1.0

- DET3TC three-terminal digital model includes Attached Rod Technique (ART) capability
- DET3TC measures ground resistance from 0.01 Ω to 2000 Ω and earth voltages up to 100 V
- With optional clamp, the DET3TC can read ground current from 0.5 mA to 19.9 A
- DET4TD2 capable of 2 pole, 3 pole and 4 pole testing
- DET4TD2 measures ground resistance from 0.01 Ω to 20,000 Ω and includes a voltmeter to measure ground voltages up to 100 V



Digital earth resistance tester

Part no.	Description	Weight each (kg)
DET2/2	Digital earth resistance tester	5.0

- Four-terminal digital model for large, critical ground systems
- Includes an extra digit of resolution (to 0.001) on readings, together with an interference filter, test current control and, most importantly, adjustable test current frequency (105-160 Hz)
- Can be used to make earth resistivity measurements



Earthing

Earth bonds & clamps

Mechanical clamps

Rod to tape clamp (type A)	8/2
Rod to cable clamp (type G)	8/2
'U' bolt rod clamp (type E)	8/3
'U' bolt rod clamp (type GUV)	8/3
Rod to cable clamp (type B)	8/4
Rebar clamp	8/4
Rebar to rebar connecting clip	8/5
Rebar to conductor connecting clip	8/5

Earth points

Single hole earth point	8/6
Two hole earth point	8/7
Four hole earth point	8/7

Earth bosses

Earth boss	8/9
------------	-----

Bonds & clamps

Type H high strength splitbolt connector	8/8
Tower earth clamp	8/10
B bond	8/10
Metalwork bond	8/11
Straight setscrew cable socket	8/11
RWP bond	8/12
Watermain bond	8/12

Pipe bonds & clamps

Pipe bond	8/13
Pipe clamp	8/13

Flexible braid bonds

Flexible flat copper braid bond	8/14
Flexible circular copper braid bond	8/15

Static earth connection points

Eyebolt	8/16
Static earth receptacle	8/16

Static earth clamps

Stainless steel earthing clamp	8/17
Stainless steel earthing clamp & reel	8/17

Earth bars

Introduction	8/18
Earth bar	8/19
Earth bar with single disconnecting link	8/20
Earth bar with twin disconnecting link	8/21

Earth bar accessories

Swan-neck link	8/22
Disconnecting link	8/22
Insulator	8/22

Compression connectors

'C' shape connector - Copper	8/23
'C' shape connector - Tinned copper	8/24

Cable lug

Tinned copper cable lug	8/25
-------------------------	------

Compression connector dies

'C' shape connector die	8/26
-------------------------	------

Compression tools

Hydraulic crimping tool	8/27
Hydraulic crimping head and pump	8/27
Battery powered hydraulic crimping tool	8/28
Battery powered hydraulic cutting tool	8/28

Earth bonds & clamps

Mechanical clamps



Rod to tape clamp (type A)

Part no.	Nominal rod diameter (")	(mm)	Max. conductor (mm)	Weight each (kg)
CR105	0 1/2	Ø 12.7	26 x 12	0.15
CR105	0 3/4	Ø 16	26 x 12	0.15
CR105	0 1	Ø 20	26 x 10	0.15
CR108	0 3/4	Ø 16	30 x 2	0.16
CR108	0 1	Ø 20	30 x 2	0.16
CR110	0 3/4	Ø 16	40 x 12	0.24
CR115	0 3/4	Ø 16	51 x 8	0.30
CR125	0 1	Ø 20	51 x 12	0.30
CR130	0 1/2	Ø 12.7	26 x 20	0.23
CR130	0 3/4	Ø 16	26 x 18	0.23
CR130	0 1	Ø 20	26 x 10	0.23
CR130	0 1 1/4	Ø 25	26 x 10	0.23

Standards

IEC/BS EN 62561-1 Class H
BS 7430

UL467 (CR105)



- Designed for connection of flat tape conductor to an earth rod. Corrosion resistance, conductivity and mechanical strength are essential considerations in clamp design to ensure an earthing system remains operative for many years. All Furse earth rod clamps have high strength copper alloy bodies and screws e.g. aluminium bronze, phosphor bronze etc., commercial brass is not used
- Tightening torque 15 Nm

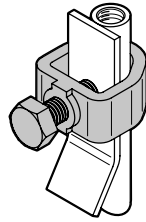

8



Rod to cable clamp (type G)

Part no.	Nominal rod diameter (")	(mm)	Max. conductor (mm ²)	Weight each (kg)
CR505	0 3/4	Ø 9.5	6-35	0.03
CR510-FU*	0 1/2	Ø 12.7	16-50	0.05
G5	0 3/4	Ø 16	5.2-33.6	0.06
CR515*	0 3/4	Ø 16	16-70	0.06
G6	0 1	Ø 20	5.2-33.6	0.06
CR520*	0 1	Ø 20	35-95	0.06
CR525	0 1 1/4	Ø 25	70-150	0.14

Standards

BS EN 62561-1 Class H
BS 7430

UL 467 (G5 & G6)



- High strength copper alloy clamp designed to provide a high quality, low resistance connection between solid circular or stranded conductor and an earth rod
- Tightening torque 12 Nm
- *Suitable for use with Ø 8 mm solid circular copper conductor

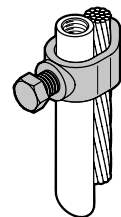

Earth bonds & clamps

Mechanical clamps



'U' bolt rod clamp (type E)

Part no.	Nominal rod/ rebar diameter (")	(mm)	Hole centres (mm)	Tape width (mm)	Weight each (kg)
CR305	Ø 5/8	Ø 16	37	–	0.20
CR310	Ø 3/4	Ø 20	37	–	0.20
CR315	Ø 1	Ø 25	37	–	0.20
CR320*	Ø 5/8	Ø 16	37	25	0.26
CR325	Ø 1 1/2	Ø 38	54	–	0.37
CR330	Ø 2	Ø 50	64	–	0.44
CR326	Ø 1 1/2	Ø 38	54	25	0.43

Standards

IEC/BS EN 62561-1 Class H
BS 7430

- High strength copper alloy 'U' bolt clamp designed to provide a high quality, low resistance connection between flat tape or stranded conductor and earth rod or rebar. 'U' Bolt threaded M10
- *CR320 includes additional plate to allow tape to be clamped without drilling

UL 467 (CR305)

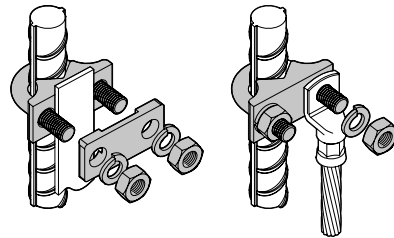

'U' bolt rod clamp (type GUV)

Part no.	Nominal rod/ rebar diameter (")	(mm)	Conductor range (mm²)	Weight each (kg)
CR700*	Ø 5/8	Ø 16	16-95	0.39
CR700*	Ø 3/4	Ø 20	16-70	0.39
CR705	Ø 5/8	Ø 16	70-185	0.39
CR705	Ø 3/4	Ø 20	70-150	0.39
CR730	Ø 5/8	Ø 16	150-300	0.62
CR730	Ø 3/4	Ø 20	150-300	0.62
CR710	Ø 1	Ø 25	16-70	0.39
CR740	Ø 1	Ø 25	70-150	0.39
CR750	Ø 1	Ø 25	150-300	0.62

Standards

IEC/BS EN 62561-1 Class H
BS 7430

- High strength copper alloy 'U' bolt clamp designed to provide a high quality, low resistance connection between solid circular or stranded conductor and an earth rod or rebar
- Tightening torque 12 Nm
- * Suitable for use with Ø 8 mm solid circular copper conductor

UL 467 (CR700,
CR705, CR730)

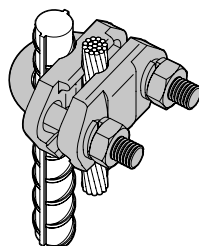

Earth bonds & clamps

Mechanical clamps



Rod to cable clamp (type B)

Part no.	Nominal rod diameter (")	mm	Rod type	Bolt size	Weight each (kg)
CR205	0 3/8	Ø 9.5	Copperbond	M8	0.09
CR215	0 1/2	Ø 16	Copperbond	M10	0.30
CR220	0 3/4	Ø 15	Solid copper	M10	0.30
CR225	0 7/8	Ø 20	Copperbond	M10	0.30
CR230	0 7/8	Ø 20	Solid copper	M10	0.30

– High strength copper alloy cable lug clamp designed to provide a high quality, low resistance connection between stranded conductor and earth rod

Standards

IEC/BS EN 62561-1 Class H
BS 7430

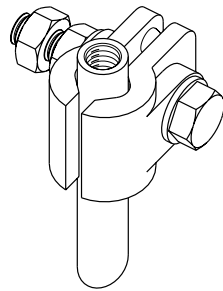

8



Rebar clamp

Part no.	Conductor size (mm)	Rebar diameter (mm)	Conductor material	Weight each (kg)
BN150	Ø 8	Ø 8-18	Copper	0.32
BN155	Ø 8	Ø 18-38	Copper	0.75

– High strength copper alloy rebar clamp for bonding to reinforcing bars, steam pipes, handrails etc.
– Tightening torque 15 Nm (BN155 - M10); 5 Nm (BN155 - M6)

Standards

BS 7430

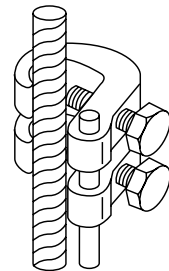

Earth bonds & clamps

Mechanical clamps



Rebar to rebar connecting clip

Part no.	Maximum rebar diameter (A) (mm)	Maximum rebar diameter (B) (mm)	Weight each (kg)
RR812	Ø 8	Ø 12	0.05
RR1616	Ø 16	Ø 16	0.05
RR2121	Ø 20	Ø 20	0.06
RR2626	Ø 25	Ø 25	0.07
RR3232	Ø 32	Ø 32	0.07
RR3838	Ø 40	Ø 40	0.08

Standards

IEC/BS EN 62561-1 Class H
BS 7430

- Manufactured from high quality stainless steel for excellent corrosion resistance. Simple to install, providing a secure connection between internal reinforcing bars
- Tightening torque 12 Nm

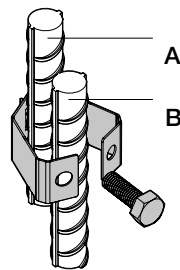

Rebar to conductor connecting clip

Part no.	Rebar diameter (mm)	Conductor size	Weight each (kg)
Rebar to flat tape			
RC25-087095	Ø 25	25 x 3 mm	0.07
Rebar to stranded/solid circular conductor			
RC812-0850	Ø 12	50 mm ² or Ø 8 mm	0.05
RC16-087095	Ø 16	Ø 8 mm dia., 50-70-95 mm ²	0.06
RC20-087095	Ø 20	Ø 8 mm dia., 50-70-95 mm ²	0.07
RC25-087095	Ø 25	Ø 8 mm dia., 50-70-95 mm ²	0.07
RC32-087095	Ø 32	Ø 8 mm dia., 50-70-95 mm ²	0.07
RC40-087095	Ø 40	Ø 8 mm dia., 50-70-95 mm ²	0.08

Standards

BS EN 62561-1 Class H
BS 7430

- Manufactured from high quality stainless steel for excellent corrosion resistance. Simple to install, providing a secure connection between internal reinforcing bars and flat tape, solid circular or stranded conductor
- Tightening torque 12 Nm

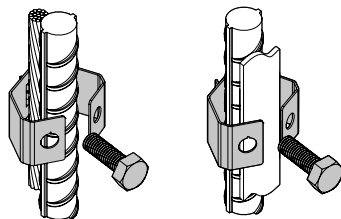

Earth bonds & clamps

Earth points

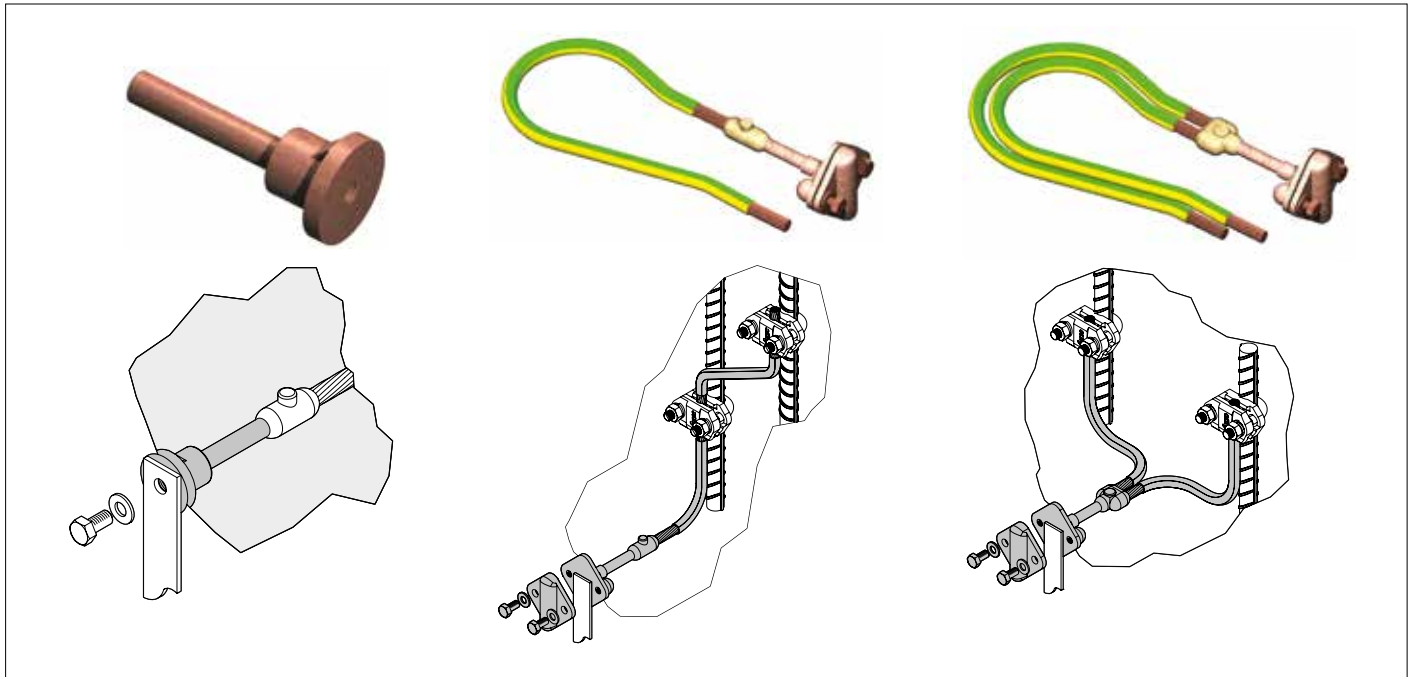

8

Earth points

Furse earth points are available for direct connection to conductors, or with additional pre-welded tail (single or double 70 mm² PVC insulated cable) to enable connection to internal rebar arrangements via mechanical clamps (see product tables for individual product availability).



Single hole earth point

Part no.	Hole size (mm)	Length (mm)	Weight each (kg)
PC100-FU	M8 x 15	80	0.14
PC101	M10 x 15	80	0.14
PC102	M12 x 15	80	0.14
PC103	M16 x 15	80	0.14

Standards

BS EN 50164-1 Class H
BS 7430

UL96 (PC105, PC106,
PC107, PC108)

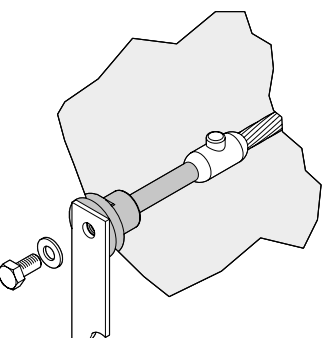

Part no.	Description	Weight each (kg)
Single hole earth point with single pre-welded tail		
PC105	PC100-FU earth point with pre-welded 500 earth cable	0.56
PC106	PC101 earth point with pre-welded 500 earth cable	0.56
PC107	PC102 earth point with pre-welded 500 earth cable	0.56
PC108	PC103 earth point with pre-welded 500 earth cable	0.56

- Stem diameter = 10.7 mm (70 mm²)
- Tightening torque 8 Nm

Earth bonds & clamps

Earth points

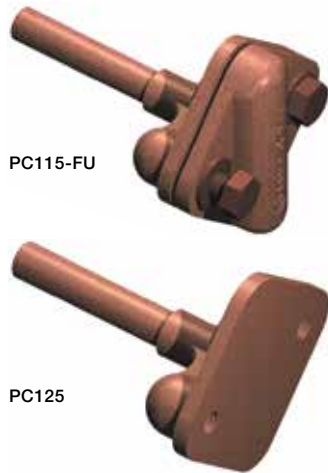

PC115-FU

PC125

Two hole earth point

Part no.	Description	Hole size (mm)	Length (mm)	Weight each (kg)
PC115-FU	Supplied c/w front plate for connection of 25 mm x 3 mm copper tape or 70 mm ² stranded copper cable	M8 x 12	80	0.44
PC120	Supplied c/w front plate for connection of 25 mm x 3 mm copper tape or 8 mm Ø solid circular copper	M8 x 12	80	0.44
PC125	Supplied without front plate	M8 x 12	80	0.28

Two hole earth point with single pre-welded tail

PC116	PC115-FU earth point with pre-welded 500 mm earth cable			0.84
PC121	PC120 earth point with pre-welded 500 mm earth cable			0.84
PC126-FU	PC125 earth point with pre-welded 500 mm earth cable			0.84

Two hole earth point with double pre-welded tail

PC216	PC115-FU earth point with pre-welded 2 x 500 mm earth cable			1.26
PC221	PC120 earth point with pre-welded 2 x 500 mm earth cable			1.26

– Stem Ø = 10.7 mm (70 mm²)

– Tightening torque 8 Nm

Standards

IEC/BS EN 62561-1 Class H
BS 7430

UL96 (PC116, PC121,
PC126-FU, PC216)

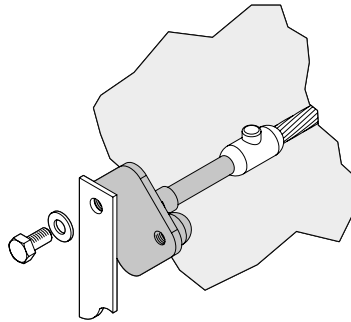

Four hole earth point

Part no.	Description	Hole size (mm)	Length (mm)	Weight each (kg)
PC110	Earth point only	M8 x 14	75	0.41

Four hole earth point with single pre-welded tail

PC111	PC110 earth point with pre-welded 500 mm earth cable			1.14
-------	--	--	--	------

Four hole earth point with double pre-welded tail

PC211*	PC110 earth point with pre-welded 2 x 500 mm earth cable			1.23
--------	--	--	--	------

– Stem Ø = 10.7 mm (70 mm²)

– Tightening torque 12 Nm

Standards

BS EN 50164-1 Class H
BS 7430

UL96 (PC111, PC211)

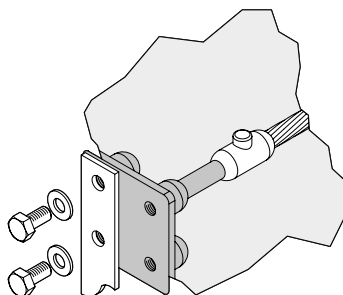

Earth bonds & clamps

Splitbolt connector



Type H high strength splitbolt connector

Part no.	Conductor range				Dimension (B) (mm)	Weight each (kg)
	Main min (mm ²)	Main max (mm ²)	Tap min (mm ²)	Tap max (mm ²)		
8H-FU	4	10	2.5	10	4.1	0.02
4H-FU	10	16	2.5	16	5.5	0.03
2H-FU	16	25	4	25	6.9	0.04
1H-FU	25	35	4	35	8.4	0.06
10H-FU	35	50	4	50	9.7	0.09
20H-FU	35	70	4	70	11.2	0.14
30H-FU	50	95	4	95	13.6	0.17
40H-FU	50	120	6	120	14.7	0.18
350M-FU	95	185	6	185	18.2	0.35

– For copper to copper connections. No special tools required. Tinned copper splitbolt connectors available on request

Standards

BS 7430

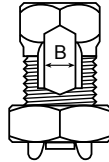
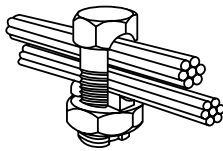

Earth bonds & clamps

Earth bosses



Earth boss

Part no.	Length (mm)	Diameter (mm)	Thread size	Material	Weight each (kg)
EB0000	25	Ø 25	M8	Mild steel	0.11
EB1000	25	Ø 25	M8	Stainless steel	0.11
EB0110	30	Ø 30	M8	Mild steel	0.18
EB1110	30	Ø 30	M8	Stainless steel	0.18
EB0111	30	Ø 30	M10	Mild steel	0.20
EB1111	30	Ø 30	M10	Stainless steel	0.20
EB0120	30	Ø 40	M8	Mild steel	0.24
EB1120	30	Ø 40	M8	Stainless steel	0.24
EB0121	30	Ø 40	M10	Mild steel	0.26
EB1121	30	Ø 40	M10	Stainless steel	0.26
EB0130	30	Ø 50	M8	Mild steel	0.29
EB1130	30	Ø 50	M8	Stainless steel	0.29
EB0131	30	Ø 50	M10	Mild steel	0.31
EB1131	30	Ø 50	M10	Stainless steel	0.31
EB0211	40	Ø 30	M10	Mild steel	0.33
EB1211	40	Ø 30	M10	Stainless steel	0.33
EB0212	40	Ø 30	M12	Mild steel	0.36
EB1212	40	Ø 30	M12	Stainless steel	0.36
EB0221	40	Ø 40	M10	Mild steel	0.43
EB1221	40	Ø 40	M10	Stainless steel	0.43
EB0222	40	Ø 40	M12	Mild steel	0.45
EB1222	40	Ø 40	M12	Stainless steel	0.45
EB0231	40	Ø 50	M10	Mild steel	0.53
EB1231	40	Ø 50	M10	Stainless steel	0.53
EB0232	40	Ø 50	M12	Mild steel	0.55
EB1232	40	Ø 50	M12	Stainless steel	0.55
EB0311	50	Ø 30	M10	Mild steel	0.50
EB1311	50	Ø 30	M10	Stainless steel	0.50
EB0312	50	Ø 30	M12	Mild steel	0.52
EB1312	50	Ø 30	M12	Stainless steel	0.52
EB0321	50	Ø 40	M10	Mild steel	0.65
EB1321	50	Ø 40	M10	Stainless steel	0.65
EB0322	50	Ø 40	M12	Mild steel	0.67
EB1322	50	Ø 40	M12	Stainless steel	0.67
EB001	50	Ø 50	M10	Mild steel	0.80
EB1331	50	Ø 50	M10	Stainless steel	0.80
EB0332	50	Ø 50	M12	Mild steel	0.80
EB1332	50	Ø 50	M12	Stainless steel	0.80

Standards

BS 7430

– Earth boss manufactured from mild steel (to 970 230M07 grade EN1A) or stainless steel (grade 316L) complete with stainless steel studs, nuts and washers - grade 316. For welding to steel vessels, tanks, structures etc. Wrap connections with Denso tape

Continuous 5 mm Fillet Weld

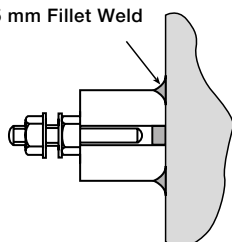

Earth bonds & clamps

Bonds & clamps



Tower earth clamp

Part no.	Conductor range (mm ²)	Channel thickness (mm)	Bolt size	Conductor material	Weight each (kg)
BN125*	16-70	10	M10	Copper	0.13
BN130	70-120	10	M12	Copper	0.22
BN300-FU*	25-50	10	M10	Copper	0.08
BN305*	25-50	10	M10	Aluminium	0.05
BN320	120-185	10	M12	Copper	0.30
BN325	185-240	10	M12	Copper	0.40

- For bonding copper cable or wire to steel structures
- Tightening torque 12 Nm
- * Suitable for use with Ø 8 mm solid circular conductor

Standards

BS EN 62561-1 Class H
BS 7430

8



B bond

Part no.	Maximum tape width (mm)	Bolt size	Conductor material	Weight each (kg)
BN105	26	M10	Copper	0.12
BN005	26	M10	Aluminium	0.06
BN113	31	M10	Copper	0.15
BN114	40	M10	Copper	0.18
BN117	50	M10	Copper	0.20

- For bonding tape to steel structures
- Tightening torque 17 Nm

Standards

IEC/BS EN 62561-1 Class H
BS 7430

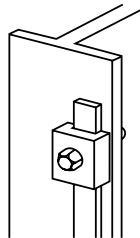

Earth bonds & clamps

Bonds & clamps

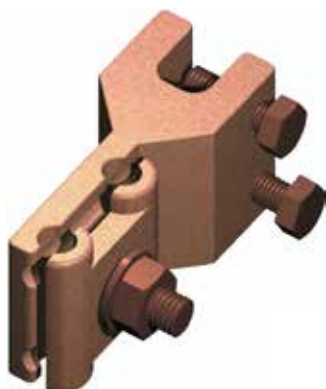

Metalwork bond

Part no.	Conductor size (mm)	Conductor material	Weight each (kg)
CS350	Ø 8	Copper	0.37
CS355	Ø 8	Aluminium	0.17

- For connecting to all types of metal structures up to 13 mm thickness
- Tightening torque - M8 bolt: 10 Nm, M10 bolt: 12 Nm

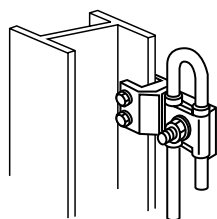

Standards

BS EN 62561-1 Class H
BS 7430



Straight setscrew cable socket

Part no.	Conductor size (mm)	Palm hole diameter (mm)	Conductor material	Weight each (kg)
SX450	Ø 8	12	Copper	0.11
SX455	Ø 8	12	Aluminium	0.05

- For bonding copper and aluminium conductors to steelwork
- Tightening torque 3 Nm

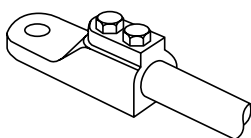

Standards

BS EN 62561-1 Class H

Earth bonds & clamps

Bonds & clamps



RWP bond

Part no.	Maximum tape width (mm)	Bolt size	Conductor material	Weight each (kg)
BN115	26	M10	Copper	0.12
BN010	26	M10	Aluminium	0.07

– For bonding tape to rainwater pipes, handrails etc.

Standards

BS 7430

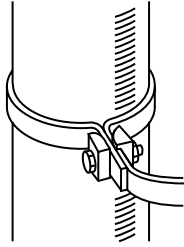

8



Watermain bond

Part no.	Maximum tape width (mm)	Conductor material	Weight each (kg)
BN120	26	Copper	0.26

– For bonding tape to large diameter pipes

Standards

BS 7430

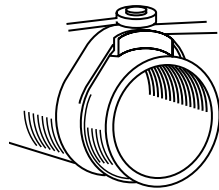

Earth bonds & clamps

Pipe bonds & clamps



Pipe bond

Part no.	Conductor size (mm)	Pipe diameter (mm)	Conductor material	Weight each (kg)
BN175	Ø 8	Ø 50-200	Copper	0.46
BN176	Ø 8	Ø 50-200	Aluminium	0.25

- For bonding to ducts and large diameter pipeworks. Additional lengths available to order
- Tightening torque - M6 bolt: 6 Nm, M10 bolt: 12 Nm

Standards

BS EN 62561-1 Class H
BS 7430

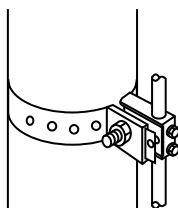

Pipe clamp

Part no.	Pipe diameter (")	Pipe diameter (mm)	Conductor range (mm ²)	Weight each (kg)
3902	Ø ½-1	Ø 13-25	25-95	0.3
3903	Ø 1¼-2	Ø 32-50	25-95	0.4
3904	Ø 2½-3½	Ø 65-90	25-95	0.5
3905-TB	Ø 4-5	Ø 100-125	25-95	0.6
3906-TB	Ø 6	Ø 150	25-95	0.8
3907	Ø 8	Ø 200	25-95	1.0
3908	Ø 10	Ø 250	25-95	1.1
3909-TB	Ø 12	Ø 300	25-95	1.5

- Copper alloy clamp with zinc plated U-bolt

Standards

BS 7430

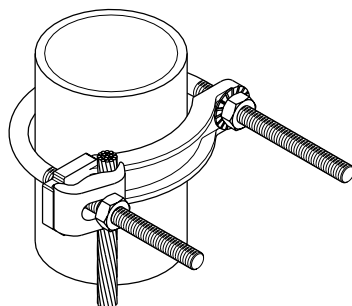

Earth bonds & clamps

Flexible braid bonds



Flexible flat copper braid bond

Part no.	Overall braid dimensions (mm)	Length (mm)	Hole diameter (A) (mm)	Cross-sectional area (mm ²)	Weight each (kg)
Copper braid					
FBB-6-200-7	12 x 1	200	Ø 7	6	0.01
FBB-6-400-7	12 x 1	400	Ø 7	6	0.02
FBB-10-200-7	15 x 1.5	200	Ø 7	10	0.02
FBB-10-400-7	15 x 1.5	400	Ø 7	10	0.04
FBB-16-200-9	19 x 2.5	200	Ø 9	16	0.03
FBB-16-400-9	19 x 2.5	400	Ø 9	16	0.06
FBB-25-200-11	25 x 3	200	Ø 11	25	0.05
FBB-25-400-11	25 x 3	400	Ø 11	25	0.10
BN505	25 x 3.5	200	Ø 11	35	0.09
BN510	25 x 3.5	400	Ø 11	35	0.15
FBB-50-200-11	30 x 5	200	Ø 11	50	0.10
FBB-50-400-11	30 x 5	400	Ø 11	50	0.20
FBB-70-200-13	32 x 6	200	Ø 13	70	0.13
FBB-70-400-13	32 x 6	400	Ø 13	70	0.25
FBB-95-200-13	37 x 6	200	Ø 13	95	0.19
FBB-95-400-13	37 x 6	400	Ø 13	95	0.37
FBB-120-200-17	45 x 6	200	Ø 17	120	0.23
FBB-120-400-17	45 x 6	400	Ø 17	120	0.46
FBB-150-200-17	50 x 8	200	Ø 17	150	0.30
FBB-150-400-17	50 x 8	400	Ø 17	150	0.60
Tinned copper braid					
FBB-6-200-7-T	12 x 1	200	Ø 7	6	0.01
FBB-6-400-7-T	12 x 1	400	Ø 7	6	0.02
FBB-10-200-7-T	15 x 1.5	200	Ø 7	10	0.02
FBB-10-400-7-T	15 x 1.5	400	Ø 7	10	0.04
FBB-16-200-9-T	19 x 2.5	200	Ø 9	16	0.03
FBB-16-400-9-T	19 x 2.5	400	Ø 9	16	0.06
FBB-25-200-11-T	25 x 3	200	Ø 11	25	0.05
FBB-25-400-11-T	25 x 3	400	Ø 11	25	0.10
BN505-T	25 x 3.5	200	Ø 11	35	0.09
BN510-T	25 x 3.5	400	Ø 11	35	0.15
FBB-50-200-11-T	30 x 5	200	Ø 11	50	0.10
FBB-50-400-11-T	30 x 5	400	Ø 11	50	0.20
FBB-70-200-13-T	32 x 6	200	Ø 13	70	0.13
FBB-70-400-13-T	32 x 6	400	Ø 13	70	0.25
FBB-95-200-13-T	37 x 6	200	Ø 13	95	0.19
FBB-95-400-13-T	37 x 6	400	Ø 13	95	0.37
FBB-120-200-17-T	45 x 6	200	Ø 17	120	0.23
FBB-120-400-17-T	45 x 6	400	Ø 17	120	0.46
FBB-150-200-17-T	50 x 8	200	Ø 17	150	0.30
FBB-150-400-17-T	50 x 8	400	Ø 17	150	0.60

- Flexible copper or flexible tinned copper braid terminated with pressed ferrule connector at each end, suitable for bonding gates, doors, fences etc. Pressed ferrule connection ensures maximum electrical contact with minimum earth resistance
- Standard braid sizes are shown. Braids are available in other sizes, lengths, materials or terminations to special order

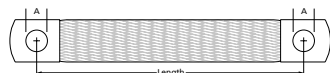

Standards

BS EN 13602
BS 7430

Earth bonds & clamps

Flexible braid bonds



Standards

BS EN 13602
BS 7430

Flexible circular copper braid bond

Part no.	Overall braid dimensions (mm)	Length (mm)	Hole diameter (A) (mm)	Cross-sectional area (mm ²)	Weight each (kg)
Copper braid					
CBB-6-200-7	4.2	200	Ø 7	6	0.01
CBB-6-400-7	4.2	400	Ø 7	6	0.02
CBB-10-200-7	5.4	200	Ø 7	10	0.02
CBB-10-400-7	5.4	400	Ø 7	10	0.04
CBB-16-200-9	7	200	Ø 9	16	0.03
CBB-16-400-9	7	400	Ø 9	16	0.06
CBB-25-200-11	8.5	200	Ø 11	25	0.05
CBB-25-400-11	8.5	400	Ø 11	25	0.10
CBB-50-200-11	11.5	200	Ø 11	50	0.10
CBB-50-400-11	11.5	400	Ø 11	50	0.20
CBB-70-200-13	14.5	200	Ø 13	70	0.13
CBB-70-400-13	14.5	400	Ø 13	70	0.25
CBB-95-200-13	16	200	Ø 13	95	0.19
CBB-95-400-13	16	400	Ø 13	95	0.37
Tinned copper braid					
CBB-6-200-7-T	4.2	200	Ø 7	6	0.01
CBB-6-400-7-T	4.2	400	Ø 7	6	0.02
CBB-10-200-7-T	5.4	200	Ø 7	10	0.02
CBB-10-400-7-T	5.4	400	Ø 7	10	0.04
CBB-16-200-9-T	7	200	Ø 9	16	0.03
CBB-16-400-9-T	7	400	Ø 9	16	0.06
CBB-25-200-11-T	8.5	200	Ø 11	25	0.05
CBB-25-400-11-T	8.5	400	Ø 11	25	0.10
CBB-50-200-11-T	11.5	200	Ø 11	50	0.10
CBB-50-400-11-T	11.5	400	Ø 11	50	0.20
CBB-70-200-13-T	14.5	200	Ø 13	70	0.13
CBB-70-400-13-T	14.5	400	Ø 13	70	0.25
CBB-95-200-13-T	16	200	Ø 13	95	0.19
CBB-95-400-13-T	16	400	Ø 13	95	0.37

- Flexible copper or flexible tinned copper braid terminated with pressed terminal lug at each end, suitable for bonding gates, doors, fences etc. Pressed terminal lug connection ensures maximum electrical contact with minimum earth resistance
- Standard braid sizes are shown. Braids are available in other sizes, lengths, materials or terminations to special order

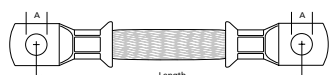

Earth bonds & clamps

Static earth connection points



Eyebolt

Part no.	Nominal copperbond rod diameter (")	Weight each (kg)
BT150	3/8	0.52
BT160	1/2	0.52

– Screws direct onto a copperbond earth rod, offering an earth point for boats, trucks etc.

Standards

BS 7430

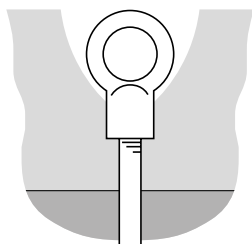

8



Static earth receptacle

Part no.	Conductor material	Weight each (kg)
RX005	Copper	0.64

– For setting into roadways or runways. Provides a static discharge point for aircraft, fuel tankers, etc.

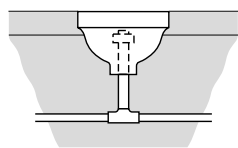

Standards

BS 7430

Earth bonds & clamps

Static earth clamps



Stainless steel earthing clamp

Part no.	Description	Jaw opening (mm)	Cable length (max) (m)	Weight each (kg)
SK010	Medium duty earthing clamp	15	3	0.56
SK020	Heavy duty earthing clamp	35	5	1.09

Clamp Certification Ex ii 1 GD T6. Heavy duty earthing clamp FM Approved

- Medium duty stainless earthing clamp for earthing buckets, small drums, containers and plant equipment etc.
- Heavy duty stainless earthing clamp for earthing 205 litre drums, IBCs, production vessels and road tankers etc.
- Clamp features twin tungsten carbide teeth for effective penetration of paint and contamination
- Supplied complete with chemically resistant Cen-Stat Spiral Cable and 10 mm ring terminal

Standards



ii 1 GD T6



APPROVED



Stainless steel earthing clamp & reel

Part no.	Description	Jaw opening (mm)	Cable length (max) (m)	Weight each (kg)
SK030	Medium duty earthing clamp & reel	15	6.1	3
SK040	Heavy duty earthing clamp & reel	35	15.2	6

Clamp Certification Ex ii 1 GD T6. Reel Certification Ex ii 2 GD T6. Heavy duty earthing clamp FM Approved

- Medium duty stainless earthing clamp for earthing buckets, small drums, containers and plant equipment etc.
- Heavy duty stainless earthing clamp for earthing 205 litre drums, IBC's, production vessels and road tankers
- Clamp features twin tungsten carbide teeth for effective penetration of paint and contamination
- Supplied complete with retracting cable reel

Standards



ii 1 GD T6



APPROVED

Earth bonds & clamps

Earth bars



Copper Earth Bar



Tinned copper Earth Bar

Furse earth bars are an efficient and convenient way of providing a common earth point, and integral disconnecting links allow easy isolation for testing purposes.

- Swan-Neck accessory, to facilitate the main earth bar connection
- Available as bare copper or tinned copper hard drawn bar

8

Standard Furse earth bars are available in a variety of lengths, but all consist of a 50 mm wide by 6 mm thick copper bar with M10 termination screws - standard product codes are provided.

Standard features and benefits

- The plastic channel base is entirely corrosion proof, made from high impact uPVC unlike the traditional galvanized steel channel
- Lighter and easier to handle, the use of a modern polymer channel has reduced the weight of the products, making them easier to handle
- Pre-drilled fixing holes for ease of installation
- A range of three designs to meet most installation requirements

Special earth bar requirements

Standard earth bars meet the majority of applications, however where a customer has a specific requirement, we can design and manufacture special earth bars and disconnecting links as appropriate. Special earth bar designs are provided for customer review and approval as required before manufacture.

Special earth bar design variables include:

- Size and type of bolt, hex nut and washer
- Length, width and thickness of earth bar
- Number of disconnecting links, and their position
- Number of insulators
- Supplied with mounting base or without

An example of a customer special earth bar comprising M10 and M6 studs and disconnecting links

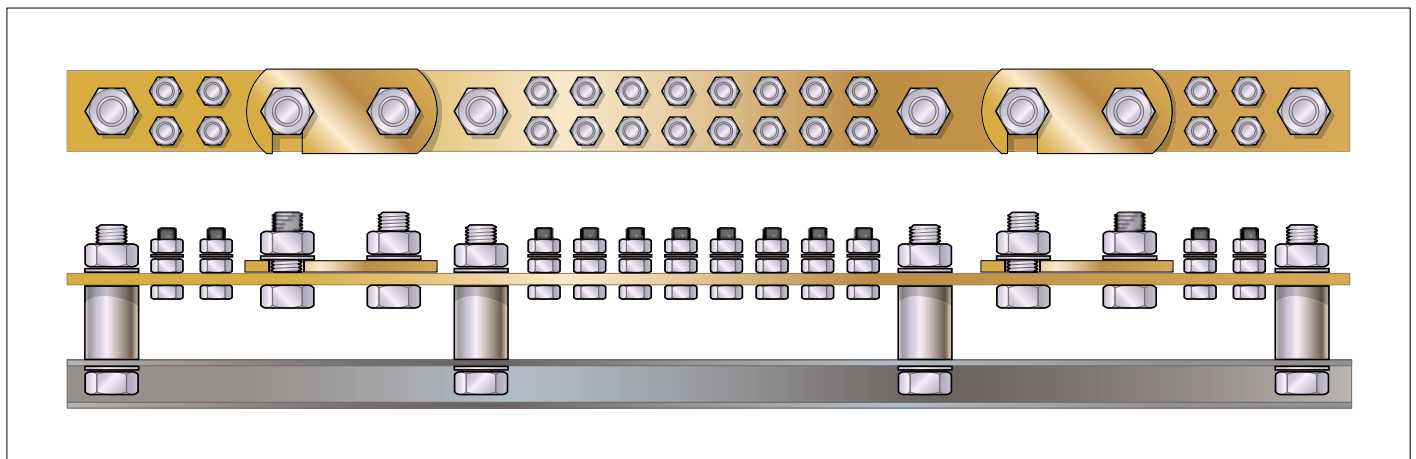

Earth bonds & clamps

Earth bars

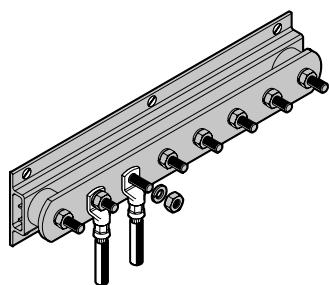

Standards

BS 7430

Earth bar

Part no.	Description	Length (mm)	Weight each (kg)
Copper earth bar			
LK245-6	6 way	400	1.80
LK245-8	8 way	500	2.20
LK245-10	10 way	650	2.80
LK245-12	12 way	750	3.20
LK245-14	14 way	850	3.60
LK245-16	16 way	950	4.00
LK245-18	18 way	1050	4.40
LK245-20	20 way	1200	5.00
LK245-22	22 way	1300	5.40
LK245-24	24 way	1400	5.80
LK245-26	26 way	1500	6.20
LK245-28	28 way	1650	6.90
LK245-30	30 way	1750	7.30
Tinned copper earth bar			
LK245-6-T	6 way	400	1.80
LK245-8-T	8 way	500	2.20
LK245-10-T	10 way	650	2.80
LK245-12-T	12 way	750	3.20
LK245-14-T	14 way	850	3.60
LK245-16-T	16 way	950	4.00
LK245-18-T	18 way	1050	4.40
LK245-20-T	20 way	1200	5.00
LK245-22-T	22 way	1300	5.40
LK245-24-T	24 way	1400	5.80
LK245-26-T	26 way	1500	6.20
LK245-28-T	28 way	1650	6.90
LK245-30-T	30 way	1750	7.30

– Fix using countersunk wood screws 1½" No. 12 (Part no. SW110) and wall plugs (Part no. PS310)

– Standard width x height: 90 mm x 77 mm

Earth bonds & clamps

Earth bars

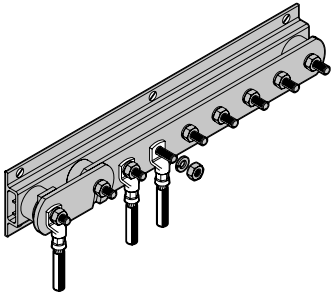

Earth bar with single disconnecting link

Part no.	Description	Length (mm)	Weight each (kg)
Copper earth bar			
LK243-6	6 way	475	2.30
LK243-8	8 way	575	2.70
LK243-10	10 way	725	3.30
LK243-12	12 way	825	3.70
LK243-14	14 way	925	4.10
LK243-16	16 way	1025	4.50
LK243-18	18 way	1125	4.90
LK243-20	20 way	1275	5.50
LK243-22	22 way	1375	5.90
LK243-24	24 way	1475	6.30
LK243-26	26 way	1575	6.70
LK243-28	28 way	1725	7.40
LK243-30	30 way	1825	7.80
Tinned copper earth bar			
LK243-6-T	6 way	475	2.30
LK243-8-T	8 way	575	2.70
LK243-10-T	10 way	725	3.30
LK243-12-T	12 way	825	3.70
LK243-14-T	14 way	925	4.10
LK243-16-T	16 way	1025	4.50
LK243-18-T	18 way	1125	4.90
LK243-20-T	20 way	1275	5.50
LK243-22-T	22 way	1375	5.90
LK243-24-T	24 way	1475	6.30
LK243-26-T	26 way	1575	6.70
LK243-28-T	28 way	1725	7.40
LK243-30-T	30 way	1825	7.80

- Fix using countersunk wood screws 1½" No. 12 (Part no. SW110) and wall plugs (Part no. PS310)
- Standard width x height: 90 mm x 77 mm

Standards

BS 7430

Earth bonds & clamps

Earth bars

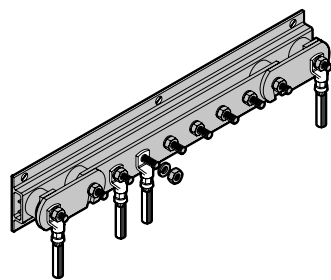

Earth bar with twin disconnecting link

Part no.	Description	Length (mm)	Weight each (kg)
Copper earth bar			
LK207-6	6 way	550	2.80
LK207-8	8 way	650	3.20
LK207-10	10 way	800	3.80
LK207-12	12 way	900	4.20
LK207-14	14 way	1000	4.60
LK207-16	16 way	1100	5.00
LK207-18	18 way	1200	5.40
LK207-20	20 way	1350	6.00
LK207-22	22 way	1450	6.40
LK207-24	24 way	1550	6.80
LK207-26	26 way	1650	7.20
LK207-28	28 way	1800	7.90
LK207-30	30 way	1900	8.30
Tinned copper earth bar			
LK207-6-T	6 way	550	2.80
LK207-8-T	8 way	650	3.20
LK207-10-T	10 way	800	3.80
LK207-12-T	12 way	900	4.20
LK207-14-T	14 way	1000	4.60
LK207-16-T	16 way	1100	5.00
LK207-18-T	18 way	1200	5.40
LK207-20-T	20 way	1350	6.00
LK207-22-T	22 way	1450	6.40
LK207-24-T	24 way	1550	6.80
LK207-26-T	26 way	1650	7.20
LK207-28-T	28 way	1800	7.90
LK207-30-T	30 way	1900	8.30

Standards

BS 7430

- Fix using countersunk wood screws 1½" No. 12 (Part no. SW110) and wall plugs (Part no. PS310)
- Standard width x height: 90 mm x 77 mm

Earth bonds & clamps

Accessories

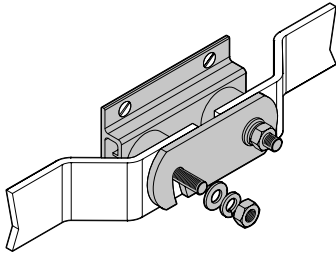

Earth bar accessories

Part no.	Description	Length (mm)	Width (mm)	Height (mm)	Weight each (kg)
Copper earth bar					
LK004	Swan-neck link	400	50	36	0.42
LK205	Disconnecting link	125	90	77	0.59
Tinned copper earth bar					
LK004-T	Swan-neck link	400	50	36	0.42
LK205-T	Disconnecting link	125	90	77	0.59

Standards

BS 7430

– Fix using countersunk wood screws 1½" No. 12 (Part no. SW110) and wall plugs (Part no. PS310) fixings only apply to disconnecting link



Insulator

Part no.	Height (A) (mm)	Top diameter (B) (mm)	Max diameter (C) (mm)	Insert size	For copper bar size (mm)
Insulator					
IN020	20	Ø 14	Ø 18	M6	25 x 3
IN030	30	Ø 25	Ø 33	M6	25 x 6
IN040	40	Ø 31	Ø 39	M8	38 x 6
IN013	50	Ø 27	Ø 35	M10	50 x 6
IN060	60	Ø 38	Ø 52	M10	75 x 6
IN070	70	Ø 51	Ø 55	M12	100 x 6
Insulator with 2 studs and 3 nuts					
IN005	50	Ø 27	Ø 35	M10	50 x 6

– Insulator manufactured from grey GRP material with brass insert

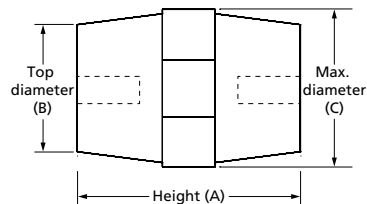
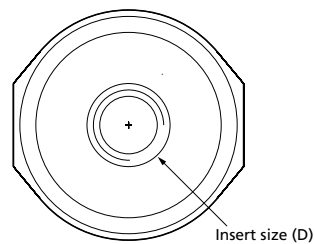

Earth bonds & clamps

Compression connectors



'C' shape connector

Part no.	Conductor range (main) (mm ²)	Conductor range (tap) (mm ²)	Box quantity	Weight each (kg)
Copper 'C' shape connector				
CN1010	10	1.5-10	100	0.01
CN1616	16	1.5-16	100	0.02
CN2510	16-25	1.5-10	50	0.02
CN2525	25	16-25	50	0.02
CN3516	35	1.5-16	25	0.04
CN3535	35	25-35	25	0.04
CN5025	50	4-25	25	0.09
CN5050	50	35-50	25	0.09
CN7025	70	1.5-25	25	0.04
CN7035	50-70	4-35	25	0.10
CN7070	50-70	35-70	25	0.09
CN9535	95	4-35	25	0.15
CN9570	95	35-70	25	0.15
CN9595	95	70-95	25	0.14
CN120120	120	25-120	25	0.17
CN150120	150	25-120	25	0.16
CN150150	150	70-150	25	0.12
CN18595	185	16-95	25	0.13
CN185185	120-185	120-185	15	0.23
CN240120	150-240	95-120	15	0.24
CN240150	240-150	240-150	10	0.25
CN240185	240-185	240-185	10	0.25
CN240240	240-240	240-240	10	0.27
CN300120	300-120	300-120	10	0.30
CN300300	300-300	300-300	10	0.28

- Manufactured from pure copper
- Ensure all underground connections are sealed/waterproofed using Denso Tape
- Additional sizes available on request

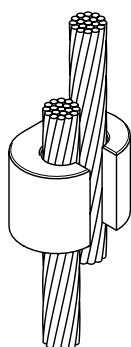

Earth bonds & clamps

Compression connectors



'C' shape connector

Part no.	Conductor range (main) (mm ²)	Conductor range (tap) (mm ²)	Box quantity	Weight each (kg)
Tinned copper 'C' shape connector				
CN1010-T	10	1.5-10	100	0.01
CN1616-T	16	1.5-16	100	0.02
CN2510-T	16-25	1.5-10	50	0.02
CN2525-T	25	16-25	50	0.02
CN3516-T	35	1.5-16	25	0.04
CN3535-T	35	25-35	25	0.04
CN5025-T	50	4-25	25	0.09
CN5050-T	50	35-50	25	0.09
CN7025-T	70	1.5-25	25	0.04
CN7035-T	50-70	4-35	25	0.10
CN7070-T	50-70	35-70	25	0.09
CN9535-T	95	4-35	25	0.15
CN9570-T	95	35-70	25	0.15
CN9595-T	95	70-95	25	0.14
CN120120-T	120	25-120	25	0.17
CN150120-T	150	25-120	25	0.16
CN150150-T	150	70-150	25	0.12
CN18595-T	185	16-95	25	0.13
CN185185-T	120-185	120-185	15	0.23
CN240120-T	150-240	95-120	15	0.24
CN240150-T	240-150	240-150	10	0.25
CN240185-T	240-185	240-185	10	0.25
CN240240-T	240-240	240-240	10	0.27
CN300120-T	300-120	300-120	10	0.30
CN300300-T	300-300	300-300	10	0.28

- Manufactured from electroplated tinned pure copper
- Ensure all underground connections are sealed/waterproofed using Denso Tape
- Additional sizes available on request

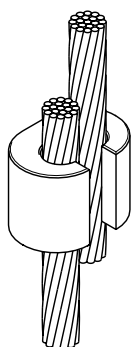

Earth bonds & clamps

Tinned copper cable lugs

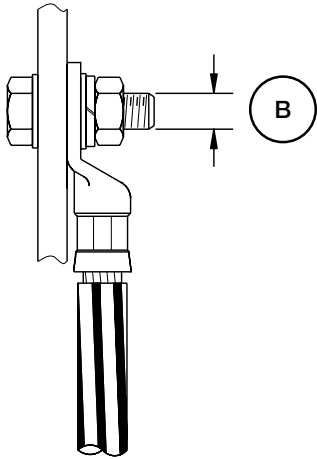

Tinned copper cable lug

Part no.	Conductor size (mm ²)	Screw size (B) (mm)	Weight each (kg)
FCT166	16	6	0.01
FCT168	16	8	0.01
FCT1610	16	10	0.01
FCT1612	16	12	0.01
FCT256	25	6	0.01
FCT258	25	8	0.01
FCT2510	25	10	0.01
FCT2512	25	12	0.01
FCT356	35	6	0.01
FCT358	35	8	0.01
FCT3510	35	10	0.01
FCT3512	35	12	0.01
FCT506	50	6	0.02
FCT508	50	8	0.02
FCT5010	50	10	0.02
FCT5012	50	12	0.02
FCT708	70	8	0.04
FCT7010	70	10	0.04
FCT7012	70	12	0.04
FCT7014	70	14	0.04
FCT7016	70	16	0.04
FCT958	95	8	0.06
FCT9510	95	10	0.06
FCT9512	95	12	0.06
FCT9514	95	14	0.06
FCT9516	95	16	0.06
FCT12010	120	10	0.06
FCT12012	120	12	0.06
FCT12014	120	14	0.06
FCT12016	120	16	0.06
FCT15010	150	10	0.09
FCT15012	150	12	0.09
FCT15014	150	14	0.09
FCT15016	150	16	0.09
FCT18512	185	12	0.11
FCT18514	185	14	0.11
FCT18516	185	16	0.11
FCT24012	240	12	0.14
FCT24014	240	14	0.14
FCT24016	240	16	0.14
FCT30012	300	12	0.17
FCT30014	300	14	0.17
FCT30016	300	16	0.17
FCT40012	400	12	0.21
FCT40014	400	14	0.21
FCT40016	400	16	0.21

Standards

BS EN 12449
BS EN 1872
BS EN 4579

– Use with tool HT010

Earth bonds & clamps

Compression connector dies



'C' shape connector die

Part no.	Conductor range (main) (mm ²)	Conductor range (tap) (mm ²)	Weight each (kg)
HT010 and HT040 tooling			
HD100	10	1.5-10	0.26
HD200	16	1.5-16	0.26
HD200	16-25	1.5-10	0.26
HD200	25	16-25	0.26
HD300	35	1.5-16	0.28
HD300	35	25-35	0.28
HD300	70	1.5-25	0.28
HD400	50	4-25	0.27
HD400	50	35-50	0.27
HD400	50-70	4-35	0.27
HD400	50-70	35-70	0.27
HD500	95	4-35	0.27
HD500	95	35-70	0.27
HD500	95	70-95	0.27
HD600	120	25-120	0.27
HD600	150	25-120	0.27
HD600	150	70-150	0.27
HD600	185	16-95	0.27
HD800	240	95-120	0.28
HT020 and HT030 tooling			
HD700	120-185	120-185	0.22
HD700	150-240	95-120	0.22

– Manufactured from high quality stainless steel

Earth bonds & clamps

Compression tools



Hydraulic crimping tool

Part no.	Description	Weight each (kg)
HT010	Hand operated 13 ton tool with carrying case	8

- Self-contained hydraulic crimping tool used for jointing and terminating copper, aluminium and ACSR conductors
- Crimping force 130 kN
- Two stage 'rapid-ram' advance mechanism for fast installation
- Short fibreglass handle for combined work spaces
- Accepts most U-Type dies of equivalent tonnage
- 180° head rotation
- Includes carrying case
- Dies are not included



Hydraulic crimping head and pump

Part no.	Description	Weight each (kg)
HT020	15 ton hydraulic tool with carrying case	5.5
HT030	Foot operated hydraulic pump with carrying case	16.5

- Self-contained hydraulic crimping tool used for jointing and terminating copper, aluminium and ACSR conductors
- Crimping force 230 kN, maximum operating pressure 700 Bar
- Hydraulic head complete with quick automatic coupler for connection to pump
- Accepts most U-Type dies of equivalent tonnage
- Pump supplied with 3 m long high pressure flexible hose
- Each supplied with carrying case
- Dies are not included

Earth bonds & clamps

Compression tools



Battery powered hydraulic crimping tool

Part no.	Description	Weight each (kg)
HT040	Battery powered, open head 14 ton tool	10.6

- This self-contained, compact, cordless hydraulic tool makes crimping easy with its lightweight single handed design
- Crimping force 130 kN
- Two stage 'rapid-ram' advance mechanism for fast installation
- Accepts most U-Type dies of equivalent tonnage
- 180° head rotation
- Dies are not included
- The tool is supplied with:
 - Basic tool complete with battery
 - Shoulder strap
 - Spare battery (14.4 V 3.0 Ah)
 - Battery charger
 - Carrying case suitable for storing up to 14 sets of dies

8



Battery powered hydraulic cutting tool

Part no.	Description	Weight each (kg)
HT050	Battery powered 6 ton cutting tool	6.5

- This self-contained, compact, cordless hydraulic tool makes cutting copper, aluminium, ACSR and steel earth rods easy with its lightweight single handed design
- Two stage 'rapid-ram' advance mechanism for fast installation
- Maximum cutting diameter of 25 mm
- Blades manufactured from high strength special steel, heat treated to ensure a long service life
- 180° head rotation
- The tool is supplied with:
 - Basic tool complete with battery
 - Battery wrist strap and shoulder strap
 - Spare battery (14.4 V 3.0 Ah)
 - Battery charger
 - Carrying case suitable for storing tool and accessories



FurseWELD

Introduction	9/2
Connection selection guide	9/6

Bar to bar

Bar to bar BB1	9/8
Bar to bar BB3	9/9
Bar to bar BB7	9/10
Bar to bar BB14	9/11
Bar to bar BB41	9/12

Bar to steel surface

Bar to steel surface BS1	9/13
Bar to steel surface BS2	9/14
Bar to steel surface BS3	9/15

Bar to earth rod

Bar to earth rod BR1	9/16
Bar to earth rod BR2	9/18
Bar to earth rod BR7	9/20

Cable to bar

Cable to bar CB1	9/22
Cable to bar CB4	9/23
Cable to bar CB5	9/24

Bar to cable

Cable to cable CC1	9/25
Cable to cable CC2	9/26
Cable to cable CC4	9/27
Cable to cable CC6	9/28
Cable to cable CC7	9/29
Cable to cable CC11	9/30
Cable to cable CC14	9/31
Cable to earth rod CR1	9/32
Cable to earth rod CR2	9/33
Cable to earth rod CR3	9/34
Cable to earth rod CR17	9/35
Cable to earth rod CR24	9/36

Cable to reinforcing bar

Cable to reinforcing bar CRE1	9/37
Cable to reinforcing bar CRE2	9/38
Cable to reinforcing bar CRE3	9/39
Cable to reinforcing bar CRE6	9/40
Cable to reinforcing bar CRE17	9/40

Cable to steel surfacing & pipe

Cable to steel surface & pipe CS1	9/41
Cable to steel surface & pipe CS2	9/41
Cable to steel surface & pipe CS3	9/42
Cable to steel surface & pipe CS7	9/42
Cable to steel surface & pipe CS8	9/43
Cable to steel surface & pipe CS9	9/43
Cable to steel surface & pipe CS25	9/44
Cable to steel surface & pipe CS27	9/44
Cable to steel surface & pipe CS32	9/45
Cable to steel surface & pipe CS34	9/46

Stud to steel surface

Stud to steel surface RS1	9/47
Stud to steel surface RS2	9/47

SureSHOT

Introduction	9/48
SureSHOT SS1	9/49
SureSHOT SS2	9/49

Straight type lug & cranked type lug

Straight type lug	9/50
Cranked type lug	9/50

Offset type lug

Offset type lug	9/51
-----------------	------

Handle clamps

Handle clamps	9/52
---------------	------

Accessories

Cable cleaning brush	9/53
Mould cleaning brush	9/53
Tape cleaning brush	9/53
Duxseal sealing compound	9/53
Flint gun	9/53
Replacement flints	9/53
Hammer die	9/53
Packing	9/53
Copper sleeve	9/53
Mould cleaning scraper	9/53
Welding toolbox	9/53
Standard toolkit for bar to bar joints	9/53
Standard toolkit for cable to cable joints	9/53
Mould jacket	9/53

FurseWELD

Introduction



9

FurseWELD exothermic welding is a cost efficient method of making large or small numbers of high quality electrical connections.

The FurseWELD process

FurseWELD is a simple, self-contained system that uses the high temperature reaction of powdered copper oxide and aluminium, within a mould, to form permanent electrical connections.

Typical applications include:

- Earthing for power plants and substations
- Telecommunications
- Transmission and power distribution lines
- Cathodic protection
- Rail connections

The FurseWELD system:

- Requires no external power or heat source
- Creates high quality electrical connections
- Completely portable
- Can be used safely with minimum training
- Cost effective
- Can be used for over 45 connection configurations

The FurseWELD connection

FurseWELD connections have several advantages:

- Tolerant to repeated fault currents
- Highly conductive
- Does not loosen
- Excellent corrosion resistance

Most FurseWELD connections have at least twice the cross-sectional area of the conductors being joined, and an equivalent or greater current carrying capacity. Corrosion resistance is exceptional because of the very high copper content (> 90%) of the alloy.



FurseWELD

Introduction

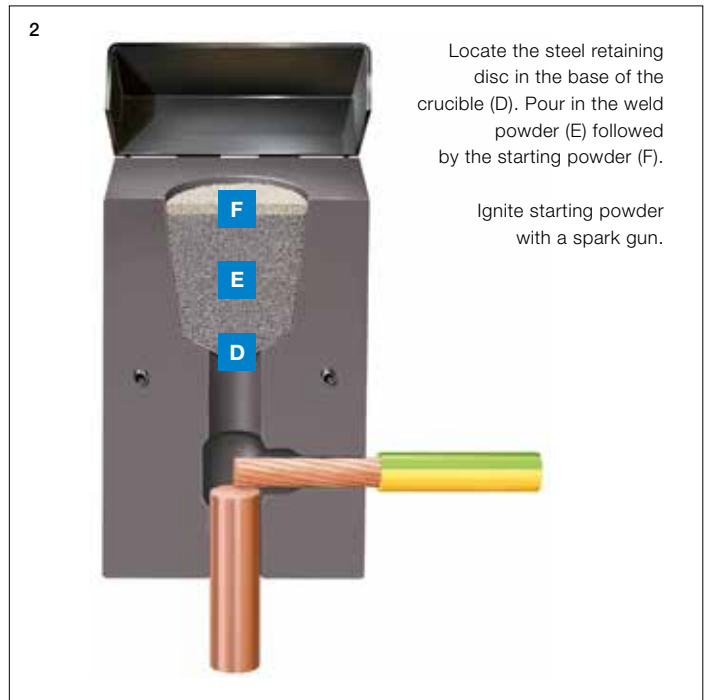
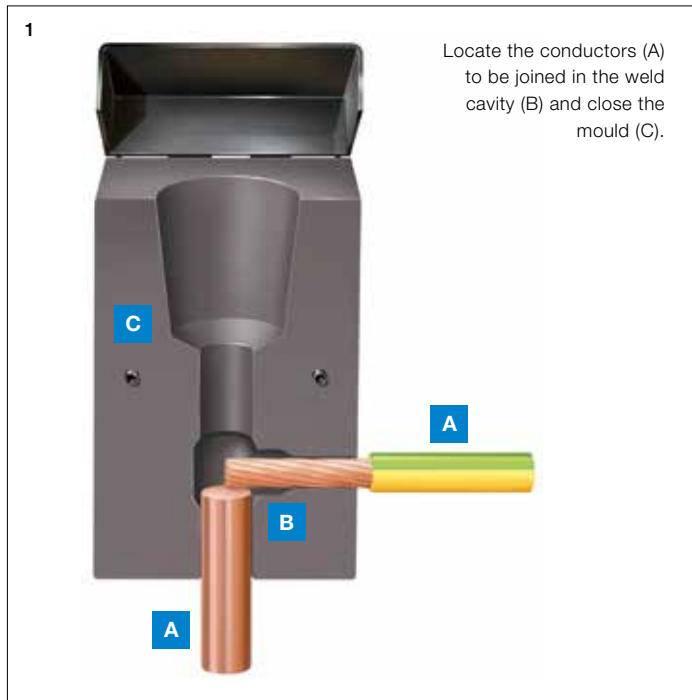

Making a FurseWELD joint is a simple procedure

9

Moulds

The FurseWELD system of exothermic welding uses moulds to contain the exothermic reaction that creates safe and robust connections. Different types of moulds are available, whose use depends on the requirements of the project.

Full-sized graphite moulds

Market leading FurseWELD graphite moulds are extremely robust and capable of producing up to 75 connections each, if not more when properly maintained.

Mini-Moulds

FurseWELD mini-moulds are a cost effective alternative to full-sized moulds, especially where lower numbers of connections are required. They are smaller overall, less robust and therefore lower priced. Care is required in order to achieve similar service lives to full-sized moulds.

FurseWELD products

- A powder cartridge is required for each joint to be made
- Handle clamps enable the mould to be handled when hot, and the two halves of the mould to be opened and clamped together
- Packing is required when welding to reinforcing bar

Conductors

The range of FurseWELD moulds is designed to work with all common conductor formats.

- Flat tape conductor
- Stranded conductor
- Solid circular conductor

Conductors must be in the orientation shown to achieve the correct connection. Furse offers technical support to assist with selection of joint type. Please contact us where unsure, e.g. where you may be using compacted stranded conductor.

If connections shown do not meet your requirements, please contact your local sales office.

3

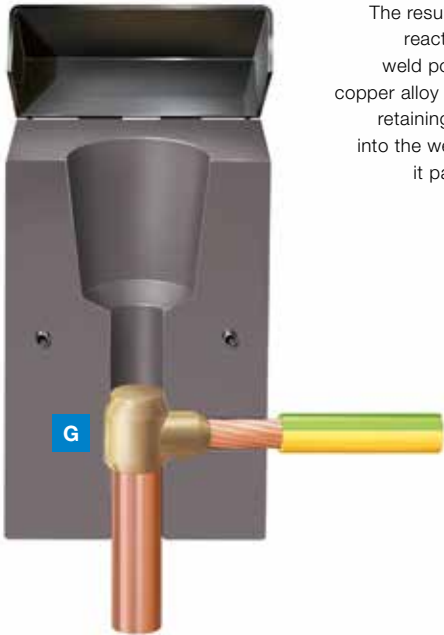

The resulting exothermic reaction reduces the weld powder to molten copper alloy which melts the retaining disc and flows into the weld cavity where it partially melts the conductors (G).

4

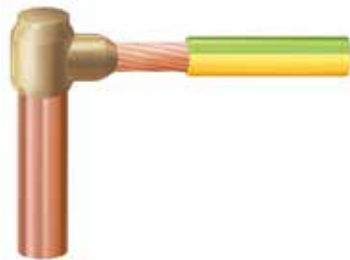

The molten copper alloy cools to leave a fusion weld of great mechanical and electrical integrity.

SureSHOT

The FurseWELD SureSHOT system is a single-use ceramic mould supplied complete with retaining disc and powders. It has been designed for use in applications where only a few connections are required.



FurseWELD

Connection selection guide

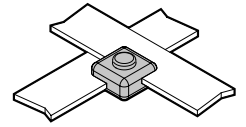
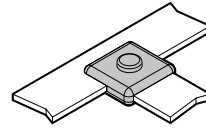
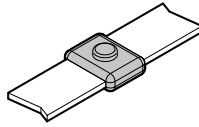
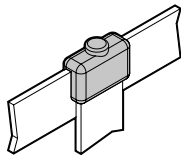
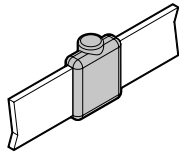

Bar to bar

Connection Type	Type BB1	Type BB3	Type BB7	Type BB14	Type BB41
Section 9 / Page No.	9/8	9/9	9/10	9/11	9/12

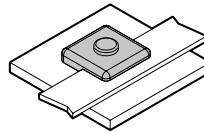
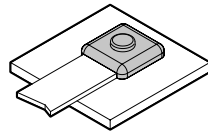
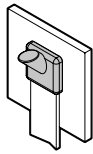

Bar to steel surface

Connection Type	Type BS1	Type BS2	Type BS3
Section 9 / Page No.	9/13	9/14	9/15

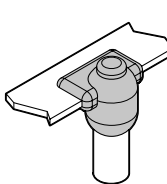
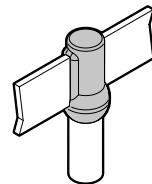
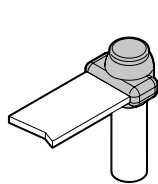

Bar to earth rod

Connection Type	Type BR1	Type BR2	Type BR7
Section 9 / Page No.	9/16	9/18	9/20

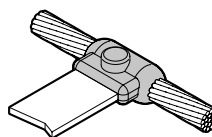
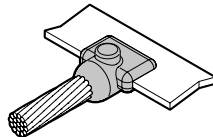
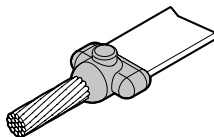

Cable to bar

Connection Type	Type CB1	Type CB4	Type CB5
Section 9 / Page No.	9/22	9/23	9/24

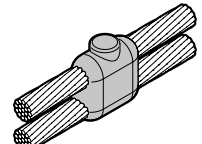
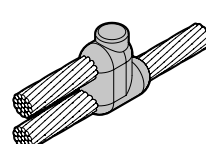
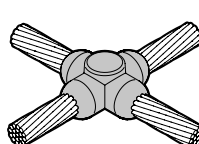
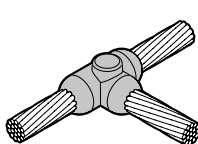
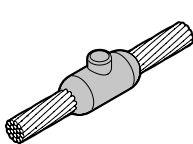

Cable to cable

Connection Type	Type CC1	Type CC2	Type CC4	Type CC6	Type CC7
Section 9 / Page No.	9/25	9/26	9/27	9/28	9/29

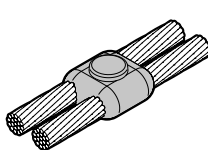
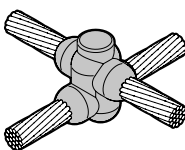

Connection Type	Type CC11	Type CC14
Section 9 / Page No.	9/30	9/31

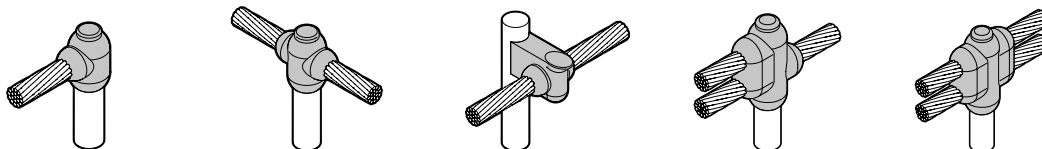

Cable to earth rod

Connection Type	Type CR1	Type CR2	Type CR3	Type CR17	Type CR24
Section 9 / Page No.	9/32	9/33	9/34	9/35	9/36

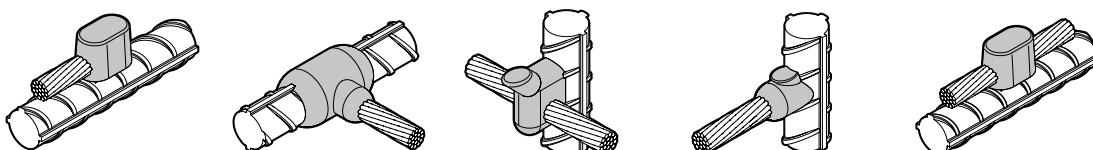

Cable to reinforcing bar

Connection Type	Type CRE1	Type CRE2	Type CRE3	Type CRE6	Type CRE17
Section 9 / Page No.	9/37	9/38	9/39	9/40	9/40

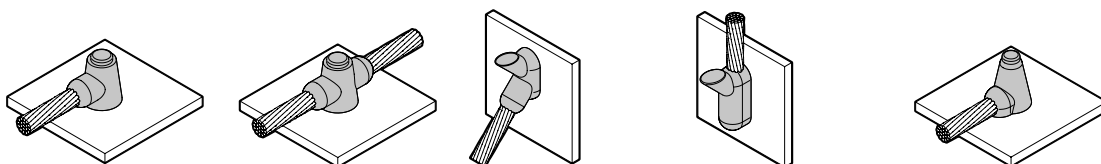

Cable to steel surface & pipe

Connection Type	Type CS1	Type CS2	Type CS3	Type CS7	Type CS8
Section 9 / Page No.	9/41	9/41	9/42	9/42	9/43

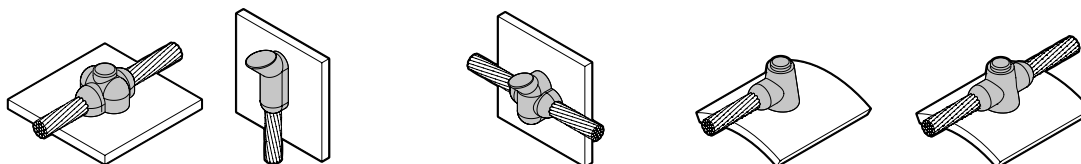

Connection Type	Type CS9	Type CS25	Type CS27	Type CS32	Type CS34
Section 9 / Page No.	9/43	9/44	9/44	9/45	9/46



Stud to steel surface

Connection Type	Type RS1	Type RS2
Section 9 / Page No.	9/47	9/47

SureSHOT

Connection Type	Type SS1	Type SS2
Section 9 / Page No.	9/49	9/49

Conductors must be in the orientation shown to achieve the correct connection

Furse offers technical support to assist with selection of joint type. If connections shown do not meet your requirements, please contact your local sales office on +44 (0)115 964 3700 (UK), +971 (0)4 609 1635 (Dubai) or +65 6776 5711 (Singapore) for assistance.

FurseWELD

Bar to bar BB1

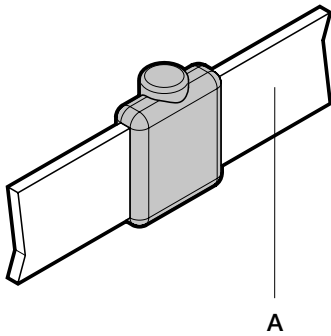

Bar to bar BB1 - FurseWELD

Flat tape conductor size A (mm)	Part no.				
	Powder cartridge	Standard mould	Handle clamp	Mini mould	Mini handle clamp
20 x 3	45P10	BB1-4-203	HCPK4	BB1-3-203	HCPK3
25 x 3	65P10	BB1-4-253	HCPK4	BB1-3-253	HCPK3
25 x 4	90P10	BB1-4-254	HCPK4	BB1-3-254	HCPK3
25 x 6	150P10	BB1-4-256	HCPK4	-	-
30 x 2	65P10	BB1-4-302	HCPK4	BB1-3-302	HCPK3
30 x 3	90P10	BB1-4-303	HCPK4	BB1-3-303	HCPK3
30 x 4	115P10	BB1-4-304	HCPK4	BB1-3-304	HCPK3
30 x 5	115P10	BB1-4-305	HCPK4	BB1-3-305	HCPK3
31 x 3	90P10	BB1-4-313	HCPK4	BB1-3-313	HCPK3
31 x 6	150P10	BB1-4-316	HCPK4	-	-
38 x 3	115P10	BB1-4-383	HCPK4	-	-
38 x 5	150P10	BB1-4-385	HCPK4	-	-
38 x 6	200P10	BB1-4-386	HCPK4	-	-
40 x 3	115P10	BB1-4-403	HCPK4	-	-
40 x 4	150P10	BB1-4-404	HCPK4	-	-
40 x 5	150P10	BB1-4-405	HCPK4	-	-
40 x 6	200P10	BB1-4-406	HCPK4	-	-
50 x 3	150P10	BB1-4-503	HCPK4	-	-
50 x 4	200P10	BB1-4-504	HCPK4	-	-
50 x 5	200P10	BB1-4-505	HCPK4	-	-
50 x 6	250P10	BB1-4-506	HCPK4	-	-

Special moulds for all FurseWELD products can be manufactured to meet specific customer applications on request

FurseWELD

Bar to bar BB3

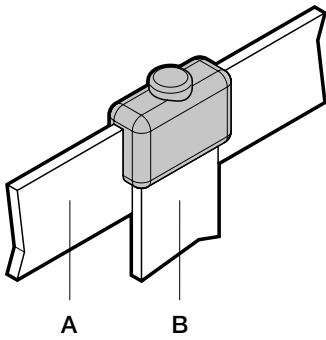

Bar to bar BB3 - FurseWELD

Flat tape conductor size A (mm)	Flat tape conductor size B (mm)	Part no.				
		Powder cartridge	Standard mould	Handle clamp	Mini mould	Mini handle clamp
20 x 3	20 x 3	65P10	BB3-4-203203	HCPK4	BB3-3-203203	HCPK3
25 x 3	25 x 3	65P10	BB3-4-253253	HCPK4	BB3-3-253253	HCPK3
25 x 4	25 x 4	90P10	BB3-4-254254	HCPK4	BB3-3-254254	HCPK3
25 x 6	25 x 6	150P10	BB3-4-256256	HCPK4	–	–
30 x 2	30 x 2	65P10	BB3-4-302302	HCPK4	BB3-3-302302	HCPK3
30 x 3	30 x 3	90P10	BB3-4-303303	HCPK4	BB3-3-303303	HCPK3
30 x 4	30 x 4	115P10	BB3-4-304304	HCPK4	BB3-3-304304	HCPK3
30 x 5	30 x 5	115P10	BB3-4-305305	HCPK4	BB3-3-305305	HCPK3
31 x 3	31 x 3	115P10	BB3-4-313313	HCPK4	BB3-3-313313	HCPK3
31 x 6	31 x 6	200P10	BB3-4-316316	HCPK4	–	–
38 x 3	38 x 3	115P10	BB3-4-383383	HCPK4	–	–
38 x 5	38 x 5	150P10	BB3-4-385385	HCPK4	–	–
38 x 6	38 x 6	200P10	BB3-4-386386	HCPK4	–	–
40 x 3	40 x 3	115P10	BB3-4-403403	HCPK4	–	–
40 x 4	40 x 4	150P10	BB3-4-404404	HCPK4	–	–
40 x 5	40 x 5	150P10	BB3-4-405405	HCPK4	–	–
40 x 6	40 x 6	200P10	BB3-4-406406	HCPK4	–	–
50 x 3	50 x 3	200P10	BB3-4-503503	HCPK4	–	–
50 x 4	50 x 4	200P10	BB3-4-504504	HCPK4	–	–
50 x 5	50 x 5	200P10	BB3-4-505505	HCPK4	–	–
50 x 6	50 x 6	250P10	BB3-4-506506	HCPK4	–	–

Special moulds for all FurseWELD products can be manufactured to meet specific customer applications on request

FurseWELD

Bar to bar BB7

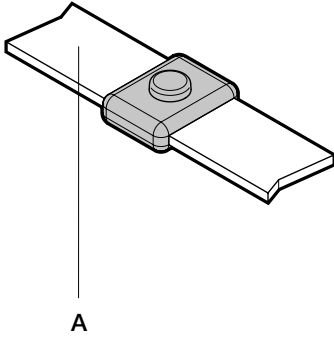

Bar to bar BB7 - FurseWELD

Flat tape conductor size A (mm)	Part no.				
	Powder cartridge	Standard mould	Handle clamp	Mini mould	Mini handle clamp
20 x 3	45P10	BB7-4-203	HCPK4	BB7-3-203	HCPK3
25 x 3	65P10	BB7-4-253	HCPK4	BB7-3-253	HCPK3
25 x 4	90P10	BB7-4-254	HCPK4	BB7-3-254	HCPK3
25 x 6	115P10	BB7-4-256	HCPK4	BB7-3-256	HCPK3
30 x 2	65P10	BB7-4-302	HCPK4	BB7-3-302	HCPK3
30 x 3	65P10	BB7-4-303	HCPK4	BB7-3-303	HCPK3
30 x 4	90P10	BB7-4-304	HCPK4	BB7-3-304	HCPK3
30 x 5	115P10	BB7-4-305	HCPK4	BB7-3-305	HCPK3
31 x 3	65P10	BB7-4-313	HCPK4	BB7-3-313	HCPK3
31 x 6	150P10	BB7-4-316	HCPK4	–	–
38 x 3	90P10	BB7-4-383	HCPK4	–	–
38 x 5	150P10	BB7-4-385	HCPK4	–	–
38 x 6	200P10	BB7-4-386	HCPK4	–	–
40 x 3	90P10	BB7-4-403	HCPK4	–	–
40 x 4	115P10	BB7-4-404	HCPK4	–	–
40 x 5	150P10	BB7-4-405	HCPK4	–	–
40 x 6	200P10	BB7-4-406	HCPK4	–	–
50 x 3	150P10	BB7-5-503	HCPK5	–	–
50 x 4	200P10	BB7-5-504	HCPK5	–	–
50 x 5	200P10	BB7-5-505	HCPK5	–	–
50 x 6	250P10	BB7-5-506	HCPK5	–	–

Special moulds for all FurseWELD products can be manufactured to meet specific customer applications on request

FurseWELD

Bar to bar BB14

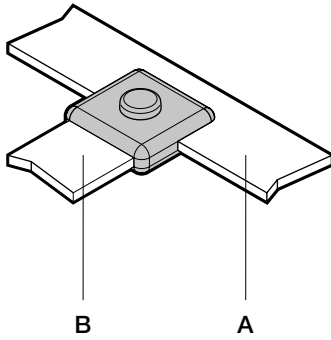

Bar to bar BB14 - FurseWELD

Flat tape conductor size A (mm)	Flat tape conductor size B (mm)	Part no.				
		Powder cartridge	Standard mould	Handle clamp	Mini mini mould	Handle clamp
20 x 3	20 x 3	45P10	BB14-4-203203	HCPK4	BB14-3-203203	HCPK3
25 x 3	25 x 3	65P10	BB14-4-253253	HCPK4	BB14-3-253253	HCPK3
25 x 4	25 x 4	90P10	BB14-4-254254	HCPK4	BB14-3-254254	HCPK3
25 x 6	25 x 6	115P10	BB14-4-256256	HCPK4	BB14-3-256256	HCPK3
30 x 2	30 x 2	65P10	BB14-4-302302	HCPK4	BB14-3-302302	HCPK3
30 x 3	30 x 3	65P10	BB14-4-303303	HCPK4	BB14-3-303303	HCPK3
30 x 4	30 x 4	90P10	BB14-4-304304	HCPK4	BB14-3-304304	HCPK3
30 x 5	30 x 5	115P10	BB14-4-305305	HCPK4	BB14-3-305305	HCPK3
31 x 3	31 x 3	90P10	BB14-4-313313	HCPK4	BB14-3-313313	HCPK3
31 x 6	31 x 6	150P10	BB14-4-316316	HCPK4	—	—
38 x 3	38 x 3	90P10	BB14-4-383383	HCPK4	—	—
38 x 5	38 x 5	150P10	BB14-4-385385	HCPK4	—	—
38 x 6	38 x 6	200P10	BB14-4-386386	HCPK4	—	—
40 x 3	40 x 3	90P10	BB14-4-403403	HCPK4	—	—
40 x 4	40 x 4	115P10	BB14-4-404404	HCPK4	—	—
40 x 5	40 x 5	150P10	BB14-4-405405	HCPK4	—	—
40 x 6	40 x 6	200P10	BB14-4-406406	HCPK4	—	—
50 x 3	50 x 3	150P10	BB14-5-503503	HCPK5	—	—
50 x 4	50 x 4	200P10	BB14-5-504504	HCPK5	—	—
50 x 5	50 x 5	200P10	BB14-5-505505	HCPK5	—	—
50 x 6	50 x 6	250P10	BB14-5-506506	HCPK5	—	—

Special moulds for all FurseWELD products can be manufactured to meet specific customer applications on request

FurseWELD

Bar to bar BB41

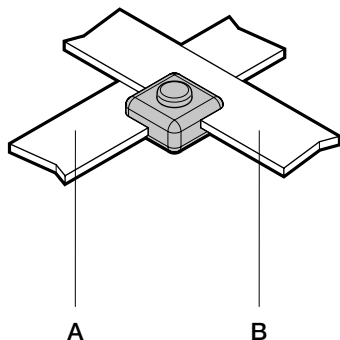

Bar to bar BB41 - FurseWELD

Flat tape conductor size A (mm)	Flat tape conductor size B (mm)	Part no.				
		Powder cartridge	Standard mould	Handle clamp	Mini mould	Mini handle clamp
20 x 3	20 x 3	65P10	BB41-4-203203	HCPK4	BB41-3-203203	HCPK3
25 x 3	25 x 3	65P10	BB41-4-253253	HCPK4	BB41-3-253253	HCPK3
25 x 4	25 x 4	90P10	BB41-4-254254	HCPK4	BB41-3-254254	HCPK3
25 x 6	25 x 6	115P10	BB41-4-256256	HCPK4	BB41-3-256256	HCPK3
30 x 2	30 x 2	65P10	BB41-4-302302	HCPK4	BB41-3-302302	HCPK3
30 x 3	30 x 3	115P10	BB41-4-303303	HCPK4	BB41-3-303303	HCPK3
30 x 4	30 x 4	115P10	BB41-4-304304	HCPK4	BB41-3-304304	HCPK3
30 x 5	30 x 5	115P10	BB41-4-305305	HCPK4	BB41-3-305305	HCPK3
31 x 3	31 x 3	115P10	BB41-4-313313	HCPK4	BB41-3-313313	HCPK3
31 x 6	31 x 6	115P10	BB41-4-316316	HCPK4	BB41-3-316316	HCPK3
38 x 3	38 x 3	150P10	BB41-4-383383	HCPK4	—	—
38 x 5	38 x 5	150P10	BB41-4-385385	HCPK4	—	—
38 x 6	38 x 6	200P10	BB41-4-386386	HCPK4	—	—
40 x 3	40 x 3	200P10	BB41-4-403403	HCPK4	—	—
40 x 4	40 x 4	200P10	BB41-4-404404	HCPK4	—	—
40 x 5	40 x 5	200P10	BB41-4-405405	HCPK4	—	—
40 x 6	40 x 6	200P10	BB41-4-406406	HCPK4	—	—
50 x 3	50 x 3	200P10	BB41-5-503503	HCPK5	—	—
50 x 4	50 x 4	200P10	BB41-5-504504	HCPK5	—	—
50 x 5	50 x 5	200P10	BB41-5-505505	HCPK5	—	—
50 x 6	50 x 6	200P10	BB41-5-506506	HCPK5	—	—

Special moulds for all FurseWELD products can be manufactured to meet specific customer applications on request

FurseWELD

Bar to steel surface BS1

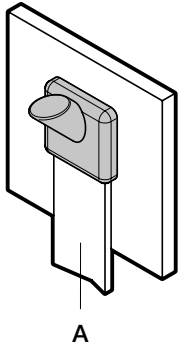

Bar to steel surface BS1 - FurseWELD

Flat Tape conductor size A (mm)	Part no.				
	Powder cartridge	Standard mould	Handle clamp	Mini mould	Mini handle clamp
20 x 3	65P10	BS1-4-203	HCPK4	BS1-3-203	HCPK3
25 x 3	90P10	BS1-4-253	HCPK4	BS1-3-253	HCPK3
25 x 4	90P10	BS1-4-254	HCPK4	BS1-3-254	HCPK3
25 x 6	150P10	BS1-4-256	HCPK4	–	–
30 x 2	90P10	BS1-4-302	HCPK4	BS1-3-302	HCPK3
30 x 3	90P10	BS1-4-303	HCPK4	BS1-3-303	HCPK3
30 x 4	115P10	BS1-4-304	HCPK4	BS1-3-304	HCPK3
30 x 5	150P10	BS1-4-305	HCPK4	–	–
31 x 3	90P10	BS1-4-313	HCPK4	BS1-3-313	HCPK3
31 x 6	200P10	BS1-4-316	HCPK4	–	–
38 x 3	150P10	BS1-4-383	HCPK4	–	–
38 x 5	200P10	BS1-4-385	HCPK4	–	–
38 x 6	250P10	BS1-4-386	HCPK4	–	–
40 x 3	150P10	BS1-4-403	HCPK4	–	–
40 x 4	200P10	BS1-4-404	HCPK4	–	–
40 x 5	200P10	BS1-4-405	HCPK4	–	–
40 x 6	250P10	BS1-4-406	HCPK4	–	–
50 x 3	200P10	BS1-4-503	HCPK4	–	–
50 x 4	250P10	BS1-4-504	HCPK4	–	–
50 x 5	250P10	BS1-4-505	HCPK4	–	–
50 x 6	2 x 150P10	BS1-5-506	HCPK5	–	–

Special moulds for all FurseWELD products can be manufactured to meet specific customer applications on request

FurseWELD

Bar to steel surface BS2

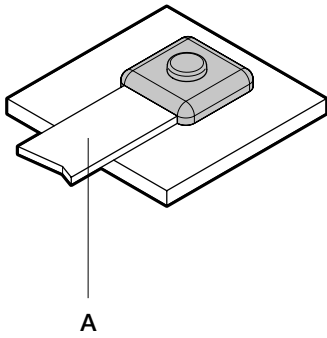

Bar to steel surface BS2 - FurseWELD

Flat tape conductor size A (mm)	Part no.				
	Powder cartridge	Standard mould	Handle clamp	Mini mould	Mini handle clamp
20 x 3	90P10	BS2-4-203	HCPK4	BS2-3-203	HCPK3
25 x 3	90P10	BS2-4-253	HCPK4	BS2-3-253	HCPK3
25 x 4	90P10	BS2-4-254	HCPK4	BS2-3-254	HCPK3
25 x 6	150P10	BS2-4-256	HCPK4	–	–
30 x 2	115P10	BS2-4-302	HCPK4	BS2-3-302	HCPK3
30 x 3	115P10	BS2-4-303	HCPK4	BS2-3-303	HCPK3
30 x 4	150P10	BS2-4-304	HCPK4	–	–
30 x 5	200P10	BS2-4-305	HCPK4	–	–
31 x 3	115P10	BS2-4-313	HCPK4	BS2-3-313	HCPK3
31 x 6	200P10	BS2-4-316	HCPK4	–	–
38 x 3	150P10	BS2-4-383	HCPK4	–	–
38 x 5	200P10	BS2-4-385	HCPK4	–	–
38 x 6	200P10	BS2-4-386	HCPK4	–	–
40 x 3	115P10	BS2-4-403	HCPK4	–	–
40 x 4	200P10	BS2-4-404	HCPK4	–	–
40 x 5	200P10	BS2-4-405	HCPK4	–	–
40 x 6	250P10	BS2-4-406	HCPK4	–	–
50 x 3	200P10	BS2-4-503	HCPK4	–	–
50 x 4	2 x 150P10	BS2-5-504	HCPK5	–	–
50 x 5	2 x 150P10	BS2-5-505	HCPK5	–	–
50 x 6	2 x 150P10	BS2-5-506	HCPK5	–	–

Special moulds for all FurseWELD products can be manufactured to meet specific customer applications on request

FurseWELD

Bar to steel surface BS3

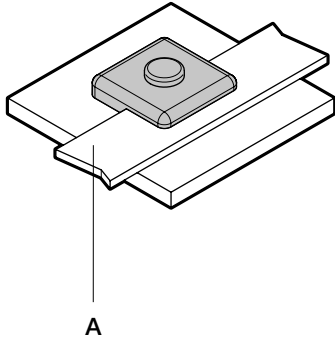

Bar to steel surface BS3 - FurseWELD

Flat tape conductor size A (mm)	Part no.				
	Powder cartridge	Standard mould	Handle clamp	Mini mould	Mini handle clamp
20 x 3	90P10	BS3-4-203	HCPK4	BS3-3-203	HCPK3
25 x 3	115P10	BS3-4-253	HCPK4	BS3-3-253	HCPK3
25 x 4	115P10	BS3-4-254	HCPK4	BS3-3-254	HCPK3
25 x 6	150P10	BS3-4-256	HCPK4	-	-
30 x 2	115P10	BS3-4-302	HCPK4	BS3-3-302	HCPK3
30 x 3	115P10	BS3-4-303	HCPK4	BS3-3-303	HCPK3
30 x 4	150P10	BS3-4-304	HCPK4	-	-
30 x 5	200P10	BS3-4-305	HCPK4	-	-
31 x 3	115P10	BS3-4-313	HCPK4	BS3-3-313	HCPK3
31 x 6	200P10	BS3-4-316	HCPK4	-	-
38 x 3	150P10	BS3-4-383	HCPK4	-	-
38 x 5	200P10	BS3-4-385	HCPK4	-	-
38 x 6	250P10	BS3-4-386	HCPK4	-	-
40 x 3	150P10	BS3-4-403	HCPK4	-	-
40 x 4	200P10	BS3-4-404	HCPK4	-	-
40 x 5	250P10	BS3-4-405	HCPK4	-	-
40 x 6	250P10	BS3-4-406	HCPK4	-	-
50 x 3	250P10	BS3-4-503	HCPK4	-	-
50 x 4	250P10	BS3-4-504	HCPK4	-	-
50 x 5	250P10	BS3-4-505	HCPK4	-	-
50 x 6	250P10	BS3-4-506	HCPK4	-	-

Special moulds for all FurseWELD products can be manufactured to meet specific customer applications on request

FurseWELD

Bar to earth rod BR1

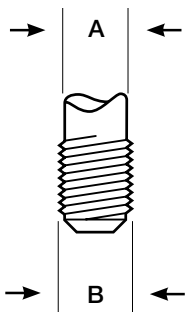
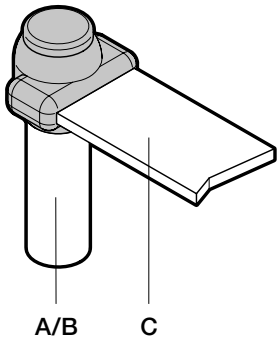

Bar to earth rod BR1 - FurseWELD

Earth rod A ø (mm)	Earth rod B ø (")	Flat tape conductor size C (mm)	Part no.				
			Powder cartridge	Standard mould	Handle clamp	Mini mould	Mini handle clamp
12.7	½	20 x 3	90P10	BR1-4-127203	HCPK4	BR1-3-128203	HCPK3
12.7	½	25 x 3	90P10	BR1-4-127253	HCPK4	BR1-3-128253	HCPK3
12.7	½	25 x 4	90P10	BR1-4-127254	HCPK4	BR1-3-128254	HCPK3
12.7	½	30 x 2	90P10	BR1-4-127302	HCPK4	BR1-3-128302	HCPK3
12.7	½	30 x 3	90P10	BR1-4-127303	HCPK4	BR1-3-128303	HCPK3
12.7	½	31 x 3	90P10	BR1-4-127313	HCPK4	BR1-3-128313	HCPK3
12.7	½	38 x 3	90P10	BR1-4-127383	HCPK4	-	-
12.7	½	40 x 3	90P10	BR1-4-127403	HCPK4	-	-
12.7	½	50 x 3	115P10	BR1-4-127503	HCPK4	-	-
12.7	½	50 x 6	115P10	BR1-4-127506	HCPK4	-	-
14.2	¾	20 x 3	90P10	BR1-4-142203	HCPK4	BR1-3-142203	HCPK3
14.2	¾	25 x 3	90P10	BR1-4-142253	HCPK4	BR1-3-142253	HCPK3
14.2	¾	25 x 4	115P10	BR1-4-142254	HCPK4	BR1-3-142254	HCPK3
14.2	¾	25 x 6	115P10	BR1-4-142256	HCPK4	BR1-3-142256	HCPK3
14.2	¾	30 x 2	115P10	BR1-4-142302	HCPK4	BR1-3-142302	HCPK3
14.2	¾	30 x 3	115P10	BR1-4-142303	HCPK4	BR1-3-142303	HCPK3
14.2	¾	30 x 4	150P10	BR1-4-142304	HCPK4	-	-
14.2	¾	30 x 5	150P10	BR1-4-142305	HCPK4	-	-
14.2	¾	31 x 3	115P10	BR1-4-142313	HCPK4	BR1-3-142313	HCPK3
14.2	¾	31 x 6	150P10	BR1-4-142316	HCPK4	-	-
14.2	¾	38 x 3	115P10	BR1-4-142383	HCPK4	-	-
14.2	¾	38 x 5	150P10	BR1-4-142385	HCPK4	-	-
14.2	¾	38 x 6	200P10	BR1-4-142386	HCPK4	-	-
14.2	¾	40 x 3	115P10	BR1-4-142403	HCPK4	-	-
14.2	¾	40 x 4	150P10	BR1-4-142404	HCPK4	-	-
14.2	¾	40 x 5	150P10	BR1-4-142405	HCPK4	-	-
14.2	¾	40 x 6	200P10	BR1-4-142406	HCPK4	-	-
14.2	¾	50 x 3	150P10	BR1-4-142503	HCPK4	-	-
14.2	¾	50 x 4	200P10	BR1-4-142504	HCPK4	-	-
14.2	¾	50 x 5	200P10	BR1-4-142505	HCPK4	-	-
14.2	¾	50 x 6	200P10	BR1-4-142506	HCPK4	-	-

Suitable for connections to copperbond rods - for connections to solid copper and stainless steel rods please contact our sales office

Threaded portion of copperbond rods must be removed prior to welding

Special moulds for all FurseWELD products can be manufactured to meet specific customer applications on request

FurseWELD

Bar to earth rod BR1

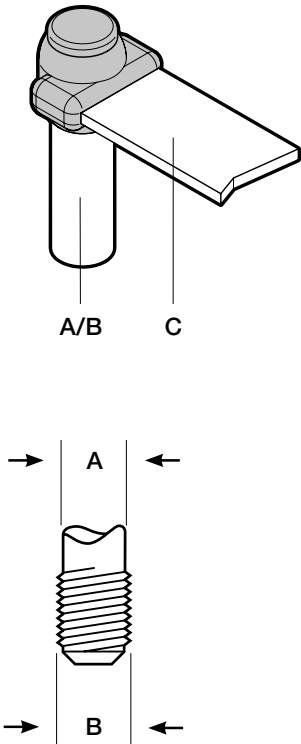

Bar to earth rod BR1 (continued) - FurseWELD

Earth rod A ø (mm)	Earth rod B ø (")	Flat tape conductor size C (mm)	Part no.				
			Powder cartridge	Standard mould	Handle clamp	Mini mould	Mini handle clamp
17.2	¾	20 x 3	115P10	BR1-4-172203	HCPK4	BR1-3-172203	HCPK3
17.2	¾	25 x 3	150P10	BR1-4-172253	HCPK4	-	-
17.2	¾	25 x 4	150P10	BR1-4-172254	HCPK4	-	-
17.2	¾	25 x 6	200P10	BR1-4-172256	HCPK4	-	-
17.2	¾	30 x 2	150P10	BR1-4-172302	HCPK4	-	-
17.2	¾	30 x 3	150P10	BR1-4-172303	HCPK4	-	-
17.2	¾	30 x 4	250P10	BR1-4-172304	HCPK4	-	-
17.2	¾	30 x 5	200P10	BR1-4-172305	HCPK4	-	-
17.2	¾	31 x 3	150P10	BR1-4-172313	HCPK4	-	-
17.2	¾	31 x 6	250P10	BR1-4-172316	HCPK4	-	-
17.2	¾	38 x 3	200P10	BR1-4-172383	HCPK4	-	-
17.2	¾	38 x 5	200P10	BR1-4-172385	HCPK4	-	-
17.2	¾	38 x 6	2 x 150P10	BR1-5-172386	HCPK5	-	-
17.2	¾	40 x 3	200P10	BR1-4-172403	HCPK4	-	-
17.2	¾	40 x 4	200P10	BR1-4-172404	HCPK4	-	-
17.2	¾	40 x 5	200P10	BR1-4-172405	HCPK4	-	-
17.2	¾	40 x 6	2 x 150P10	BR1-5-172406	HCPK5	-	-
17.2	¾	50 x 3	2 x 150P10	BR1-5-172503	HCPK5	-	-
17.2	¾	50 x 4	2 x 150P10	BR1-5-172504	HCPK5	-	-
17.2	¾	50 x 5	2 x 150P10	BR1-5-172505	HCPK5	-	-
17.2	¾	50 x 6	2 x 200P10	BR1-5-172506	HCPK5	-	-

Suitable for connections to copperbond rods - for connections to solid copper and stainless steel rods please contact our sales office
Threaded portion of copperbond rods must be removed prior to welding

Special moulds for all FurseWELD products can be manufactured to meet specific customer applications on request

FurseWELD

Bar to earth rod BR2

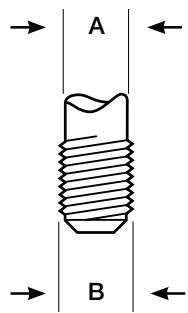
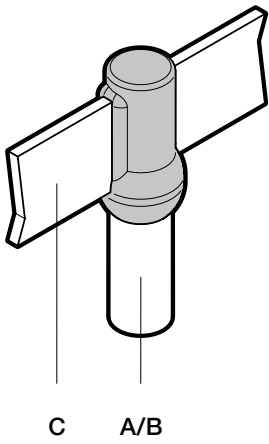

Bar to earth rod BR2 - FurseWELD

Earth rod A ø (mm)	Earth rod B ø (")	Flat tape conductor size C (mm)	Part no.				
			Powder cartridge	Standard mould	Handle clamp	Mini mould	Mini handle clamp
12.7	½	20 x 3	90P10	BR2-4-127203	HCPK4	BR2-3-128203	HCPK3
12.7	½	25 x 3	90P10	BR2-4-127253	HCPK4	BR2-3-128253	HCPK3
12.7	½	25 x 4	90P10	BR2-4-127254	HCPK4	BR2-3-128254	HCPK3
12.7	½	30 x 2	90P10	BR2-4-127302	HCPK4	BR2-3-128302	HCPK3
12.7	½	30 x 3	90P10	BR2-4-127303	HCPK4	BR2-3-128303	HCPK3
12.7	½	31 x 3	90P10	BR2-4-127313	HCPK4	BR2-3-128313	HCPK3
12.7	½	38 x 3	90P10	BR2-4-127383	HCPK4	BR2-3-128383	HCPK3
12.7	½	40 x 3	90P10	BR2-4-127403	HCPK4	BR2-3-128403	HCPK3
12.7	½	50 x 3	115P10	BR2-4-127503	HCPK4	-	-
14.2	⅝	20 x 3	90P10	BR2-4-142203	HCPK4	BR2-3-142203	HCPK3
14.2	⅝	25 x 3	90P10	BR2-4-142253	HCPK4	BR2-3-142253	HCPK3
14.2	⅝	25 x 4	115P10	BR2-4-142254	HCPK4	BR2-3-142254	HCPK3
14.2	⅝	25 x 6	150P10	BR2-4-142256	HCPK4	-	-
14.2	⅝	30 x 2	90P10	BR2-4-142302	HCPK4	BR2-3-142302	HCPK3
14.2	⅝	30 x 3	115P10	BR2-4-142303	HCPK4	BR2-3-142303	HCPK3
14.2	⅝	30 x 4	150P10	BR2-4-142304	HCPK4	-	-
14.2	⅝	30 x 5	150P10	BR2-4-142305	HCPK4	-	-
14.2	⅝	31 x 3	115P10	BR2-4-142313	HCPK4	BR2-3-142313	HCPK3
14.2	⅝	31 x 6	150P10	BR2-4-142316	HCPK4	-	-
14.2	⅝	38 x 3	150P10	BR2-4-142383	HCPK4	-	-
14.2	⅝	38 x 5	150P10	BR2-4-142385	HCPK4	-	-
14.2	⅝	38 x 6	200P10	BR2-4-142386	HCPK4	-	-
14.2	⅝	40 x 3	150P10	BR2-4-142403	HCPK4	-	-
14.2	⅝	40 x 4	150P10	BR2-4-142404	HCPK4	-	-
14.2	⅝	40 x 5	150P10	BR2-4-142405	HCPK4	-	-
14.2	⅝	40 x 6	200P10	BR2-4-142406	HCPK4	-	-
14.2	⅝	50 x 3	200P10	BR2-4-142503	HCPK4	-	-
14.2	⅝	50 x 4	200P10	BR2-4-142504	HCPK4	-	-
14.2	⅝	50 x 5	200P10	BR2-4-142505	HCPK4	-	-
14.2	⅝	50 x 6	250P10	BR2-4-142506	HCPK4	-	-

Suitable for connections to copperbond rods - for connections to solid copper and stainless steel rods please contact our sales office

Threaded portion of copperbond rods must be removed prior to welding

Special moulds for all FurseWELD products can be manufactured to meet specific customer applications on request

FurseWELD

Bar to earth rod BR2

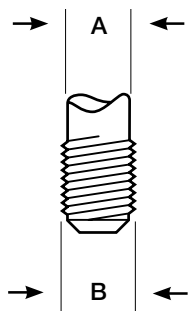
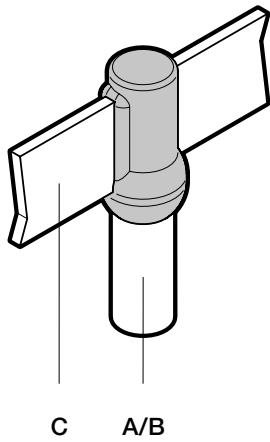

Bar to earth rod BR2 (continued) - FurseWELD

Earth rod A ø (mm)	Earth rod B ø (")	Flat tape conductor size C (mm)	Part no.				
			Powder cartridge	Standard mould	Handle clamp	Mini mould	Mini handle clamp
17.2	3/4	20 x 3	150P10	BR2-4-172203	HCPK4	-	-
17.2	3/4	25 x 3	150P10	BR2-4-172253	HCPK4	-	-
17.2	3/4	25 x 4	200P10	BR2-4-172254	HCPK4	-	-
17.2	3/4	25 x 6	200P10	BR2-4-172256	HCPK4	-	-
17.2	3/4	30 x 2	150P10	BR2-4-172302	HCPK4	-	-
17.2	3/4	30 x 3	150P10	BR2-4-172303	HCPK4	-	-
17.2	3/4	30 x 4	250P10	BR2-4-172304	HCPK4	-	-
17.2	3/4	30 x 5	200P10	BR2-4-172305	HCPK4	-	-
17.2	3/4	31 x 3	200P10	BR2-4-172313	HCPK4	-	-
17.2	3/4	31 x 6	250P10	BR2-4-172316	HCPK4	-	-
17.2	3/4	38 x 3	200P10	BR2-4-172383	HCPK4	-	-
17.2	3/4	38 x 5	200P10	BR2-4-172385	HCPK4	-	-
17.2	3/4	38 x 6	250P10	BR2-4-172386	HCPK4	-	-
17.2	3/4	40 x 3	200P10	BR2-4-172403	HCPK4	-	-
17.2	3/4	40 x 4	200P10	BR2-4-172404	HCPK4	-	-
17.2	3/4	40 x 5	200P10	BR2-4-172405	HCPK4	-	-
17.2	3/4	40 x 6	250P10	BR2-4-172406	HCPK4	-	-
17.2	3/4	50 x 3	2 x 150P10	BR2-5-172503	HCPK5	-	-
17.2	3/4	50 x 4	2 x 150P10	BR2-5-172504	HCPK5	-	-
17.2	3/4	50 x 5	2 x 150P10	BR2-5-172505	HCPK5	-	-
17.2	3/4	50 x 6	2 x 150P10	BR2-5-172506	HCPK5	-	-

Suitable for connections to copperbond rods - for connections to solid copper and stainless steel rods please contact our sales office
Threaded portion of copperbond rods must be removed prior to welding

Special moulds for all FurseWELD products can be manufactured to meet specific customer applications on request

FurseWELD

Bar to earth rod BR7

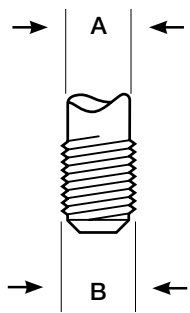
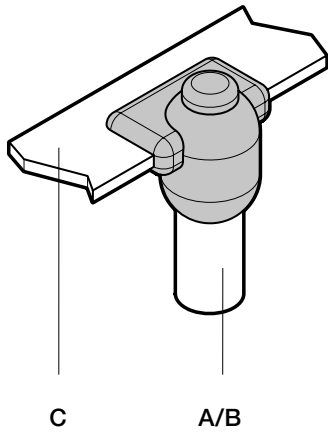

Bar to earth rod BR7 - FurseWELD

Earth rod A ø (mm)	Earth rod B ø (")	Flat tape conductor size C (mm)	Part no.				
			Powder cartridge	Standard mould	Handle clamp	Mini mould	Mini handle clamp
12.7	½	20 x 3	90P10	BR7-4-127203	HCPK4	BR7-3-127203	HCPK3
12.7	½	25 x 3	90P10	BR7-4-127253	HCPK4	BR7-3-127253	HCPK3
12.7	½	25 x 4	90P10	BR7-4-127254	HCPK4	BR7-3-127254	HCPK3
12.7	½	30 x 2	90P10	BR7-4-127302	HCPK4	BR7-3-127302	HCPK3
12.7	½	30 x 3	90P10	BR7-4-127303	HCPK4	BR7-3-127303	HCPK3
12.7	½	31 x 3	90P10	BR7-4-127313	HCPK4	BR7-3-127313	HCPK3
12.7	½	38 x 3	90P10	BR7-4-127383	HCPK4	-	-
12.7	½	40 x 3	90P10	BR7-4-127403	HCPK4	-	-
12.7	½	50 x 3	115P10	BR7-4-127503	HCPK4	-	-
12.7	½	50 x 6	115P10	BR7-4-127506	HCPK4	-	-
14.2	¾	20 x 3	90P10	BR7-4-142203	HCPK4	BR7-3-142203	HCPK3
14.2	¾	25 x 3	90P10	BR7-4-142253	HCPK4	BR7-3-142253	HCPK3
14.2	¾	25 x 4	115P10	BR7-4-142254	HCPK4	BR7-3-142254	HCPK3
14.2	¾	25 x 6	115P10	BR7-4-142256	HCPK4	BR7-3-142256	HCPK3
14.2	¾	30 x 2	115P10	BR7-4-142302	HCPK4	BR7-3-142302	HCPK3
14.2	¾	30 x 3	115P10	BR7-4-142303	HCPK4	BR7-3-142303	HCPK3
14.2	¾	30 x 4	150P10	BR7-4-142304	HCPK4	-	-
14.2	¾	30 x 5	150P10	BR7-4-142305	HCPK4	-	-
14.2	¾	31 x 3	115P10	BR7-4-142313	HCPK4	BR7-3-142313	HCPK3
14.2	¾	31 x 6	150P10	BR7-4-142316	HCPK4	-	-
14.2	¾	38 x 3	115P10	BR7-4-142383	HCPK4	-	-
14.2	¾	38 x 5	150P10	BR7-4-142385	HCPK4	-	-
14.2	¾	38 x 6	200P10	BR7-4-142386	HCPK4	-	-
14.2	¾	40 x 3	115P10	BR7-4-142403	HCPK4	-	-
14.2	¾	40 x 4	150P10	BR7-4-142404	HCPK4	-	-
14.2	¾	40 x 5	150P10	BR7-4-142405	HCPK4	-	-
14.2	¾	40 x 6	200P10	BR7-4-142406	HCPK4	-	-
14.2	¾	50 x 3	150P10	BR7-4-142503	HCPK4	-	-
14.2	¾	50 x 4	200P10	BR7-4-142504	HCPK4	-	-
14.2	¾	50 x 5	200P10	BR7-4-142505	HCPK4	-	-
14.2	¾	50 x 6	200P10	BR7-4-142506	HCPK4	-	-

Suitable for connections to copperbond rods - for connections to solid copper and stainless steel rods please contact our sales office
Threaded portion of copperbond rods must be removed prior to welding

Special moulds for all FurseWELD products can be manufactured to meet specific customer applications on request

FurseWELD

Bar to earth rod BR7

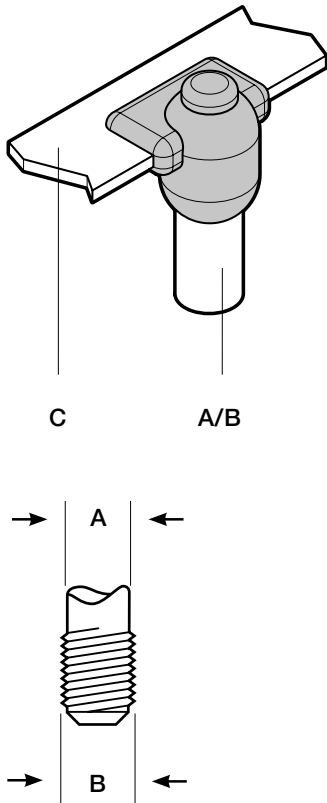

Bar to earth rod BR7 (continued) - FurseWELD

Earth rod A ø (mm)	Earth rod B ø (")	Flat tape conductor size C (mm)	Part no.				
			Powder cartridge	Standard mould	Handle clamp	Mini mould	Mini handle clamp
17.2	¾	20 x 3	115P10	BR7-4-172203	HCPK4	BR7-3-172203	HCPK3
17.2	¾	25 x 3	150P10	BR7-4-172253	HCPK4	-	-
17.2	¾	25 x 4	150P10	BR7-4-172254	HCPK4	-	-
17.2	¾	25 x 6	200P10	BR7-4-172256	HCPK4	-	-
17.2	¾	30 x 2	150P10	BR7-4-172302	HCPK4	-	-
17.2	¾	30 x 3	150P10	BR7-4-172303	HCPK4	-	-
17.2	¾	30 x 4	250P10	BR7-4-172304	HCPK4	-	-
17.2	¾	30 x 5	200P10	BR7-4-172305	HCPK4	-	-
17.2	¾	31 x 3	200P10	BR7-4-172313	HCPK4	-	-
17.2	¾	31 x 6	200P10	BR7-4-172316	HCPK4	-	-
17.2	¾	38 x 3	200P10	BR7-4-172383	HCPK4	-	-
17.2	¾	38 x 5	200P10	BR7-4-172385	HCPK4	-	-
17.2	¾	38 x 6	250P10	BR7-5-172386	HCPK5	-	-
17.2	¾	40 x 3	200P10	BR7-4-172403	HCPK4	-	-
17.2	¾	40 x 4	200P10	BR7-4-172404	HCPK4	-	-
17.2	¾	40 x 5	200P10	BR7-4-172405	HCPK4	-	-
17.2	¾	40 x 6	250P10	BR7-5-172406	HCPK5	-	-
17.2	¾	50 x 3	250P10	BR7-5-172503	HCPK5	-	-
17.2	¾	50 x 4	250P10	BR7-5-172504	HCPK5	-	-
17.2	¾	50 x 5	2 x 150P10	BR7-5-172505	HCPK5	-	-
17.2	¾	50 x 6	2 x 200P10	BR7-5-172506	HCPK5	-	-

Suitable for connections to copperbond rods - for connections to solid copper and stainless steel rods please contact our sales office
Threaded portion of copperbond rods must be removed prior to welding

Special moulds for all FurseWELD products can be manufactured to meet specific customer applications on request

FurseWELD

Cable to bar CB1

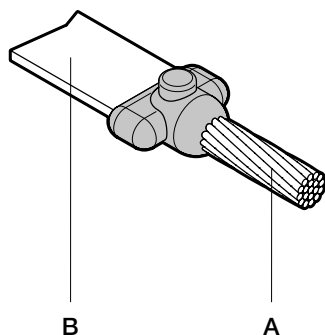

Cable to bar CB1 - FurseWELD

Stranded / solid circular conductor size A (mm ²)	Flat tape conductor size B (mm)	Part no.				
		Powder cartridge	Standard mould	Handle clamp	Mini mould	Mini handle clamp
16 *	20 x 3	45P10	CB1-4-16203	HCPK4	CB1-3-16203	HCPK3
16 *	25 x 3	45P10	CB1-4-16253	HCPK4	CB1-3-16253	HCPK3
25	20 x 3	32P10	CB1-4-25203	HCPK4	CB1-3-25203	HCPK3
25	25 x 3	45P10	CB1-4-25253	HCPK4	CB1-3-25253	HCPK3
35	20 x 3	45P10	CB1-4-35203	HCPK4	CB1-3-35203	HCPK3
35	25 x 3	45P10	CB1-4-35253	HCPK4	CB1-3-35253	HCPK3
50	20 x 3	45P10	CB1-4-50203	HCPK4	CB1-3-50203	HCPK3
50	25 x 3	65P10	CB1-4-50253	HCPK4	CB1-3-50253	HCPK3
Ø 8	20 x 3	45P10	CB1-4-8SC203	HCPK4	CB1-3-8SC203	HCPK3
Ø 8	25 x 3	65P10	CB1-4-8SC253	HCPK4	CB1-3-8SC253	HCPK3
70	25 x 3	65P10	CB1-4-70253	HCPK4	CB1-3-70253	HCPK3
70	25 x 4	65P10	CB1-4-70254	HCPK4	CB1-3-70254	HCPK3
70	25 x 6	65P10	CB1-4-70256	HCPK4	CB1-3-70256	HCPK3
Ø 10	25 x 3	65P10	CB1-4-10SC253	HCPK4	CB1-3-10SC253	HCPK3
Ø 10	25 x 4	65P10	CB1-4-10SC254	HCPK4	CB1-3-10SC254	HCPK3
Ø 10	25 x 6	65P10	CB1-4-10SC256	HCPK4	CB1-3-10SC256	HCPK3
95	25 x 4	90P10	CB1-4-95254	HCPK4	CB1-3-95254	HCPK3
95	25 x 6	90P10	CB1-4-95256	HCPK4	CB1-3-95256	HCPK3
120	25 x 6	90P10	CB1-4-120256	HCPK4	CB1-3-120256	HCPK3
120	30 x 5	115P10	CB1-4-120305	HCPK4	CB1-3-120305	HCPK3
150	25 x 6	115P10	CB1-4-150256	HCPK4	CB1-3-150256	HCPK3
150	30 x 5	115P10	CB1-4-150305	HCPK4	CB1-3-150305	HCPK3
150	40 x 5	150P10	CB1-4-150405	HCPK4	—	—
185	31 x 6	150P10	CB1-4-185316	HCPK4	—	—
185	40 x 5	150P10	CB1-4-185405	HCPK4	—	—
185	50 x 5	200P10	CB1-5-185505	HCPK5	—	—
240	50 x 5	200P10	CB1-5-240505	HCPK5	—	—
240	50 x 6	2 x 150P10	CB1-5-240506	HCPK5	—	—
300	50 x 6	2 x 150P10	CB1-5-300506	HCPK5	—	—

Special moulds for all FurseWELD products can be manufactured to meet specific customer applications on request

*1 x S103 Sleeve required when joining conductors 16 mm² or smaller

FurseWELD

Cable to bar CB4

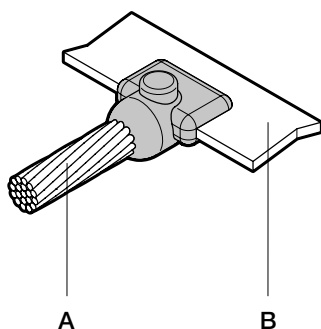

Cable to bar CB4 - FurseWELD

Stranded / solid circular conductor size A (mm ²)	Flat tape conductor size B (mm)	Part no.				
		Powder cartridge	Standard mould	Handle clamp	Mini mould	Mini handle clamp
16 *	20 x 3	45P10	CB4-4-16203	HCPK4	CB4-3-16203	HCPK3
16 *	25 x 3	45P10	CB4-4-16253	HCPK4	CB4-3-16253	HCPK3
25	20 x 3	45P10	CB4-4-25203	HCPK4	CB4-3-25203	HCPK3
25	25 x 3	45P10	CB4-4-25253	HCPK4	CB4-3-25253	HCPK3
35	20 x 3	45P10	CB4-4-35203	HCPK4	CB4-3-35203	HCPK3
35	25 x 3	45P10	CB4-4-35253	HCPK4	CB4-3-35253	HCPK3
50	20 x 3	45P10	CB4-4-50203	HCPK4	CB4-3-50203	HCPK3
50	25 x 3	45P10	CB4-4-50253	HCPK4	CB4-3-50253	HCPK3
Ø 8	20 x 3	45P10	CB4-4-8SC203	HCPK4	CB4-3-8SC203	HCPK3
Ø 8	25 x 3	45P10	CB4-4-8SC253	HCPK4	CB4-3-8SC253	HCPK3
70	25 x 3	65P10	CB4-4-70253	HCPK4	CB4-3-70253	HCPK3
70	25 x 4	65P10	CB4-4-70254	HCPK4	CB4-3-70254	HCPK3
70	25 x 6	90P10	CB4-4-70256	HCPK4	CB4-3-70256	HCPK3
Ø 10	25 x 3	65P10	CB4-4-10SC253	HCPK4	CB4-3-10SC253	HCPK3
Ø 10	25 x 4	65P10	CB4-4-10SC254	HCPK4	CB4-3-10SC254	HCPK3
Ø 10	25 x 6	90P10	CB4-4-10SC256	HCPK4	CB4-3-10SC256	HCPK3
95	25 x 4	90P10	CB4-4-95254	HCPK4	CB4-3-95254	HCPK3
95	25 x 6	115P10	CB4-4-95256	HCPK4	CB4-3-95256	HCPK3
120	25 x 6	115P10	CB4-4-120256	HCPK4	CB4-3-120256	HCPK3
120	30 x 5	115P10	CB4-4-120305	HCPK4	CB4-3-120305	HCPK3
150	25 x 6	115P10	CB4-4-150256	HCPK4	CB4-3-150256	HCPK3
150	30 x 5	115P10	CB4-4-150305	HCPK4	CB4-3-150305	HCPK3
150	40 x 5	115P10	CB4-4-150405	HCPK4	—	—
185	31 x 6	150P10	CB4-4-185316	HCPK4	—	—
185	40 x 5	150P10	CB4-4-185405	HCPK4	—	—
185	50 x 5	150P10	CB4-4-185505	HCPK4	—	—
240	50 x 5	200P10	CB4-4-240505	HCPK4	—	—
240	50 x 6	250P10	CB4-4-240506	HCPK4	—	—
300	50 x 6	2 x 150P10	CB4-5-300506	HCPK5	—	—

Special moulds for all FurseWELD products can be manufactured to meet specific customer applications on request
 *1 x S103 Sleeve required when joining conductors 16 mm² or smaller

FurseWELD

Cable to bar CB5

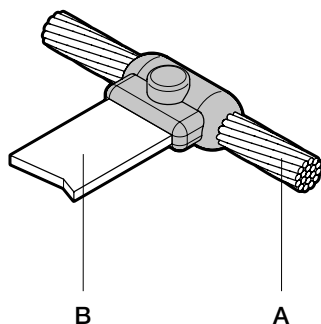

Cable to bar CB5 - FurseWELD

Stranded / solid circular conductor size A (mm ²)	Flat tape conductor size B (mm)	Part no.				
		Powder cartridge	Standard mould	Handle clamp	Mini mould	Mini handle clamp
16*	20 x 3	45P10	CB5-4-16203	HCPK4	CB5-3-16303	HCPK3
16*	25 x 3	65P10	CB5-4-16253	HCPK4	CB5-3-16253	HCPK3
25	20 x 3	45P10	CB5-4-25203	HCPK4	CB5-3-25203	HCPK3
25	25 x 3	65P10	CB5-4-25253	HCPK4	CB5-3-25253	HCPK3
35	20 x 3	45P10	CB5-4-35203	HCPK4	CB5-3-35203	HCPK3
35	25 x 3	65P10	CB5-4-35253	HCPK4	CB5-3-35253	HCPK3
50	20 x 3	65P10	CB5-4-50203	HCPK4	CB5-3-50203	HCPK3
50	25 x 3	65P10	CB5-4-50253	HCPK4	CB5-3-50253	HCPK3
Ø 8	20 x 3	65P10	CB5-4-8SC203	HCPK4	CB5-3-8SC203	HCPK3
Ø 8	25 x 3	65P10	CB5-4-8SC253	HCPK4	CB5-3-8SC253	HCPK3
70	25 x 3	90P10	CB5-4-70253	HCPK4	CB5-3-70253	HCPK3
70	25 x 4	115P10	CB5-4-70254	HCPK4	CB5-3-70254	HCPK3
70	25 x 6	115P10	CB5-4-70256	HCPK4	CB5-3-70256	HCPK3
Ø 10	25 x 3	115P10	CB5-4-10SC253	HCPK4	CB5-3-10SC253	HCPK3
Ø 10	25 x 4	150P10	CB5-4-10SC254	HCPK4	-	-
Ø 10	25 x 6	150P10	CB5-4-10SC256	HCPK4	-	-
95	25 x 4	150P10	CB5-4-95254	HCPK4	-	-
95	25 x 6	150P10	CB5-4-95256	HCPK4	-	-
120	25 x 6	150P10	CB5-4-120256	HCPK4	-	-
120	30 x 5	200P10	CB5-4-120305	HCPK4	-	-
150	25 x 6	200P10	CB5-4-150256	HCPK4	-	-
150	30 x 5	200P10	CB5-4-150305	HCPK4	-	-
150	40 x 5	250P10	CB5-4-150405	HCPK4	-	-
185	31 x 6	250P10	CB5-4-185316	HCPK4	-	-
185	40 x 5	250P10	CB5-4-185405	HCPK4	-	-
185	50 x 5	2 x 150P10	CB5-5-185505	HCPK5	-	-
240	50 x 5	2 x 150P10	CB5-5-240505	HCPK5	-	-
240	50 x 6	2 x 200P10	CB5-5-240506	HCPK5	-	-
300	50 x 6	2 x 250P10	CB5-5-300506	HCPK5	-	-

Special moulds for all FurseWELD products can be manufactured to meet specific customer applications on request
 *2 x S103 Sleeve required when joining conductors 16 mm² or smaller

FurseWELD

Cable to cable CC1

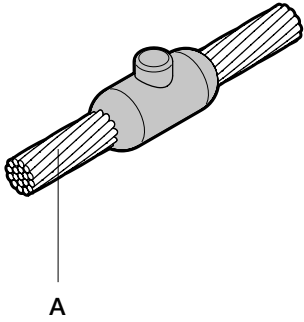

Cable to cable CC1 - FurseWELD

Stranded / solid circular conductor size A (mm ²)	Part no.				
	Powder cartridge	Standard mould	Handle clamp	Mini mould	Mini handle clamp
16*	32P10	CC1-4-16	HCPK4	CC1-3-16	HCPK3
25	32P10	CC1-4-25	HCPK4	CC1-3-25	HCPK3
35	32P10	CC1-4-35	HCPK4	CC1-3-35	HCPK3
50	45P10	CC1-4-50	HCPK4	CC1-3-50	HCPK3
Ø 8	45P10	CC1-4-8SC	HCPK4	CC1-3-8SC	HCPK3
70	65P10	CC1-4-70	HCPK4	CC1-3-70	HCPK3
Ø 10	65P10	CC1-4-10SC	HCPK4	CC1-3-10SC	HCPK3
95	90P10	CC1-4-95	HCPK4	CC1-3-95	HCPK3
120	115P10	CC1-4-120	HCPK4	CC1-3-120	HCPK3
150	115P10	CC1-4-150	HCPK4	CC1-3-150	HCPK3
185	150P10	CC1-4-185	HCPK4	—	—
240	200P10	CC1-4-240	HCPK4	—	—
300	250P10	CC1-4-300	HCPK4	—	—
400	2 x 150P10	CC1-5-400	HCPK5	—	—

Special moulds for all FurseWELD products can be manufactured to meet specific customer applications on request
 *2 x S103 Sleeve required when joining conductors 16 mm² or smaller

FurseWELD

Cable to cable CC2

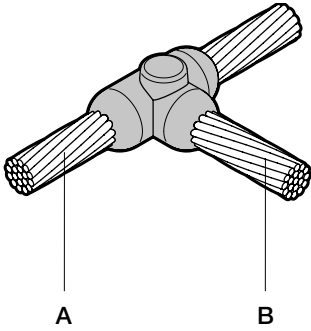

Cable to cable CC2 - FurseWELD

Stranded / solid circular conductor size A (mm ²)	Stranded / solid circular conductor size B (mm ²)	Part no.				
		Powder cartridge	Standard mould	Handle clamp	Mini mould	Mini handle clamp
16*	16*	45P10	CC2-4-1616	HCPK4	CC2-3-1616	HCPK3
25	25	45P10	CC2-4-2525	HCPK4	CC2-3-2525	HCPK3
35	35	45P10	CC2-4-3535	HCPK4	CC2-3-3535	HCPK3
35	25	45P10	CC2-4-3525	HCPK4	CC2-3-3525	HCPK3
Ø 8	Ø 8	65P10	CC2-4-88SC	HCPK4	CC2-3-88SC	HCPK3
50	50	90P10	CC2-4-5050	HCPK4	CC2-3-5050	HCPK3
50	35	65P10	CC2-4-5035	HCPK4	CC2-3-5035	HCPK3
50	25	65P10	CC2-4-5025	HCPK4	CC2-3-5025	HCPK3
Ø 10	Ø 10	90P10	CC2-4-1010SC	HCPK4	CC2-3-1010SC	HCPK3
70	70	90P10	CC2-4-7070	HCPK4	CC2-3-7070	HCPK3
70	50	90P10	CC2-4-7050	HCPK4	CC2-3-7050	HCPK3
70	3	65P10	CC2-4-7035	HCPK4	CC2-3-7035	HCPK3
70	25	65P10	CC2-4-7025	HCPK4	CC2-3-7025	HCPK3
95	95	115P10	CC2-4-9595	HCPK4	CC2-3-9595	HCPK3
95	70	90P10	CC2-4-9570	HCPK4	CC2-3-9570	HCPK3
95	50	90P10	CC2-4-9550	HCPK4	CC2-3-9550	HCPK3
95	35	90P10	CC2-4-9535	HCPK4	CC2-3-9535	HCPK3
120	120	150P10	CC2-4-120120	HCPK4	-	-
120	95	150P10	CC2-4-12095	HCPK4	-	-
120	70	90P10	CC2-4-12070	HCPK4	CC2-3-12070	HCPK3
120	50	90P10	CC2-4-12050	HCPK4	CC2-3-12050	HCPK3
150	150	200P10	CC2-4-150150	HCPK4	-	-
150	120	150P10	CC2-4-150120	HCPK4	-	-
150	95	150P10	CC2-4-15095	HCPK4	-	-
150	70	90P10	CC2-4-15070	HCPK4	CC2-3-15070	HCPK3
185	185	200P10	CC2-4-185185	HCPK4	-	-
185	150	200P10	CC2-4-185150	HCPK4	-	-
185	120	200P10	CC2-4-185120	HCPK4	-	-
185	95	150P10	CC2-4-18595	HCPK4	-	-
240	240	2 x 150P10	CC2-4-240240	HCPK4	-	-
240	185	200P10	CC2-4-240185	HCPK4	-	-
240	150	200P10	CC2-4-240150	HCPK4	-	-
240	120	200P10	CC2-4-240120	HCPK4	-	-
300	300	2 x 200P10	CC2-5-300300	HCPK5	-	-
300	240	2 x 200P10	CC2-5-300240	HCPK5	-	-
300	185	250P10	CC2-4-300185	HCPK4	-	-

Special moulds for all FurseWELD products can be manufactured to meet specific customer applications on request

*3 x S103 Sleeve required when joining conductors 16 mm² or smaller

FurseWELD

Cable to cable CC4

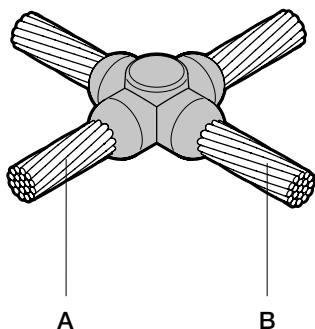

Cable to cable CC4 - FurseWELD

Stranded / solid circular conductor size A (mm ²)	Stranded solid circular conductor size B (mm ²)	Part no.				
		Powder cartridge	Standard mould	Handle clamp	Mini mould	Mini handle clamp
16 *	16 *	65P10	CC4-4-1616	HCPK4	CC4-3-1616	HCPK3
25	25	45P10	CC4-4-2525	HCPK4	CC4-3-2525	HCPK3
35	35	65P10	CC4-4-3535	HCPK4	CC4-3-3535	HCPK3
35	25	65P10	CC4-4-3525	HCPK4	CC4-3-3525	HCPK3
Ø 8	Ø 8	90P10	CC4-4-88SC	HCPK4	CC4-3-88SC	HCPK3
50	50	90P10	CC4-4-5050	HCPK4	CC4-3-5050	HCPK3
50	35	90P10	CC4-4-5035	HCPK4	CC4-3-5035	HCPK3
50	25	90P10	CC4-4-5025	HCPK4	CC4-3-5025	HCPK3
Ø 10	Ø 10	115P10	CC4-4-1010SC	HCPK4	CC4-3-1010SC	HCPK3
70	70	115P10	CC4-4-7070	HCPK4	CC4-3-7070	HCPK3
70	50	115P10	CC4-4-7050	HCPK4	CC4-3-7050	HCPK3
70	35	115P10	CC4-4-7035	HCPK4	CC4-3-7035	HCPK3
70	25	115P10	CC4-4-7025	HCPK4	CC4-3-7025	HCPK3
95	95	150P10	CC4-4-9595	HCPK4	—	—
95	70	150P10	CC4-4-9570	HCPK4	—	—
95	50	115P10	CC4-4-9550	HCPK4	—	—
95	35	115P10	CC4-4-9535	HCPK4	—	—
120	120	200P10	CC4-4-120120	HCPK4	—	—
120	95	200P10	CC4-4-12095	HCPK4	—	—
120	70	150P10	CC4-4-12070	HCPK4	—	—
120	50	150P10	CC4-4-12050	HCPK4	—	—
150	150	250P10	CC4-4-150150	HCPK4	—	—
150	120	250P10	CC4-4-150120	HCPK4	—	—
150	95	200P10	CC4-4-15095	HCPK4	—	—
150	70	150P10	CC4-4-15070	HCPK4	—	—
185	185	2 x 150P10	CC4-4-185185	HCPK4	—	—
185	150	250P10	CC4-4-185150	HCPK4	—	—
185	120	250P10	CC4-4-185120	HCPK4	—	—
185	95	200P10	CC4-4-18595	HCPK4	—	—
185	70	200P10	CC4-4-18570	HCPK4	—	—
240	240	2 x 250P10	CC4-5-240240	HCPK5	—	—
240	185	2 x 200P10	CC4-5-240185	HCPK5	—	—
240	150	2 x 200P10	CC4-5-240150	HCPK5	—	—
240	120	2 x 150P10	CC4-5-240120	HCPK5	—	—
300	300	3 x 200P10	CC4-5-300300	HCPK5	—	—

Special moulds for all FurseWELD products can be manufactured to meet specific customer applications on request

*4 x S103 Sleeve required when joining conductors 16 mm² or smaller

FurseWELD

Cable to cable CC6

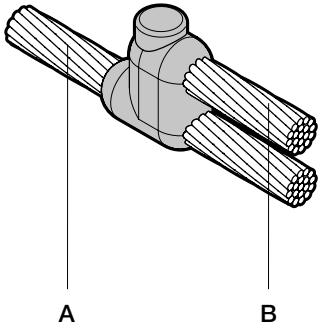

Cable to cable CC6 - FurseWELD

Stranded / solid circular conductor size A (mm ²)	Stranded solid circular conductor size B (mm ²)	Part no.				
		Powder cartridge	Standard mould	Handle clamp	Mini mould	Mini handle clamp
16 *	16 *	65P10	CC6-4-1616	HCPK4	CC6-3-1616	HCPK3
25	25	45P10	CC6-4-2525	HCPK4	CC6-3-2525	HCPK3
35	35	65P10	CC6-4-3535	HCPK4	CC6-3-3535	HCPK3
35	25	65P10	CC6-4-3525	HCPK4	CC6-3-3525	HCPK3
50	50	90P10	CC6-4-5050	HCPK4	CC6-3-5050	HCPK3
50	35	65P10	CC6-4-5035	HCPK4	CC6-3-5035	HCPK3
50	25	65P10	CC6-4-5025	HCPK4	CC6-3-5025	HCPK3
70	70	115P10	CC6-4-7070	HCPK4	CC6-3-7070	HCPK3
70	50	115P10	CC6-4-7050	HCPK4	CC6-3-7050	HCPK3
70	35	90P10	CC6-4-7035	HCPK4	CC6-3-7035	HCPK3
70	25	90P10	CC6-4-7025	HCPK4	CC6-3-7025	HCPK3
95	95	150P10	CC6-4-9595	HCPK4	—	—
95	70	115P10	CC6-4-9570	HCPK4	CC6-3-9570	HCPK3
95	50	115P10	CC6-4-9550	HCPK4	CC6-3-9550	HCPK3
95	35	115P10	CC6-4-9535	HCPK4	CC6-3-9535	HCPK3
120	120	200P10	CC6-4-120120	HCPK4	—	—
120	95	200P10	CC6-4-12095	HCPK4	—	—
120	70	150P10	CC6-4-12070	HCPK4	—	—
120	50	115P10	CC6-4-12050	HCPK4	CC6-3-12050	HCPK3

Special moulds for all FurseWELD products can be manufactured to meet specific customer applications on request

*3 x S103 Sleeve required when joining conductors 16 mm² or smaller

FurseWELD

Cable to cable CC7

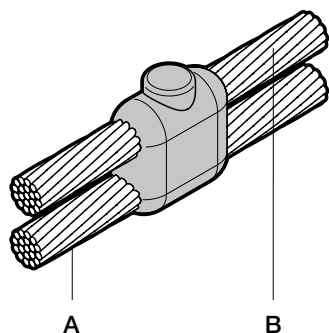

Cable to cable CC7 - FurseWELD

Stranded / solid circular conductor size A (mm ²)	Stranded solid circular conductor size B (mm ²)	Part no.				
		Powder cartridge	Standard mould	Handle clamp	Mini mould	Mini handle clamp
16 *	16 *	65P10	CC7-4-1616	HCPK4	CC7-3-1616	HCPK3
25	25	45P10	CC7-4-2525	HCPK4	CC7-3-2525	HCPK3
35	35	65P10	CC7-4-3535	HCPK4	CC7-3-3535	HCPK3
35	25	65P10	CC7-4-3525	HCPK4	CC7-3-3525	HCPK3
Ø 8	Ø 8	90P10	CC7-4-88SC	HCPK4	CC7-3-88SC	HCPK3
50	50	90P10	CC7-4-5050	HCPK4	CC7-3-5050	HCPK3
50	35	90P10	CC7-4-5035	HCPK4	CC7-3-5035	HCPK3
50	25	65P10	CC7-4-5025	HCPK4	CC7-3-5025	HCPK3
Ø 10	Ø 10	115P10	CC7-4-1010SC	HCPK4	CC7-3-1010SC	HCPK3
70	70	115P10	CC7-4-7070	HCPK4	CC7-3-7070	HCPK3
70	50	115P10	CC7-4-7050	HCPK4	CC7-3-7050	HCPK3
70	35	90P10	CC7-4-7035	HCPK4	CC7-3-7035	HCPK3
70	25	90P10	CC7-4-7025	HCPK4	CC7-3-7025	HCPK3
95	95	150P10	CC7-4-9595	HCPK4	—	—
95	70	115P10	CC7-4-9570	HCPK4	CC7-3-9570	HCPK3
95	50	115P10	CC7-4-9550	HCPK4	CC7-3-9550	HCPK3
95	35	115P10	CC7-4-9535	HCPK4	CC7-3-9535	HCPK3
120	120	200P10	CC7-4-120120	HCPK4	—	—
120	95	200P10	CC7-4-12095	HCPK4	—	—
120	70	150P10	CC7-4-12070	HCPK4	—	—
120	50	150P10	CC7-4-12050	HCPK4	—	—
150	150	2 x 150P10	CC7-5-150150	HCPK5	—	—
150	120	250P10	CC7-4-150120	HCPK4	—	—
150	95	200P10	CC7-4-15095	HCPK4	—	—
150	70	150P10	CC7-4-15070	HCPK4	—	—
185	185	2 x 150P10	CC7-5-185185	HCPK5	—	—
185	150	2 x 150P10	CC7-5-185150	HCPK5	—	—
185	120	250P10	CC7-4-185120	HCPK4	—	—
185	95	200P10	CC7-4-18595	HCPK4	—	—
240	240	2 x 200P10	CC7-5-240240	HCPK5	—	—
240	185	2 x 200P10	CC7-5-240185	HCPK5	—	—
240	150	2 x 150P10	CC7-5-240150	HCPK5	—	—
240	120	250P10	CC7-4-240120	HCPK4	—	—
300	300	2 x 250P10	CC7-5-300300	HCPK5	—	—
300	240	2 x 250P10	CC7-5-300240	HCPK5	—	—
300	185	2 x 200P10	CC7-5-300185	HCPK5	—	—
300	150	2 x 150P10	CC7-5-300150	HCPK5	—	—

Special moulds for all FurseWELD products can be manufactured to meet specific customer applications on request

*4 x S103 Sleeve required when joining conductors 16 mm² or smaller

FurseWELD

Cable to cable CC11

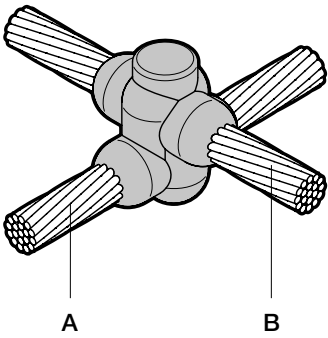

Cable to cable CC11 - FurseWELD

Stranded / solid circular conductor size A (mm ²)	Stranded / solid circular conductor size B (mm ²)	Part no.		
		Powder cartridge	Standard mould	Handle clamp
50	50	150P10	CC11-7-5050	HCPK7
70	70	200P10	CC11-7-7070	HCPK7
95	95	250P10	CC11-7-9595	HCPK7
120	120	2 x 150P10	CC11-7-120120	HCPK7
150	150	2 x 200P10	CC11-8-150150	HCPK8
185	185	2 x 250P10	CC11-8-185185	HCPK8
240	240	3 x 200P10	CC11-8-240240	HCPK8
300	300	3 x 250P10	CC11-8-300300	HCPK8
Ø 8	Ø 8	150P10	CC11-7-8SC8SC	HCPK7
Ø 10	Ø 10	150P10	CC11-7-1010SC	HCPK7

Special moulds for all FurseWELD products can be manufactured to meet specific customer applications on request

FurseWELD

Cable to cable CC14

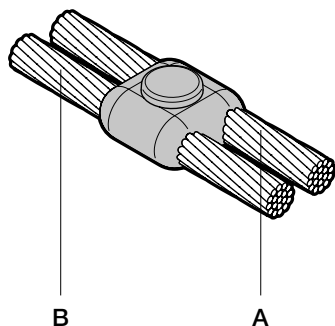

Cable to cable CC14 - FurseWELD

Stranded / solid circular conductor size A (mm ²)	Stranded / solid circular conductor size B (mm ²)	Part no.				
		Powder cartridge	Standard mould	Handle clamp	Mini mould	Mini handle clamp
16 *	16 *	65P10	CC14-4-1616	HCPK4	CC14-3-1616	HCPK3
25	25	45P10	CC14-4-2525	HCPK4	CC14-3-2525	HCPK3
35	35	65P10	CC14-4-3535	HCPK4	CC14-3-3535	HCPK3
35	25	65P10	CC14-4-3525	HCPK4	CC14-3-3525	HCPK3
Ø 8	Ø 8	90P10	CC14-4-88SC	HCPK4	CC14-3-88SC	HCPK3
50	50	90P10	CC14-4-5050	HCPK4	CC14-3-5050	HCPK3
50	35	90P10	CC14-4-5035	HCPK4	CC14-3-5035	HCPK3
50	25	90P10	CC14-4-5025	HCPK4	CC14-3-5025	HCPK3
Ø 10	Ø 10	115P10	CC14-4-1010SC	HCPK4	CC14-3-1010SC	HCPK3
70	70	115P10	CC14-4-7070	HCPK4	CC14-3-7070	HCPK3
70	50	115P10	CC14-4-7050	HCPK4	CC14-3-7050	HCPK3
70	35	90P10	CC14-4-7035	HCPK4	CC14-3-7035	HCPK3
70	25	90P10	CC14-4-7025	HCPK4	CC14-3-7025	HCPK3
95	95	150P10	CC14-4-9595	HCPK4	—	—
95	70	150P10	CC14-4-9570	HCPK4	—	—
95	50	150P10	CC14-4-9550	HCPK4	—	—
95	35	115P10	CC14-4-9535	HCPK4	CC14-3-9535	HCPK3
120	120	200P10	CC14-4-120120	HCPK4	—	—
120	95	200P10	CC14-4-12095	HCPK4	—	—
120	70	200P10	CC14-4-12070	HCPK4	—	—
120	50	150P10	CC14-4-12050	HCPK4	—	—

Special moulds for all FurseWELD products can be manufactured to meet specific customer applications on request
 *4 x S103 Sleeve required when joining conductors 16 mm² or smaller

FurseWELD

Cable to earth rod CR1

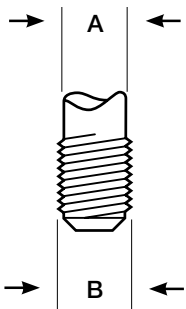
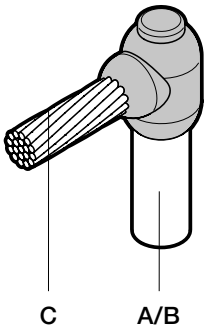

Cable to earth rod CR1 - FurseWELD

Earth rod A ø (mm)	Earth rod B ø (")	Stranded/ solid circular conductor size C (mm ²)	Part no.				
			Powder cartridge	Standard mould	Handle clamp	Mini mould	Mini handle clamp
12.7	½	16 *	65P10	CR1-4-12716	HCPK4	CR1-3-12716	HCPK3
12.7	½	25	65P10	CR1-4-12725	HCPK4	CR1-3-12725	HCPK3
12.7	½	35	65P10	CR1-4-12735	HCPK4	CR1-3-12735	HCPK3
12.7	½	50	65P10	CR1-4-12750	HCPK4	CR1-3-12750	HCPK3
12.7	½	Ø 8	65P10	CR1-4-1278SC	HCPK4	CR1-3-1278SC	HCPK3
12.7	½	70	90P10	CR1-4-12770	HCPK4	CR1-3-12770	HCPK3
12.7	½	95	90P10	CR1-4-12795	HCPK4	CR1-3-12795	HCPK3
12.7	½	120	90P10	CR1-4-127120	HCPK4	CR1-3-127120	HCPK3
14.2	¾	16 *	65P10	CR1-4-14216	HCPK4	CR1-3-14216	HCPK3
14.2	¾	25	65P10	CR1-4-14225	HCPK4	CR1-3-14225	HCPK3
14.2	¾	35	65P10	CR1-4-14235	HCPK4	CR1-3-14235	HCPK3
14.2	¾	50	90P10	CR1-4-14250	HCPK4	CR1-3-14250	HCPK3
14.2	¾	Ø 8	90P10	CR1-4-1428SC	HCPK4	CR1-3-1428SC	HCPK3
14.2	¾	70	90P10	CR1-4-14270	HCPK4	CR1-3-14270	HCPK3
14.2	¾	95	90P10	CR1-4-14295	HCPK4	CR1-3-14295	HCPK3
14.2	¾	120	90P10	CR1-4-142120	HCPK4	CR1-3-142120	HCPK3
14.2	¾	150	115P10	CR1-4-142150	HCPK4	CR1-3-142150	HCPK3
14.2	¾	185	115P10	CR1-4-142185	HCPK4	CR1-3-142185	HCPK3
14.2	¾	240	150P10	CR1-4-142240	HCPK4	-	-
17.2	¾	16 *	65P10	CR1-4-17216	HCPK4	CR1-3-17216	HCPK3
17.2	¾	25	65P10	CR1-4-17225	HCPK4	CR1-3-17225	HCPK3
17.2	¾	35	65P10	CR1-4-17235	HCPK4	CR1-3-17235	HCPK3
17.2	¾	50	90P10	CR1-4-17250	HCPK4	CR1-3-17250	HCPK3
17.2	¾	Ø 8	90P10	CR1-4-1728SC	HCPK4	CR1-3-1728SC	HCPK3
17.2	¾	70	90P10	CR1-4-17270	HCPK4	CR1-3-17270	HCPK3
17.2	¾	95	90P10	CR1-4-17295	HCPK4	CR1-3-17295	HCPK3
17.2	¾	120	90P10	CR1-4-172120	HCPK4	CR1-3-172120	HCPK3
17.2	¾	150	115P10	CR1-4-172150	HCPK4	CR1-3-172150	HCPK3
17.2	¾	185	115P10	CR1-4-172185	HCPK4	CR1-3-172185	HCPK3
17.2	¾	240	150P10	CR1-4-172240	HCPK4	-	-
17.2	¾	300	200P10	CR1-4-172300	HCPK4	-	-

Suitable for connections to copperbond rods - for connections to solid copper and stainless steel rods please contact our sales office
Threaded portion of copperbond rods must be removed prior to welding

Special moulds for all FurseWELD products can be manufactured to meet specific customer applications on request

*1 x S103 Sleeve required when joining conductors 16 mm² or smaller

FurseWELD

Cable to earth rod CR2

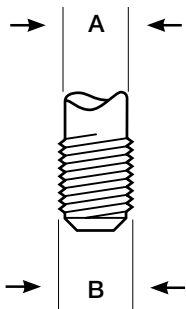
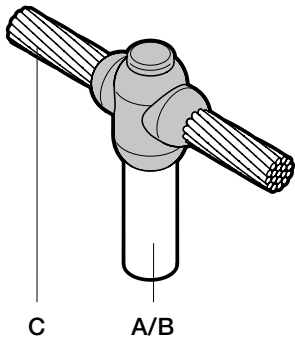

Cable to earth rod CR2 - FurseWELD

Earth rod A Ø (mm)	Earth rod B Ø (")	Stranded/ solid circular conductor size C (mm ²)	Part no.				
			Powder cartridge	Standard mould	Handle clamp	Mini mould	Mini handle clamp
12.7	½	16 *	90P10	CR2-4-12716	HCPK4	CR2-3-12716	HCPK3
12.7	½	25	90P10	CR2-4-12725	HCPK4	CR2-3-12725	HCPK3
12.7	½	35	90P10	CR2-4-12735	HCPK4	CR2-3-12735	HCPK3
12.7	½	50	90P10	CR2-4-12750	HCPK4	CR2-3-12750	HCPK3
12.7	½	Ø 8	90P10	CR2-4-1278SC	HCPK4	CR2-3-1278SC	HCPK3
12.7	½	70	90P10	CR2-4-12770	HCPK4	CR2-3-12770	HCPK3
12.7	½	95	115P10	CR2-4-12795	HCPK4	CR2-3-12795	HCPK3
12.7	½	120	150P10	CR2-4-127120	HCPK4	-	-
14.2	¾	16 *	90P10	CR2-4-14216	HCPK4	CR2-3-14216	HCPK3
14.2	¾	25	90P10	CR2-4-14225	HCPK4	CR2-3-14225	HCPK3
14.2	¾	35	90P10	CR2-4-14235	HCPK4	CR2-3-14235	HCPK3
14.2	¾	50	90P10	CR2-4-14250	HCPK4	CR2-3-14250	HCPK3
14.2	¾	Ø 8	90P10	CR2-4-1428SC	HCPK4	CR2-3-1428SC	HCPK3
14.2	¾	70	115P10	CR2-4-14270	HCPK4	CR2-3-14270	HCPK3
14.2	¾	95	115P10	CR2-4-14295	HCPK4	CR2-3-14295	HCPK3
14.2	¾	120	150P10	CR2-4-142120	HCPK4	-	-
14.2	¾	150	200P10	CR2-4-142150	HCPK4	-	-
14.2	¾	185	200P10	CR2-4-142185	HCPK4	-	-
14.2	¾	240	250P10	CR2-4-142240	HCPK4	-	-
17.2	¾	16 *	90P10	CR2-4-17216	HCPK4	CR2-3-17216	HCPK3
17.2	¾	25	90P10	CR2-4-17225	HCPK4	CR2-3-17225	HCPK3
17.2	¾	35	90P10	CR2-4-17235	HCPK4	CR2-3-17235	HCPK3
17.2	¾	50	115P10	CR2-4-17250	HCPK4	CR2-3-17250	HCPK3
17.2	¾	Ø 8	115P10	CR2-4-1728SC	HCPK4	CR2-3-1728SC	HCPK3
17.2	¾	70	115P10	CR2-4-17270	HCPK4	CR2-3-17270	HCPK3
17.2	¾	95	115P10	CR2-4-17295	HCPK4	CR2-3-17295	HCPK3
17.2	¾	120	150P10	CR2-4-172120	HCPK4	-	-
17.2	¾	150	200P10	CR2-4-172150	HCPK4	-	-
17.2	¾	185	200P10	CR2-4-172185	HCPK4	-	-
17.2	¾	240	250P10	CR2-4-172240	HCPK4	-	-
17.2	¾	300	2 x 150P10	CR2-5-172300	HCPK5	-	-

Suitable for connections to copperbond rods - for connections to solid copper and stainless steel rods please contact our sales office
Threaded portion of copperbond rods must be removed prior to welding

Special moulds for all FurseWELD products can be manufactured to meet specific customer applications on request

*2 x S103 Sleeve required when joining conductors 16 mm² or smaller

FurseWELD

Cable to earth rod CR3

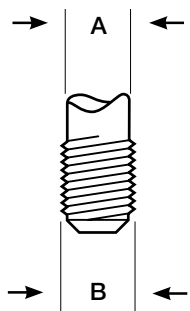
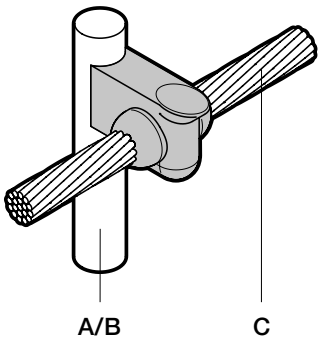

Cable to earth rod CR3 - FurseWELD

Earth rod A ø (mm)	Earth rod B ø (")	Stranded/ solid circular conductor size C (mm ²)	Part no.		
			Powder cartridge	Standard mould	Handle clamp
12.7	½	16 *	90P10	CR3-9-12716	HCPK4
12.7	½	25	90P10	CR3-9-12725	HCPK4
12.7	½	35	90P10	CR3-9-12735	HCPK4
12.7	½	50	115P10	CR3-9-12750	HCPK4
12.7	½	Ø 8	115P10	CR3-9-1278SC	HCPK4
12.7	½	70	115P10	CR3-9-12770	HCPK4
12.7	½	95	115P10	CR3-9-12795	HCPK4
12.7	½	120	150P10	CR3-9-127120	HCPK4
14.2	¾	16 *	90P10	CR3-9-14216	HCPK4
14.2	¾	25	90P10	CR3-9-14225	HCPK4
14.2	¾	35	90P10	CR3-9-14235	HCPK4
14.2	¾	50	115P10	CR3-9-14250	HCPK4
14.2	¾	Ø 8	115P10	CR3-9-1428SC	HCPK4
14.2	¾	70	115P10	CR3-9-14270	HCPK4
14.2	¾	95	115P10	CR3-9-14295	HCPK4
14.2	¾	120	150P10	CR3-9-142120	HCPK4
14.2	¾	150	150P10	CR3-9-142150	HCPK4
14.2	¾	185	200P10	CR3-9-142185	HCPK4
14.2	¾	240	2 x 200P10	CR3-10-142240	HCPK5
17.2	¾	16 *	90P10	CR3-9-17216	HCPK4
17.2	¾	25	90P10	CR3-9-17225	HCPK4
17.2	¾	35	90P10	CR3-9-17235	HCPK4
17.2	¾	50	115P10	CR3-9-17250	HCPK4
17.2	¾	Ø 8	115P10	CR3-9-1728SC	HCPK4
17.2	¾	70	150P10	CR3-9-17270	HCPK4
17.2	¾	95	150P10	CR3-9-17295	HCPK4
17.2	¾	120	200P10	CR3-9-172120	HCPK4
17.2	¾	150	250P10	CR3-9-172150	HCPK4
17.2	¾	185	2 x 200P10	CR3-10-172185	HCPK5
17.2	¾	240	2 x 250P10	CR3-10-172240	HCPK5
17.2	¾	300	3 x 200P10	CR3-10-172300	HCPK5

Suitable for connections to copperbond rods - for connections to solid copper and stainless steel rods please contact our sales office
Threaded portion of copperbond rods must be removed prior to welding

Special moulds for all FurseWELD products can be manufactured to meet specific customer applications on request

*2 x S103 Sleeve required when joining conductors 16 mm² or smaller

Frames

Part no.	Description
F1-FU	Frame for use with Handle Clamp HCPK4
F2-FU	Frame for use with Handle Clamp HCPK5

The CR3 joint type utilizes a 3 part mould. For this reason, a Frame is required in addition to the standard Handle Clamp

FurseWELD

Cable to earth rod CR17

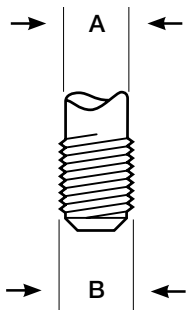
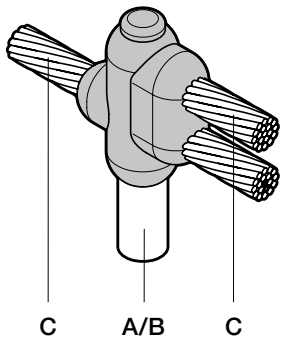

Cable to earth rod CR17 - FurseWELD

Earth rod A ϕ (mm)	Earth rod B ϕ (")	Stranded/ solid circular conductor size C (mm ²)	Part no.				
			Powder cartridge	Standard mould	Handle clamp	Mini mould	Mini handle clamp
12.7	1/2	16 *	90P10	CR17-4-12716	HCPK4	CR17-3-12716	HCPK3
12.7	1/2	25	90P10	CR17-4-12725	HCPK4	CR17-3-12725	HCPK3
12.7	1/2	35	90P10	CR17-4-12735	HCPK4	CR17-3-12735	HCPK3
12.7	1/2	50	115P10	CR17-4-12750	HCPK4	CR17-3-12750	HCPK3
12.7	1/2	\emptyset 8	115P10	CR17-4-1278SC	HCPK4	CR17-3-1278SC	HCPK3
12.7	1/2	70	150P10	CR17-4-12770	HCPK4	-	-
12.7	1/2	95	200P10	CR17-4-12795	HCPK4	-	-
12.7	1/2	120	250P10	CR17-4-127120	HCPK4	-	-
14.2	3/4	16 *	90P10	CR17-4-14216	HCPK4	CR17-3-14216	HCPK3
14.2	3/4	25	90P10	CR17-4-14225	HCPK4	CR17-3-14225	HCPK3
14.2	3/4	35	90P10	CR17-4-14235	HCPK4	CR17-3-14235	HCPK3
14.2	3/4	50	115P10	CR17-4-14250	HCPK4	CR17-3-14250	HCPK3
14.2	3/4	\emptyset 8	115P10	CR17-4-1428SC	HCPK4	CR17-3-1428SC	HCPK3
14.2	3/4	70	200P10	CR17-4-14270	HCPK4	-	-
14.2	3/4	95	250P10	CR17-4-14295	HCPK4	-	-
14.2	3/4	120	250P10	CR17-4-142120	HCPK4	-	-
14.2	3/4	150	250P10	CR17-4-142150	HCPK4	-	-
14.2	3/4	185	2 x 150P10	CR17-4-142185	HCPK4	-	-
14.2	3/4	240	2 x 200P10	CR17-5-142240	HCPK5	-	-
17.2	3/4	16 *	115P10	CR17-4-17216	HCPK4	CR17-3-17216	HCPK3
17.2	3/4	25	115P10	CR17-4-17225	HCPK4	CR17-3-17225	HCPK3
17.2	3/4	35	115P10	CR17-4-17235	HCPK4	CR17-3-17235	HCPK3
17.2	3/4	50	150P10	CR17-4-17250	HCPK4	-	-
17.2	3/4	\emptyset 8	150P10	CR17-4-1728SC	HCPK4	-	-
17.2	3/4	70	200P10	CR17-4-17270	HCPK4	-	-
17.2	3/4	95	250P10	CR17-4-17295	HCPK4	-	-
17.2	3/4	120	250P10	CR17-4-172120	HCPK4	-	-
17.2	3/4	150	2 x 150P10	CR17-4-172150	HCPK4	-	-
17.2	3/4	185	2 x 150P10	CR17-4-172185	HCPK4	-	-
17.2	3/4	240	2 x 200P10	CR17-4-172240	HCPK4	-	-
17.2	3/4	300	2 x 250P10	CR17-5-172240	HCPK5	-	-

Suitable for connections to copperbond rods - for connections to solid copper and stainless steel rods please contact our sales office
Threaded portion of copperbond rods must be removed prior to welding

Special moulds for all FurseWELD products can be manufactured to meet specific customer applications on request

*3 x S103 Sleeve required when joining conductors 16 mm² or smaller

FurseWELD

Cable to earth rod CR24

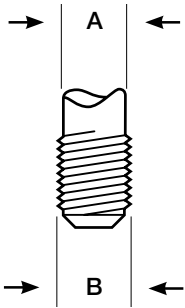
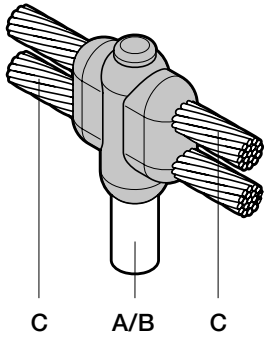

Cable to earth rod CR24 - FurseWELD

Earth rod A ø (mm)	Earth rod B ø (")	Stranded/ solid circular conductor size C (mm ²)	Part no.				
			Powder cartridge	Standard mould	Handle clamp	Mini mould	Mini handle clamp
12.7	½	16 *	90P10	CR24-4-12716	HCPK4	CR24-3-12716	HCPK3
12.7	½	25	90P10	CR24-4-12725	HCPK4	CR24-3-12725	HCPK3
12.7	½	35	90P10	CR24-4-12735	HCPK4	CR24-3-12735	HCPK3
12.7	½	50	115P10	CR24-4-12750	HCPK4	CR24-3-12750	HCPK3
12.7	½	Ø 8	115P10	CR24-4-1278SC	HCPK4	CR24-3-1278SC	HCPK3
12.7	½	70	150P10	CR24-4-12770	HCPK4	-	-
12.7	½	95	200P10	CR24-4-12795	HCPK4	-	-
12.7	½	120	250P10	CR24-4-127120	HCPK4	-	-
14.2	¾	16 *	115P10	CR24-4-14216	HCPK4	CR24-3-14216	HCPK3
14.2	¾	25	115P10	CR24-4-14225	HCPK4	CR24-3-14225	HCPK3
14.2	¾	35	115P10	CR24-4-14235	HCPK4	CR24-3-14235	HCPK3
14.2	¾	50	200P10	CR24-4-14250	HCPK4	-	-
14.2	¾	Ø 8	200P10	CR24-4-1428SC	HCPK4	-	-
14.2	¾	70	250P10	CR24-4-14270	HCPK4	-	-
14.2	¾	95	250P10	CR24-4-14295	HCPK4	-	-
14.2	¾	120	2 x 150P10	CR24-4-142120	HCPK4	-	-
14.2	¾	150	2 x 150P10	CR24-4-142150	HCPK4	-	-
14.2	¾	185	2 x 200P10	CR24-5-142185	HCPK5	-	-
14.2	¾	240	2 x 200P10	CR24-5-142240	HCPK5	-	-
17.2	¾	16 *	115P10	CR24-4-17216	HCPK4	CR24-3-17216	HCPK3
17.2	¾	25	115P10	CR24-4-17225	HCPK4	CR24-3-17225	HCPK3
17.2	¾	35	115P10	CR24-4-17235	HCPK4	CR24-3-17235	HCPK3
17.2	¾	50	250P10	CR24-4-17250	HCPK4	-	-
17.2	¾	Ø 8	250P10	CR24-4-1728SC	HCPK4	-	-
17.2	¾	70	2 x 150P10	CR24-4-17270	HCPK4	-	-
17.2	¾	95	2 x 150P10	CR24-4-17295	HCPK4	-	-
17.2	¾	120	2 x 150P10	CR24-4-172120	HCPK4	-	-
17.2	¾	150	2 x 200P10	CR24-5-172150	HCPK5	-	-
17.2	¾	185	2 x 200P10	CR24-5-172185	HCPK5	-	-
17.2	¾	240	2 x 250P10	CR24-5-172240	HCPK5	-	-
17.2	¾	300	2 x 250P10	CR24-5-172300	HCPK5	-	-

Suitable for connections to copperbond rods - for connections to solid copper and stainless steel rods please contact our sales office
Threaded portion of copperbond rods must be removed prior to welding

Special moulds for all FurseWELD products can be manufactured to meet specific customer applications on request

*4 x S103 Sleeve required when joining conductors 16 mm² or smaller

FurseWELD

Cable to reinforcing bar CRE1

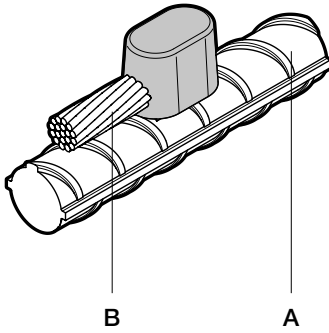

Cable to reinforcing bar CRE1 - FurseWELD

Reinforcing bar size A ø (mm ²)	Stranded/ solid circular conductor size B (mm)	Part no.			
		Powder cartridge	Standard mould	Handle clamp	Packing
10-40	16 *	45P10	CRE1-3-16	HCPK3-B	PACK-A
10-40	25	45P10	CRE1-3-25	HCPK3-B	PACK-A
10-40	35	45P10	CRE1-3-35	HCPK3-B	PACK-A
10-40	Ø 8	90P10	CRE1-3-8SC	HCPK3-B	PACK-A
10-40	50	90P10	CRE1-3-50	HCPK3-B	PACK-A
10-40	Ø 10	90P10	CRE1-3-10SC	HCPK3-B	PACK-A
10-40	70	90P10	CRE1-3-70	HCPK3-B	PACK-A
10-40	95	90P10	CRE1-3-95	HCPK3-B	PACK-A
10-40	120	90P10	CRE1-3-120	HCPK3-B	PACK-A

Special moulds for all FurseWELD products can be manufactured to meet specific customer applications on request

*1 x S103 Sleeve required when joining conductors 16 mm² or smaller

FurseWELD

Cable to reinforcing bar CRE2

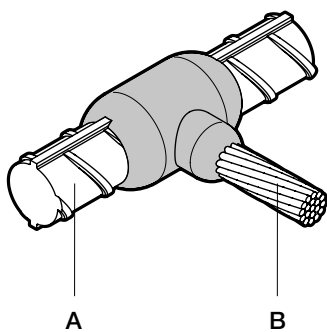

Cable to reinforcing bar CRE2 - FurseWELD

Reinforcing bar size A ø (mm)	Stranded/ solid circular conductor size B (mm ²)	Part no.		
		Powder cartridge	Standard mould	Handle clamp
16	16 *	90P10	CRE2-4-16R16	HCPK4
16	25	90P10	CRE2-4-16R25	HCPK4
16	35	90P10	CRE2-4-16R35	HCPK4
16	Ø 8	115P10	CRE2-4-16R8SC	HCPK4
16	50	115P10	CRE2-4-16R50	HCPK4
16	Ø 10	115P10	CRE2-4-16R10SC	HCPK4
16	70	115P10	CRE2-4-16R70	HCPK4
16	95	150P10	CRE2-4-16R95	HCPK4
16	120	150P10	CRE2-4-16R120	HCPK4
16	150	200P10	CRE2-4-16R150	HCPK4
16	185	200P10	CRE2-4-16R185	HCPK4
16	240	250P10	CRE2-4-16R240	HCPK4
16	300	2 x 150P10	CRE2-4-16R300	HCPK4
18	16 *	115P10	CRE2-4-18R16	HCPK4
18	25	115P10	CRE2-4-18R25	HCPK4
18	35	115P10	CRE2-4-18R35	HCPK4
18	Ø 8	150P10	CRE2-4-18R8SC	HCPK4
18	50	150P10	CRE2-4-18R50	HCPK4
18	Ø 10	150P10	CRE2-4-18R10SC	HCPK4
18	70	150P10	CRE2-4-18R70	HCPK4
18	95	150P10	CRE2-4-18R95	HCPK4
18	120	200P10	CRE2-4-18R120	HCPK4
18	150	200P10	CRE2-4-18R150	HCPK4
18	185	200P10	CRE2-4-18R185	HCPK4
18	240	250P10	CRE2-4-18R240	HCPK4
18	300	2 x 150P10	CRE2-4-18R300	HCPK4
20	16 *	115P10	CRE2-4-20R16	HCPK4
20	25	115P10	CRE2-4-20R25	HCPK4
20	35	115P10	CRE2-4-20R35	HCPK4
20	Ø 8	150P10	CRE2-4-20R8SC	HCPK4
20	50	150P10	CRE2-4-20R50	HCPK4
20	Ø 10	150P10	CRE2-4-20R10SC	HCPK4
20	70	200P10	CRE2-4-20R70	HCPK4
20	95	200P10	CRE2-4-20R95	HCPK4
20	120	200P10	CRE2-4-20R120	HCPK4
20	150	200P10	CRE2-4-20R150	HCPK4
20	185	250P10	CRE2-4-20R185	HCPK4
20	240	2 x 150P10	CRE2-4-20R240	HCPK4
20	300	2 x 200P10	CRE2-5-20R300	HCPK5
25	16 *	200P10	CRE2-4-25R16	HCPK4
25	25	200P10	CRE2-4-25R25	HCPK4
25	35	200P10	CRE2-4-25R35	HCPK4
25	Ø 8	200P10	CRE2-4-25R8SC	HCPK4

Special moulds for all FurseWELD products can be manufactured to meet specific customer applications on request

*1 x S103 Sleeve required when joining conductors 16 mm² or smaller



FurseWELD

Cable to reinforcing bar CRE2 & CRE 3

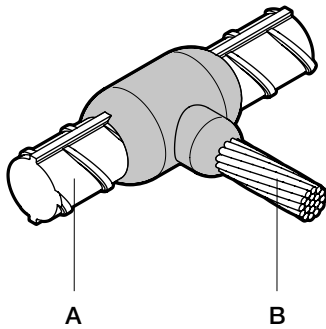

Cable to reinforcing bar CRE2 (continued) - FurseWELD

Reinforcing bar size A ø (mm)	Stranded/ solid circular conductor size B (mm ²)	Part no.		
		Powder cartridge	Standard mould	Handle clamp
25	50	200P10	CRE2-4-25R50	HCPK4
25	Ø 10	250P10	CRE2-4-25R10SC	HCPK4
25	70	250P10	CRE2-4-25R70	HCPK4
25	95	250P10	CRE2-4-25R95	HCPK4
25	120	250P10	CRE2-4-25R120	HCPK4
25	150	2x 150P10	CRE2-4-25R150	HCPK4
25	185	2x 150P10	CRE2-5-25R185	HCPK5
25	240	2x 200P10	CRE2-5-25R240	HCPK5
25	300	2x 200P10	CRE2-5-25R300	HCPK5
30	16 *	250P10	CRE2-4-30R16	HCPK4
30	25	250P10	CRE2-4-30R25	HCPK4
30	35	250P10	CRE2-4-30R35	HCPK4
30	Ø 8	2x 150P10	CRE2-4-30R8SC	HCPK4
30	50	2x 150P10	CRE2-4-30R50	HCPK4
30	Ø 10	2x 150P10	CRE2-4-30R10SC	HCPK4
30	70	2x 150P10	CRE2-4-30R70	HCPK4
30	95	2x 150P10	CRE2-5-30R95	HCPK5
30	120	2x 200P10	CRE2-5-30R120	HCPK5
30	150	2x 200P10	CRE2-5-30R150	HCPK5
30	185	2x 250P10	CRE2-5-30R185	HCPK5
30	240	3x 200P10	CRE2-5-30R240	HCPK5
30	300	3x 200P10	CRE2-5-30R300	HCPK5

Special moulds for all FurseWELD products can be manufactured to meet specific customer applications on request

*1 x S103 Sleeve required when joining conductors 16 mm² or smaller

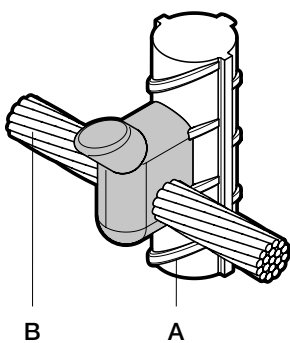

Cable to reinforcing bar CRE3 - FurseWELD

Reinforcing bar size A ø (mm)	Stranded/ solid circular conductor size B (mm ²)	Part no.			
		Powder cartridge	Standard mould	Handle clamp	Packing
10-40	16 *	45P10	CRE3-3-16	HCPK3-A	PACK-A
10-40	25	45P10	CRE3-3-25	HCPK3-A	PACK-A
10-40	35	45P10	CRE3-3-35	HCPK3-A	PACK-A
10-40	Ø 8	90P10	CRE3-3-8SC	HCPK3-A	PACK-A
10-40	50	90P10	CRE3-3-50	HCPK3-A	PACK-A
10-40	Ø 10	90P10	CRE3-3-10SC	HCPK3-A	PACK-A
10-40	70	90P10	CRE3-3-70	HCPK3-A	PACK-A
10-40	95	90P10	CRE3-3-95	HCPK3-A	PACK-A
10-40	120	90P10	CRE3-3-120	HCPK3-A	PACK-A

Special moulds for all FurseWELD products can be manufactured to meet specific customer applications on request

*2 x S103 Sleeve required when joining conductors 16 mm² or smaller

FurseWELD

Cable to reinforcing bar CRE6 & CRE17

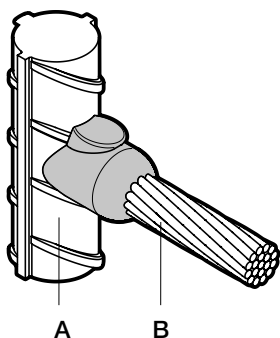

Cable to reinforcing bar CRE6 - FurseWELD

Reinforcing bar size A ø (mm)	Stranded/ solid circular conductor size B (mm ²)	Part no.			
		Powder cartridge	Standard mould	Handle clamp	Packing
10-40	16 *	45P10	CRE6-3-16	HCPK3-A	PACK-A
10-40	25	45P10	CRE6-3-25	HCPK3-A	PACK-A
10-40	35	45P10	CRE6-3-35	HCPK3-A	PACK-A
10-40	Ø 8	65P10	CRE6-3-8SC	HCPK3-A	PACK-A
10-40	50	65P10	CRE6-3-50	HCPK3-A	PACK-A
10-40	Ø 10	90P10	CRE6-3-10SC	HCPK3-A	PACK-A
10-40	70	90P10	CRE6-3-70	HCPK3-A	PACK-A
10-40	95	90P10	CRE6-4-95	HCPK3-A	PACK-A
10-40	120	115P10	CRE6-4-120	HCPK3-A	PACK-A

Special moulds for all FurseWELD products can be manufactured to meet specific customer applications on request
 *1 x S103 Sleeve required when joining conductors 16 mm² or smaller

9

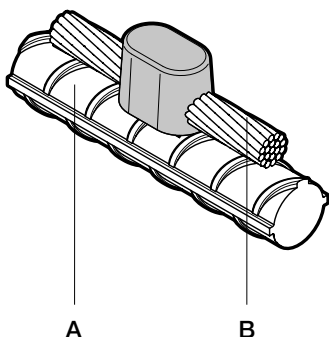

Cable to reinforcing bar CRE17 - FurseWELD

Reinforcing bar size A ø (mm)	Stranded/ solid circular conductor size B (mm ²)	Part no.			
		Powder cartridge	Standard mould	Handle clamp	Packing
10-40	16 *	45P10	CRE17-3-16	HCPK3-B	PACK-A
10-40	25	45P10	CRE17-3-25	HCPK3-B	PACK-A
10-40	35	45P10	CRE17-3-35	HCPK3-B	PACK-A
10-40	Ø 8	90P10	CRE17-3-8SC	HCPK3-B	PACK-A
10-40	50	90P10	CRE17-3-50	HCPK3-B	PACK-A
10-40	Ø 10	90P10	CRE17-3-10SC	HCPK3-B	PACK-A
10-40	70	90P10	CRE17-3-70	HCPK3-B	PACK-A
10-40	95	90P10	CRE17-3-95	HCPK3-B	PACK-A
10-40	120	90P10	CRE17-3-120	HCPK3-B	PACK-A

Special moulds for all FurseWELD products can be manufactured to meet specific customer applications on request
 *1 x S103 Sleeve required when joining conductors 16 mm² or smaller

FurseWELD

Cable to steel surface & pipe CS1 & CS2

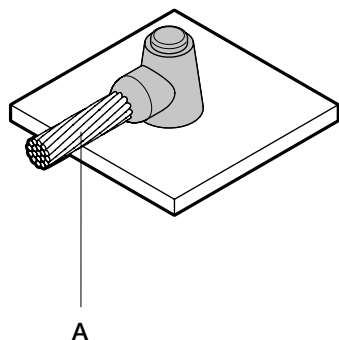

Cable to steel surface & pipe CS1 - FurseWELD

Stranded / solid circular conductor size A (mm ²)	Part no.		
	Powder cartridge	Standard mould	Handle clamp
16	Use CS8		
25	Use CS8		
35	Use CS8		
Ø 8 mm	90P10	CS1-4-8SC	HCPK4
50	90P10	CS1-4-50-FU	HCPK4
Ø 10 mm	90P10	CS1-4-10SC	HCPK4
70	90P10	CS1-4-70	HCPK4
95	115P10	CS1-4-95	HCPK4
120	115P10	CS1-4-120	HCPK4
150	150P10	CS1-4-150	HCPK4
185	200P10	CS1-4-185	HCPK4
240	200P10	CS1-4-240	HCPK4
300	250P10	CS1-4-300	HCPK4

Special moulds for all FurseWELD products can be manufactured to meet specific customer applications on request

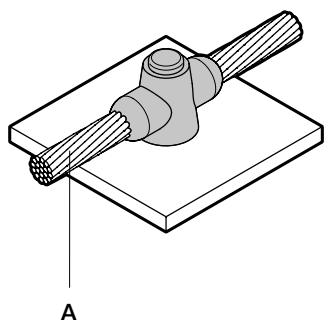

Cable to steel surface & pipe CS2 - FurseWELD

Stranded / solid circular conductor size A (mm ²)	Part no.		
	Powder cartridge	Standard mould	Handle clamp
16	Use CS9		
25	Use CS9		
35	Use CS9		
Ø 8 mm	90P10	CS2-4-8SC	HCPK4
50	90P10	CS2-4-50	HCPK4
Ø 10 mm	115P10	CS2-4-10SC	HCPK4
70	115P10	CS2-4-70	HCPK4
95	115P10	CS2-4-95	HCPK4
120	150P10	CS2-4-120	HCPK4
150	200P10	CS2-4-150	HCPK4
185	250P10	CS2-4-185	HCPK4
240	2 x 150P10	CS2-5-240	HCPK5
300	2 x 200P10	CS2-5-300	HCPK5

Special moulds for all FurseWELD products can be manufactured to meet specific customer applications on request

FurseWELD

Cable to steel surface & pipe CS3 & CS7

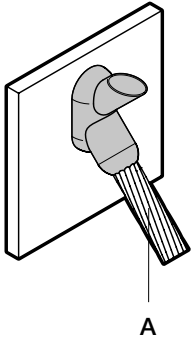

Cable to steel surface & pipe CS3 - FurseWELD

Stranded / solid circular conductor size A (mm ²)	Part no.				
	Powder cartridge	Standard mould	Handle clamp	Mini mould	Mini handle clamp
16 *	45P10	CS3-4-16	HCPK4	CS3-3-16	HCPK3
25	45P10	CS3-4-25	HCPK4	CS3-3-25	HCPK3
35	45P10	CS3-4-35	HCPK4	CS3-3-35	HCPK3
Ø 8	65P10	CS3-4-8SC	HCPK4	CS3-3-8SC	HCPK3
50	65P10	CS3-4-50	HCPK4	CS3-3-50	HCPK3
Ø 10 m	90P10	CS3-4-10SC	HCPK4	CS3-3-10SC	HCPK3
70	90P10	CS3-4-70	HCPK4	CS3-3-70	HCPK3
95	115P10	CS3-4-95	HCPK4	CS3-3-95	HCPK3
120	115P10	CS3-4-120	HCPK4	CS3-3-120	HCPK3
150	115P10	CS3-4-150	HCPK4	CS3-3-150	HCPK3
185	200P10	CS3-4-185	HCPK4	-	-
240	200P10	CS3-4-240	HCPK4	-	-
300	250P10	CS3-4-300	HCPK4	-	-

Special moulds for all FurseWELD products can be manufactured to meet specific customer applications on request

*1 x S103 Sleeve required when joining conductors 16 mm² or smaller

9

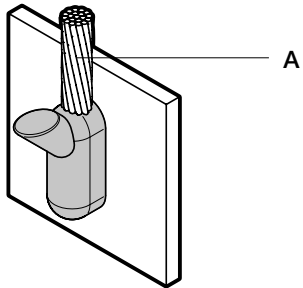

Cable to steel surface & pipe CS7 - FurseWELD

Stranded / solid circular conductor size A (mm ²)	Part no.				
	Powder cartridge	Standard mould	Handle clamp	Mini mould	Mini handle clamp
16 *	65P10	CS7-4-16	HCPK4	CS7-3-16	HCPK3
25	65P10	CS7-4-25	HCPK4	CS7-3-25	HCPK3
35	65P10	CS7-4-35	HCPK4	CS7-3-35	HCPK3
Ø 8	90P10	CS7-4-8SC	HCPK4	CS7-3-8SC	HCPK3
50	90P10	CS7-4-50	HCPK4	CS7-3-50	HCPK3
Ø 10	150P10	CS7-4-10SC	HCPK4	-	-
70	150P10	CS7-4-70	HCPK4	-	-
95	200P10	CS7-5-95	HCPK4	-	-
120	200P10	CS7-5-120	HCPK4	-	-
150	250P10	CS7-5-150	HCPK4	-	-
185	2 x 150P10	CS7-9-185	HCPK4	-	-
240	2 x 150P10	CS7-9-240	HCPK4	-	-
300	2 x 200P10	CS7-10-300	HCPK5	-	-

Special moulds for all FurseWELD products can be manufactured to meet specific customer applications on request

*1 x S103 Sleeve required when joining conductors 16 mm² or smaller

FurseWELD

Cable to steel surface & pipe CS8 & CS9

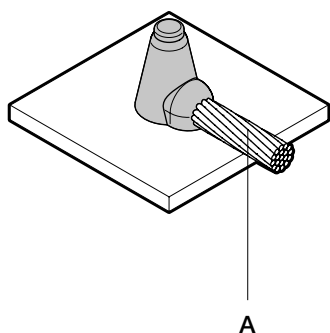

Cable to steel surface & pipe CS8 - FurseWELD

Stranded / solid circular conductor size A (mm ²)	Part no.		
	Powder cartridge	Standard mould	Handle clamp
16 *	45P10	CS8-2-16	HCPK2
25	45P10	CS8-2-25	HCPK2
35	45P10	CS8-2-35	HCPK2
Ø 8	45P10	CS8-2-8SC	HCPK2
50	45P10	CS8-2-50	HCPK2
Ø 10	65P10	CS8-2-10SC	HCPK2
70	65P10	CS8-2-70	HCPK2
95	90P10	CS8-2-95	HCPK2
120	115P10	CS8-4-120	HCPK4
150	150P10	CS8-4-150	HCPK4
185	200P10	CS8-4-185	HCPK4
240	200P10	CS8-4-240	HCPK4
300	250P10	CS8-4-300	HCPK4

Special moulds for all FurseWELD products can be manufactured to meet specific customer applications on request
 *1 x S103 Sleeve required when joining conductors 16 mm² or smaller

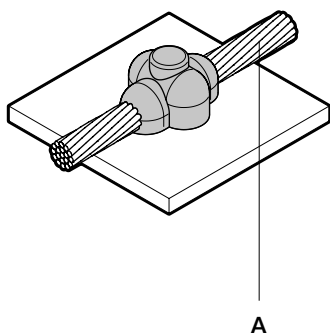

Cable to steel surface & pipe CS9 - FurseWELD

Stranded / solid circular conductor size A (mm ²)	Part no.		
	Powder cartridge	Standard mould	Handle clamp
16 *	45P10	CS9-4-16	HCPK2
25	45P10	CS9-4-25	HCPK2
35	45P10	CS9-4-35	HCPK2
Ø 8	90P10	CS9-4-8SC	HCPK4
50	90P10	CS9-4-50	HCPK4
Ø 10	115P10	CS9-4-10SC	HCPK4
70	115P10	CS9-4-70	HCPK4
95	115P10	C9-4-95	HCPK4
120	150P10	CS9-4-120	HCPK4
150	200P10	CS9-4-150	HCPK4
185	250P10	CS9-4-185	HCPK4
240	2 x 150P10	CS9-5-240	HCPK5

Special moulds for all FurseWELD products can be manufactured to meet specific customer applications on request
 *1 x S103 Sleeve required when joining conductors 16 mm² or smaller



FurseWELD

Cable to steel surface & pipe CS25 & CS27

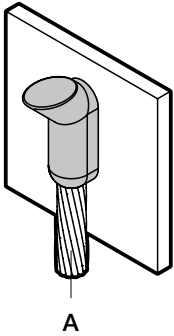

Cable to steel surface & pipe CS25 - FurseWELD

Stranded / solid circular conductor size A (mm ²)	Part no.				
	Powder cartridge	Standard mould	Handle clamp	Mini mould	Mini handle clamp
16 *	45P10	CS25-4-16	HCPK4	CS25-3-16	HCPK3
25	45P10	CS25-4-25	HCPK4	CS25-3-25	HCPK3
35	45P10	CS25-4-35	HCPK4	CS25-3-35	HCPK3
Ø 8	65P10	CS25-4-8SC	HCPK4	CS25-3-8SC	HCPK3
50	65P10	CS25-4-50	HCPK4	CS25-3-50	HCPK3
Ø 10	90P10	CS25-4-10SC	HCPK4	-	-
70	90P10	CS25-4-70	HCPK4	CS25-3-70	HCPK3
95	115P10	CS25-4-95	HCPK4	-	-
120	115P10	CS25-4-120	HCPK4	-	-
150	150P10	CS25-4-150	HCPK4	-	-
185	200P10	CS25-4-185	HCPK4	-	-
240	200P10	CS25-4-240	HCPK4	-	-
300	250P10	CS25-4-300	HCPK4	-	-

Special moulds for all FurseWELD products can be manufactured to meet specific customer applications on request

*1 x S103 Sleeve required when joining conductors 16 mm² or smaller



9

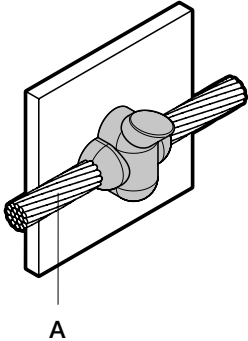

Cable to steel surface & pipe CS27 - FurseWELD

Stranded / solid circular conductor size A (mm ²)	Part no.		
	Powder cartridge	Standard mould	Handle clamp
16 *	45P10	CS27-4-16	HCPK4
25	45P10	CS27-4-25	HCPK4
35	45P10	CS27-4-35	HCPK4
Ø 8	65P10	CS27-4-8SC	HCPK4
50	65P10	CS27-4-50	HCPK4
Ø 10	115P10	CS27-4-10SC	HCPK4
70	115P10	CS27-4-70	HCPK4
95	150P10	CS27-4-95	HCPK4
120	150P10	CS27-4-120	HCPK4
150	200P10	CS27-5-150	HCPK5
185	250P10	CS27-5-185	HCPK5
240	2 x 150P10	CS27-5-240	HCPK5
300	2 x 200P10	CS27-5-300	HCPK5

Special moulds for all FurseWELD products can be manufactured to meet specific customer applications on request

*1 x S103 Sleeve required when joining conductors 16 mm² or smaller



FurseWELD

Cable to steel surface & pipe CS32

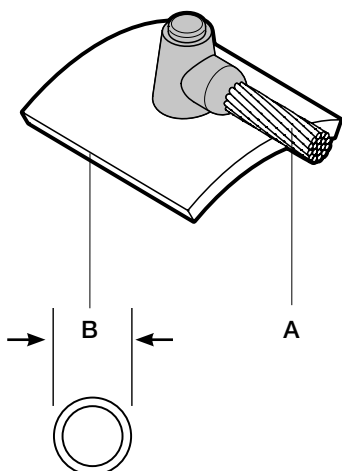

Cable to steel surface & pipe CS32 - FurseWELD

Stranded conductor size A (mm ²)	Pipe size B ø (mm)	Part no.			
		Powder cartridge	Standard mould	Handle clamp	Sleeve
2.5	< 125	15P10	CS32-1-2.5-A	HCPK1	1 x S105
2.5	> 125	15P10	CS32-1-2.5-B	HCPK1	1 x S105
4	< 125	15P10	CS32-1-4-A	HCPK1	1 x S105
4	> 125	15P10	CS32-1-4-B	HCPK1	1 x S105
6	< 125	15P10	CS32-1-6-A	HCPK1	1 x S105
6	> 125	15P10	CS32-1-6-B	HCPK1	1 x S105
10	< 125	25P10	CS32-1-10-A	HCPK1	1 x S102
10	> 125	25P10	CS32-1-10-B	HCPK1	1 x S102
16	< 125	45P10	CS32-2-16-A	HCPK2	1 x S103
16	> 125	45P10	CS32-2-16-B	HCPK2	1 x S103
25	< 70	25P10	CS32-1-25-C	HCPK1	-
25	70-165	25P10	CS32-1-25-D	HCPK1	-
25	> 165	25P10	CS32-1-25-E	HCPK1	-
35	< 70	45P10	CS32-2-35-C	HCPK2	-
35	70-165	45P10	CS32-2-35-D	HCPK2	-
35	165-250	45P10	CS32-2-35-F	HCPK2	-
35	> 250	45P10	CS32-2-35-G	HCPK2	-
50	< 70	45P10	CS32-2-50-C	HCPK2	-
50	70-165	45P10	CS32-2-50-D	HCPK2	-
50	165-250	45P10	CS32-2-50-F	HCPK2	-
50	> 250	45P10	CS32-2-50-G	HCPK2	-
70	< 70	65P10	CS32-2-70-C	HCPK2	-
70	70-165	65P10	CS32-2-70-D	HCPK2	-
70	165-250	65P10	CS32-2-70-F	HCPK2	-
70	> 250	65P10	CS32-2-70-G	HCPK2	-

Special moulds for all FurseWELD products can be manufactured to meet specific customer applications on request



FurseWELD

Cable to steel surface & pipe CS34

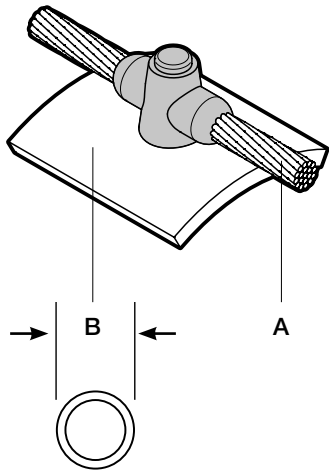

Cable to steel surface & pipe CS34 - FurseWELD

Stranded conductor size A (mm ²)	Pipe size B ø (mm)	Part no.			
		Powder cartridge	Standard mould	Handle clamp	Sleeve
2.5	< 125	15P10	CS34-2-2.5-A	HCPK2	2 x S105
2.5	> 125	15P10	CS34-2-2.5-B	HCPK2	2 x S105
4	< 125	15P10	CS34-2-4-A	HCPK2	2 x S105
4	> 125	15P10	CS34-2-4-B	HCPK2	2 x S105
6	< 125	15P10	CS34-2-6-A	HCPK2	2 x S105
6	> 125	15P10	CS34-2-6-B	HCPK2	2 x S105
10	< 125	32P10	CS34-2-10-A	HCPK2	2 x S102
10	> 125	32P10	CS34-2-10-B	HCPK2	2 x S102
16	< 125	45P10	CS34-2-16-A	HCPK2	2 x S103
16	> 125	45P10	CS34-2-16-B	HCPK2	2 x S103
25	< 70	32P10	CS34-2-25-C	HCPK2	-
25	70-165	32P10	CS34-2-25-D	HCPK2	-
25	> 165	32P10	CS34-2-25-E	HCPK2	-
35	< 70	45P10	CS34-2-35-C	HCPK2	-
35	70-165	45P10	CS34-2-35-D	HCPK2	-
35	165-250	45P10	CS34-2-35-F	HCPK2	-
35	> 250	45P10	CS34-2-35-G	HCPK2	-
50	< 70	65P10	CS34-2-50-C	HCPK2	-
50	70-165	65P10	CS34-2-50-D	HCPK2	-
50	165-250	65P10	CS34-2-50-F	HCPK2	-
50	> 250	65P10	CS34-2-50-G	HCPK2	-

Special moulds for all FurseWELD products can be manufactured to meet specific customer applications on request



FurseWELD

Stud to steel surface RS1 & RS2

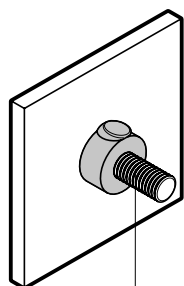

A

Stud to steel surface RS1 - FurseWELD

Stud size A	Part no.			
	Powder cartridge	Standard mould	Handle clamp	Stud
M6	25P10	RS1-4-M6	HCPK4	RSSM6
M8	32P10	RS1-4-M8	HCPK4	RSSM8
M10	45P10	RS1-4-M10	HCPK4	RSSM10
M12	65P10	RS1-4-M12	HCPK4	RSSM12
M16	115P10	RS1-4-M16	HCPK4	RSSM16

Special moulds for all FurseWELD products can be manufactured to meet specific customer applications on request

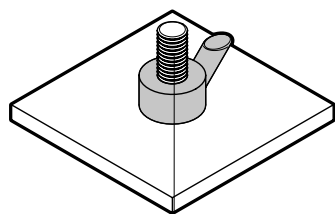

A

Stud to steel surface RS2 - FurseWELD

Stud Size A	Part no.			
	Powder cartridge	Standard mould	Handle clamp	Stud
M6	25P10	RS2-4-M6	HCPK4	RSSM6
M8	32P10	RS2-4-M8	HCPK4	RSSM8
M10	45P10	RS2-4-M10	HCPK4	RSSM10
M12	65P10	RS2-4-M12	HCPK4	RSSM12
M16	115P10	RS2-5-M16	HCPK5	RSSM16

Special moulds for all FurseWELD products can be manufactured to meet specific customer applications on request

FurseWELD SureSHOT System



The FurseWELD SureSHOT system is a cost effective solution for applications requiring only a small number of high quality electrical connections.

Like all FurseWELD products, SureSHOT uses the high temperature reaction between powdered copper oxide and aluminium to create fault tolerant electrical connections without any external power or heat source.

SureSHOT connections have the same benefits as FurseWELD connections:

- Tolerant to repeated fault currents
- Highly conductive
- Does not loosen
- Excellent corrosion resistance

Unlike the graphite FurseWELD moulds, the SureSHOT moulds are ceramic and specifically designed to be used only once. They are disposed of or buried in place with the joint once it has been completed. SureSHOT moulds are supplied complete with powders and retaining disc.

9

1 Insert the rod and conductor into the mould, locate the retaining disc and pour in the weld powder | 2 Place the lid on top of the mould, add starting powder and ignite with spark gun | 3 The resulting exothermic reaction reduces the weld powder to molten copper alloy which melts the retaining disc and flows into the weld cavity where it partially melts the conductors. The molten copper alloy cools to leave a fusion weld of great mechanical and electrical integrity | 4 Once the joint is completed, the ceramic mould can either be disposed of or buried in place

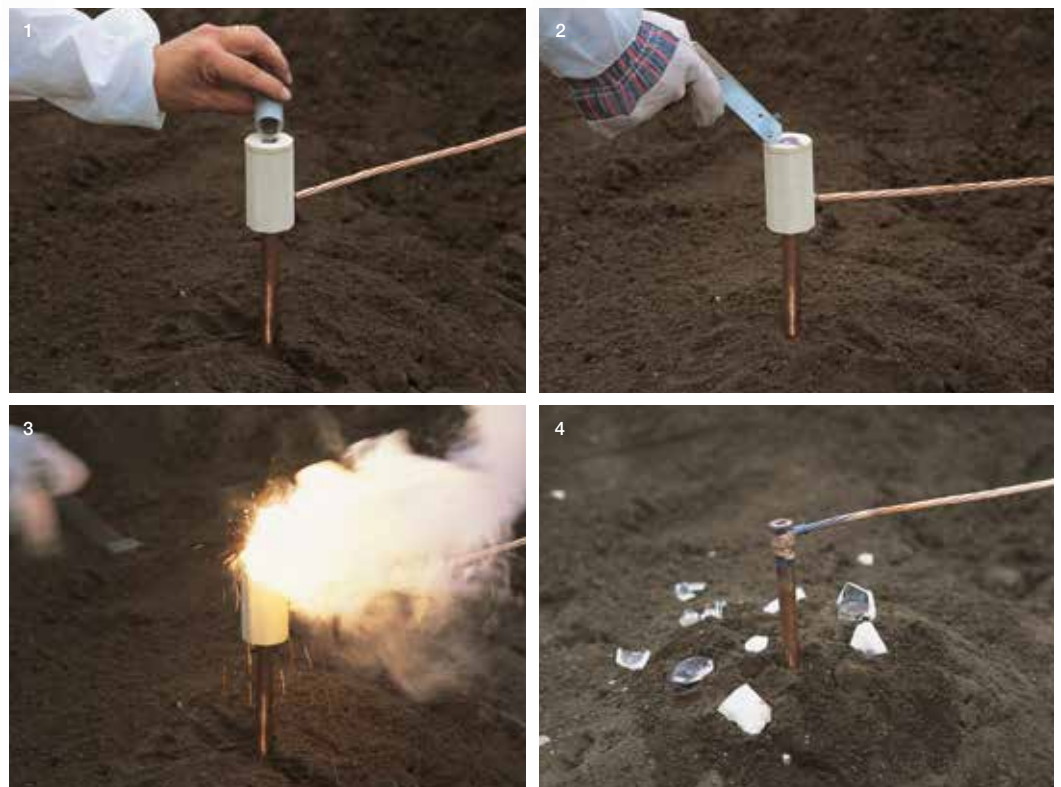

FurseWELD

SureSHOT SS1 & SS2

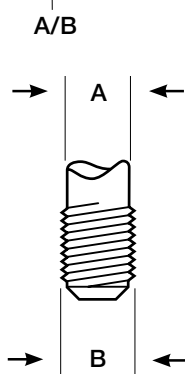
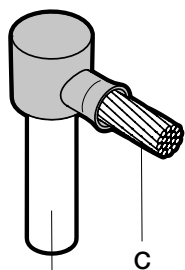

SureSHOT SS1 - FurseWELD

Part no.	A ø (mm)	B ø (")	Stranded conductor C (mm ²)	Pack quantity
SS1-14216	14.2	5/8	16	4
SS1-14225	14.2	5/8	25	4
SS1-14235	14.2	5/8	35	4
SS1-14250	14.2	5/8	50	4
SS1-14270	14.2	5/8	70	4
SS1-14295	14.2	5/8	95	4
SS1-17216	17.2	3/4	16	4
SS1-17225	17.2	3/4	25	4
SS1-17235	17.2	3/4	35	4
SS1-17250	17.2	3/4	50	4
SS1-17270	17.2	3/4	70	4
SS1-17295	17.2	3/4	95	4

Suitable for connections to copperbond rods - for connections to solid copper and stainless steel rods please contact our sales office
Threaded portion of copperbond rods must be removed prior to welding

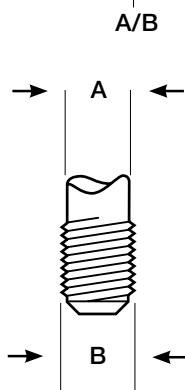
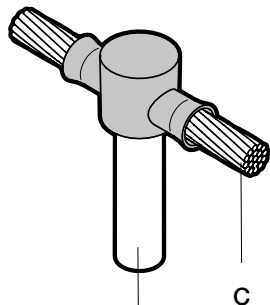

SureSHOT SS2 - FurseWELD

Part no.	A ø (mm)	B ø (")	Stranded conductor C (mm ²)	Pack quantity
SS2-14216	14.2	5/8	16	4
SS2-14225	14.2	5/8	25	4
SS2-14235	14.2	5/8	35	4
SS2-14250	14.2	5/8	50	4
SS2-14270	14.2	5/8	70	4
SS2-14295	14.2	5/8	95	4
SS2-17216	17.2	3/4	16	4
SS2-17225	17.2	3/4	25	4
SS2-17235	17.2	3/4	35	4
SS2-17250	17.2	3/4	50	4
SS2-17270	17.2	3/4	70	4
SS2-17295	17.2	3/4	95	4

Suitable for connections to copperbond rods - for connections to solid copper and stainless steel rods please contact our sales office
Threaded portion of copperbond rods must be removed prior to welding

FurseWELD

Straight type lug & cranked type lug

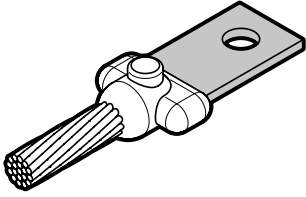

Straight type lug - FurseWELD

Part no.	Stranded Conductor				
	A (mm)	B (mm)	C (mm)	D (mm)	E (mm)
LS101-FU	20	3	45	10	8.5
LS102-FU	25	3	50	12	8.5
LS103-FU	25	3	50	12	10.5
LS104-FU	31	6	75	15	10.5
LS105-FU	31	6	75	15	12.5
LS106-FU	38	5	75	18	10.5
LS107-FU	38	6	75	18	10.5
LS108-FU	38	6	75	20	12.5
LS109-FU	50	6	95	25	10.5
LS110-FU	50	6	95	25	12.5

For suitable FurseWELD connection see page 9/22

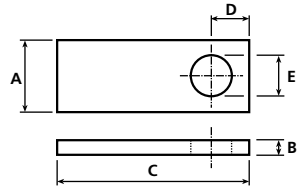

9

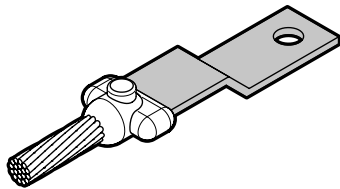

Cranked type lug - FurseWELD

Part no.	Stranded conductor						
	A (mm)	B (mm)	C (mm)	D (mm)	E (mm)	F (mm)	G (mm)
LC101-FU	20	3	40	10	8.5	40	10
LC102-FU	25	3	45	12	8.5	40	10
LC103-FU	25	3	45	12	10.5	40	10
LC104-FU	31	6	50	15	10.5	40	15
LC105-FU	31	6	50	16	12.5	40	15
LC106-FU	38	5	55	18	10.5	40	15
LC107-FU	38	6	55	18	10.5	40	15
LC108-FU	38	6	55	20	12.5	40	15
LC109-FU	50	6	75	25	10.5	60	20
LC110-FU	50	6	75	25	12.5	60	20

For suitable FurseWELD connection see page 9/22

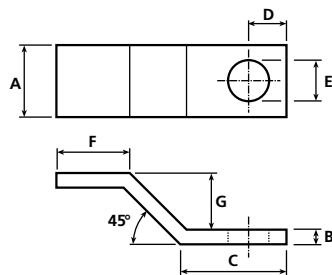

FurseWELD

Offset type lug

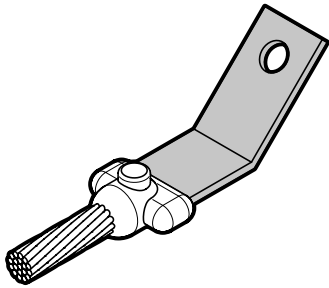

Offset type lug - FurseWELD

Part no.	Stranded conductor					
	A (mm)	B (mm)	C (mm)	D (mm)	E (mm)	F (mm)
LO101	20	3	40	10	8.5	40
LO102-FU	25	3	45	12	8.5	40
LO103-FU	25	3	45	12	10.5	40
LO104	31	6	50	15	10.5	40
LO105	31	6	50	16	12.5	40
LO106	38	5	55	18	10.5	40
LO107	38	6	55	18	10.5	40
LO108	38	6	55	20	12.5	40
LO109	50	6	75	25	10.5	60
LO110	50	6	75	25	12.5	60

For suitable FurseWELD connection see page 9/22

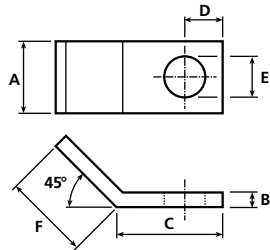

FurseWELD

Handle clamps



Hande clamps - FurseWELD

Part no.	Description
HCPK1	Single part moulds (Price Key 1)
HCPK2	Single part moulds (Price Key 2)
HCPK3	Two part moulds (Price Key 3)
HCPK3A	With chain grip, two part moulds (Price Key 3)
HCPK3B	Sprung, single part moulds (Price Key 3)
HCPK4	Two-part moulds (Price Key 4)
HCPK4A	With chain grip, multi-part moulds (Price Key 4)
HCPK5	Multi-part moulds (Price Key 5)
HCPK7	Multi-part moulds (Price Key 7)
HCPK8	Multi-part moulds (Price Key 8)

Frames

F1-FU	Frame for use with Handle Clamp HCPK4
F2-FU	Frame for use with Handle Clamp HCPK5

Handle clamps with chain grip enable location and fixing of the mould on to uneven surfaces such as pipes and rebars

Note: Drawings for illustration only. Product supplied may vary from illustration shown

HCPK2

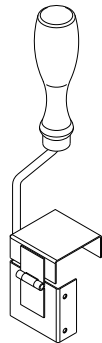

HCPK3

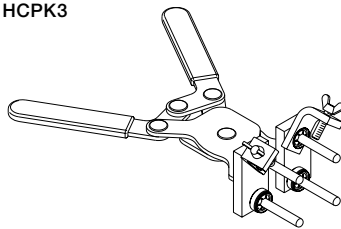

HCPK3A

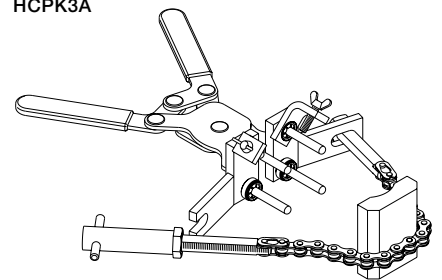

HCPK4 & HCPK5

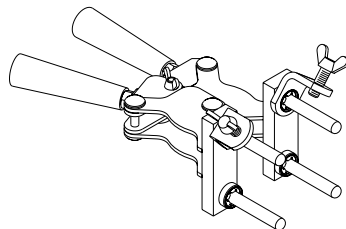

HCPK7

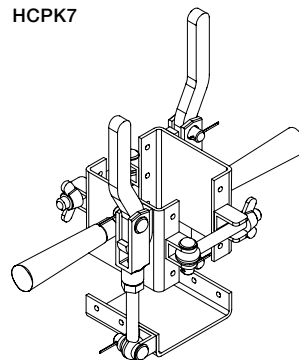

FurseWELD Accessories



Duxseal sealing compound



Copper sleeves



Cable cleaning brush,
Tape cleaning brush,
& Mould cleaning brush



Packing, Flint gun,
& Mould cleaning scraper

Accessories - FurseWELD

Part no.	Description
B135	Cable cleaning brush
BCM	Mould cleaning brush
BFC	Tape cleaning brush
DUXSEAL	Duxseal sealing compound (1 lb)
FGUN	Flint gun
FLINTS	Replacement flints (pack of 100)
HD35-HD150	Hammer die
PACK-A	Packing
S102-S111	Copper sleeve
S108A-S111A	Copper sleeve
STM1-FU	Mould cleaning scraper
TB100-FU	Welding toolbox
TK100	Standard toolkit for bar to bar joints Includes flint gun (FGUN), tape cleaning brush (BFC), mould cleaning brush and scraper (BCM & STM1-FU)
TK200	Standard toolkit for cable to cable joints Includes flint gun (FGUN), cable cleaning brush (B135), mould cleaning brush and scraper (BCM & STM1-FU)
MJ4	Mould jacket (Price Key 3 & 4)
MJ5	Mould jacket (Price Key 5)



Welding toolbox



Mould jacket

The Furse mould jacket is designed to permit safe and secure transportation and storage of FurseWELD moulds. Manufactured from woven Kevlar synthetic material with silicate padding and Velcro lined edges, the jacket protects against splashing of hot metal sparks, and prevents moisture ingress and damage to the mould.

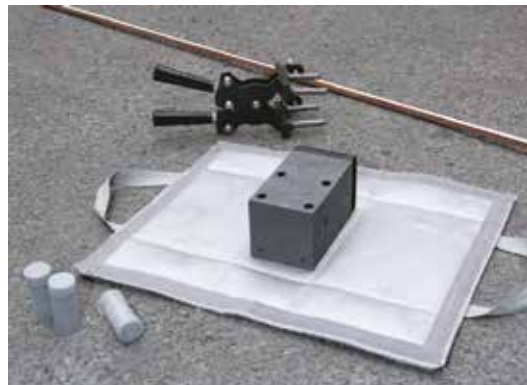



Electronic systems protection

Electronic systems protection

Introduction	10/2
Simplified product selection	10/11
Product selection guide	10/14

Electronic systems protection

Introduction



The information provided in these introductory pages follows the requirements for transient overvoltage (surge) protection provided by both IEC/BS EN 62305 and the latest amendment of the IET Wiring Regulations 17th Edition, BS 7671:2008 (+A1:2011).

10

What transients are and why you need protection

Transient overvoltages are short duration, high magnitude voltage peaks with fast rising edges, commonly referred to as surges. Often described as a “spike”, transient voltages can reach up to 6000 V on a low-voltage consumer network, with no more than a millisecond duration.

Lightning strikes are the most common source of extreme transient overvoltages where total outage of an unprotected system can occur with damage to cabling insulation through flashover potentially resulting in loss of life through fire and electric shock.

However, electrical and electronic equipment is also continually stressed by hundreds of transients that occur every day on the power supply network through switching operations of inductive loads such as air-conditioning units, lift motors and transformers.

Switching transients may also occur as a result of interrupting short-circuit currents (such as fuses blowing).

Although switching transients are of a lower magnitude than lightning transients, they occur more frequently and equipment failures unexpectedly occur often after a time delay; degradation of electronic components within the equipment is accelerated due to the continual stress caused by these switching transients.

Transient overvoltages, whether caused by lightning or by electrical switching, have similar effects: disruption (e.g. data loss, RCD tripping), degradation (reduced equipment lifespan), damage (outright equipment failure, particularly concerning for essential services such as fire and security alarm systems) and downtime - the biggest cost to any business such as lost productivity and product spoilage, staff overtime, delays to customers and sales lost to competitors.

Protection against lightning and switching transients

IEC/BS EN 62305 takes account of protection measures on metallic service lines (typically power, signal and telecom lines) using transient overvoltage or surge protective devices (SPDs) against both direct lightning strikes as well as the more common indirect lightning strikes (often described as the secondary effects of lightning) and switching transients.

Standards such as BS EN 61643 series define the characteristics of lightning currents and voltages to enable reliable and repeatable testing of SPDs (as well as lightning protection components).

Although these waveforms may differ from actual transients, the standardized forms are based upon years of observation and measurement (and in some cases simulation). In general they provide a fair approximation of the real world transient.

Transient waveforms have a fast rising edge and a longer tail. They are described through their peak value (or magnitude), rise time and their duration (or fall time). The duration is measured as the time taken for the test transient to decay to half its peak value.

The common current and voltage waveforms used to test SPDs for mains, signal and telecom lines

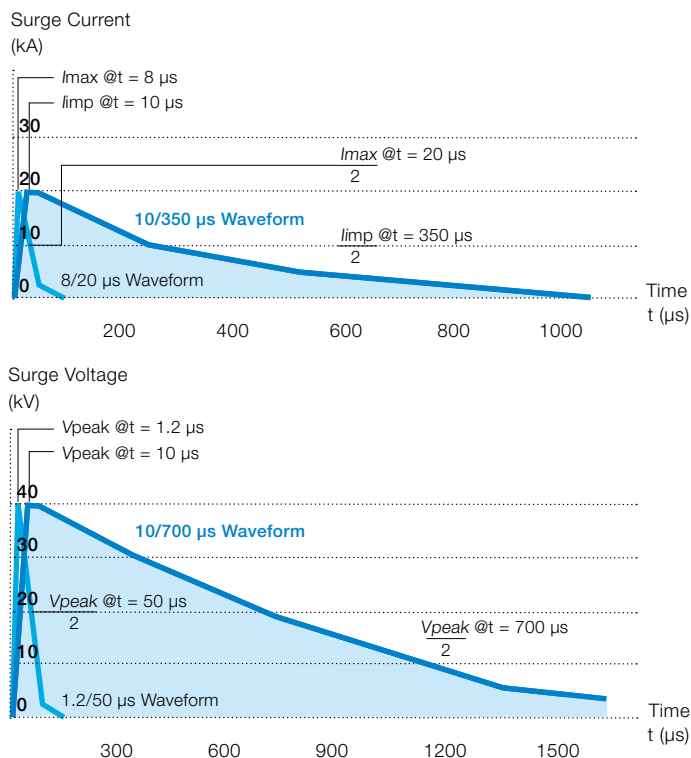

1 Transient overvoltage damage to a circuit board | 2 Most damage is barely visible



Electronic systems protection

Introduction

Lightning currents as a result of direct lightning strikes are represented by the simulated 10/350 μs waveform with a fast rise time and long decay that replicates the high energy content of direct lightning.

Direct lightning can inject partial lightning currents of the 10/350 μs waveform into a system where a structure with a structural Lightning Protection System (LPS) receives a direct strike (Source S1) or where lightning directly strikes an overhead service line (Source S3).

Remote or indirect lightning flashes near the structure (Source S2) or near a connected service to the structure (Source S4) of up to 1 km radius away (and hence far more common) are represented by the 8/20 μs waveform. Induced surges from direct lightning flashes and switching sources are also represented by this waveform.

With a much shorter decay or fall time relative to the 10/350 μs waveform, the 8/20 μs waveform presents significantly less energy (for an equivalent peak current) but is still devastating enough to damage electrical and electronic equipment.

IEC/BS EN 62305-1 recognizes that failure of internal systems (Damage Type D3) due to Lightning Electromagnetic Impulse (LEMP) is possible from all points of strike to the structure or service - direct or indirect (all Sources: S1, S2, S3 and S4).

To ensure continuous operation of critical systems even in the event of a direct strike, SPDs are essential and are suitably deployed, based on the source of surge and its intensity using the Lightning Protection Zones (LPZ) concept within IEC/BS EN 62305-4.

1 Illustration of lightning current flow from a direct strike to a structure (Source S1) | 2 Illustration of lightning current flow from a direct strike to a nearby service (Source S3) | 3 Illustration of lightning current flow from a direct strike near the structure (Source S2) | 4 Illustration of lightning current flow from lightning flashes near connected services (Source S4)

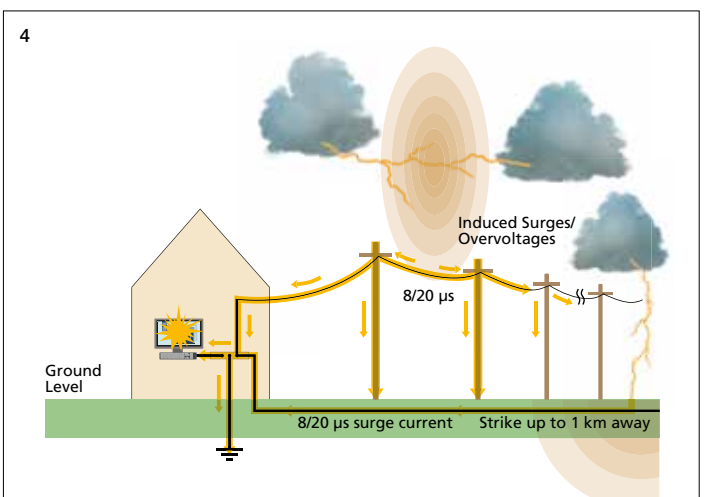
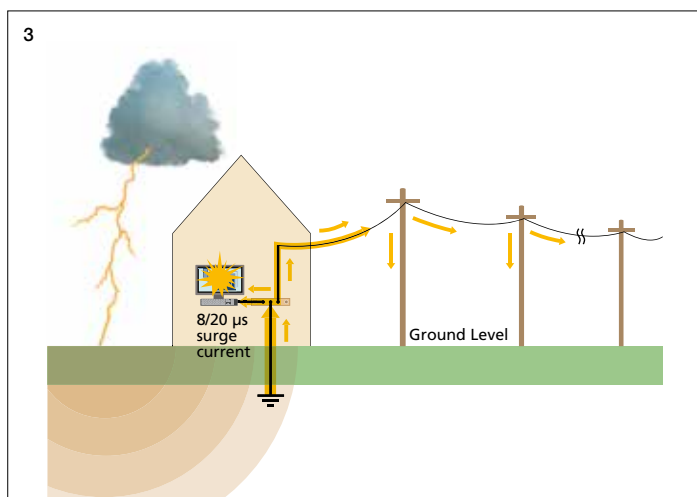
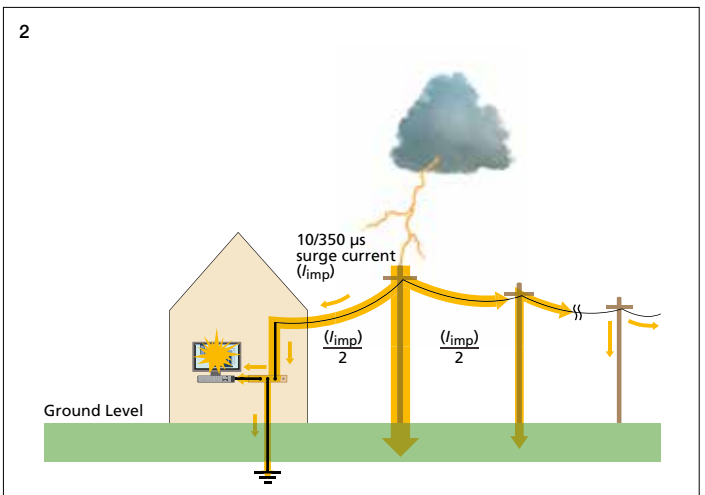
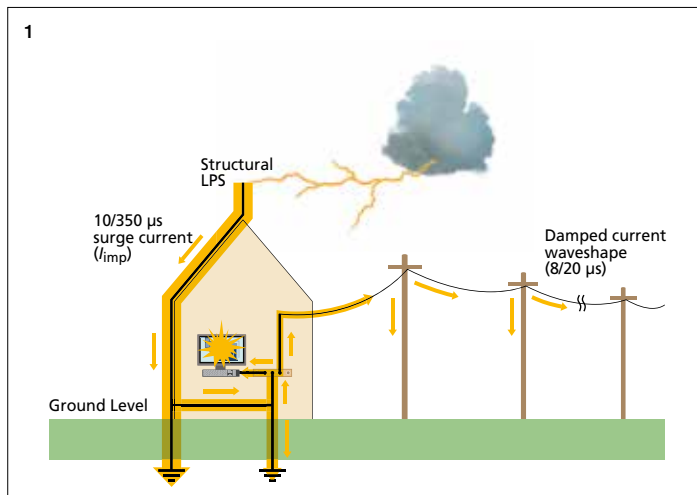

A series of zones is created within the structure according to the level of threat posed by the LEMP with each zone to have successively less exposure to the effects of lightning - for example LPZ 0 (outside the structure) where the threat of lightning currents and fields is most severe being more onerous than LPZ 3 (within the structure) where the threat of lightning is considerably reduced such that electronics can be safely located within this zone.

Figure 1. illustrates the basic LPZ concept defined by protection measures against LEMP as detailed in IEC/ BS EN 62305-4. Equipment is protected against both direct and indirect lightning strikes to the structure and connected services, through the use of Surge Protection Measures (SPM), formerly referred to as a LEMP Protection Measures System (LPMS).

To achieve this reduction in LEMP severity, from conducted surge currents and transient overvoltages, as well as radiated magnetic field effects, successive zones use a combination of shielding measures, bonding of incoming metallic services such as water and gas and the use of coordinated SPDs (further details can be found in the Furse Guide to BS EN 62305 Protection Against Lightning).

Given that the live cores of metallic electrical services such as mains power, data and telecom cables cannot be bonded directly to earth wherever a line penetrates each LPZ, a suitable SPD is therefore needed.

The SPDs characteristics at the boundary of each given zone or installation location need to take account of the surge energy they are to be subject to as well as ensure the

transient overvoltages are limited to safe levels for equipment within the respective zone.

Table 1, below, details the standardized test waveforms with peak currents used to test SPDs typically located at each zone boundary.

Figure 1. Basic LPZ concept - IEC/ BS EN 62305-4

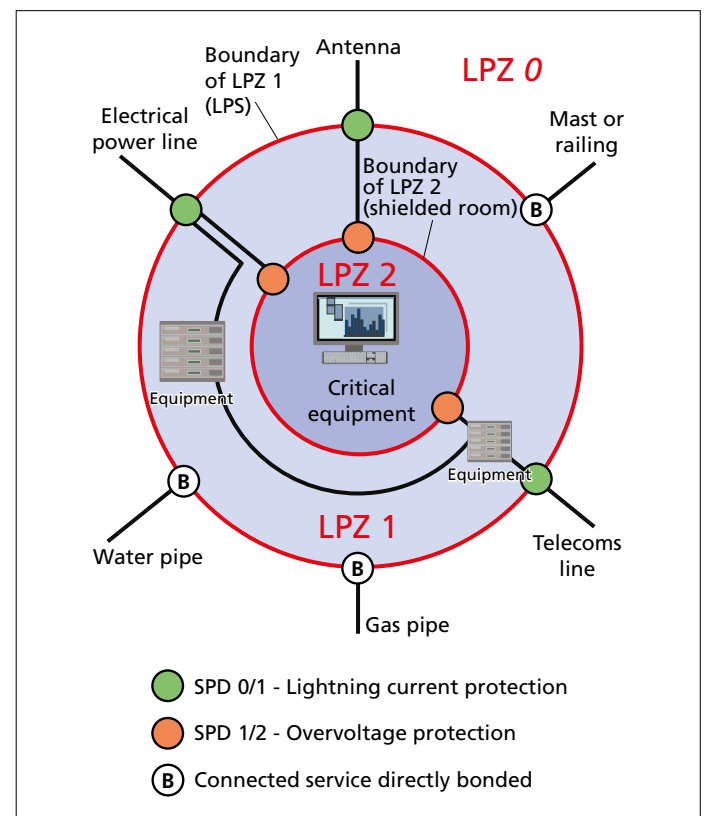

Table 1: Standardized test waveforms with peak currents used to test SPDs at each LPZ boundary

SPD location/LPZ boundary	LPZ 0/1	LPZ 1/2	LPZ 2/3
Typical SPD installation point	Service Entrance (e.g. Main distribution board or telecom NTP)	Sub-distribution board or telecom PBX frame	Terminal Equipment (e.g. socket outlet)
Mains Test Class/SPD Type ⁽¹⁾	I/1	II/2	III/3
Surge test waveform	10/350 current	8/20 current	Combination 8/20 current and 1.2/50 voltage
Typical peak test current (per mode)	25 kA ⁽²⁾	40 kA	3 kA (with 6 kV)
Signal/Telecom Test Category ⁽¹⁾	D1 ⁽³⁾	C2 ⁽³⁾	C1
Surge test waveform	10/350 current	Combination 8/20 current and 1.2/50 voltage	Combination 8/20 current and 1.2/50 voltage
Typical peak test current (per mode)	2.5 kA	2 kA (with 4 kV)	0.5 kA (with 1 kV)

⁽¹⁾ Tests to BS EN 61643 series

⁽²⁾ Peak current (per mode) for a 3 phase SPD to protect a TN-S mains system

⁽³⁾ Test category B2 10/700 voltage waveform (also within ITU-T standards) up to 4 kV peak also permissible

Electronic systems protection

Introduction

Types of SPD

IEC/BS EN 62305 deals with the provision of SPDs to protect against both the effects of indirect lightning strikes and high-energy direct lightning strikes.

- Direct lightning strikes are protected by lightning current or equipotential bonding SPDs (Mains Type 1 SPDs & Signal/Telecom SPDs to Test Category D)
- Indirect lightning strikes and switching transients are protected by transient overvoltage SPDs (Mains Type 2 and Type 3 SPDs and Signal/Telecom SPDs to Test Category C)

Lightning current or equipotential bonding SPDs

Lightning current/equipotential bonding SPDs are designed to prevent dangerous sparking caused by flashover.

Flashover is caused when the extremely high voltages associated with a direct lightning strike breaks down cable insulation. This can occur between the structural LPS and electrical services and presents a potential fire hazard and risk from electric shock.

Transient overvoltage SPDs

Transient overvoltage SPDs are designed to protect electrical/electronic equipment from the secondary effects of indirect lightning and against switching transients. SPDs should be installed at sub-distribution boards and at equipment level for critical equipment.

IEC/BS EN 62305 refers to the correct application of lightning current and transient overvoltage SPDs as a coordinated set where the service entrance lightning current SPD handles the majority of surge energy and prevents flashover whilst the downstream transient overvoltage SPDs ensure equipment protection by sufficiently limiting the overvoltages.

For further information, please refer to the Furse Guide to BS EN 62305 Protection Against Lightning.

IEC/BS EN 62305-2 Risk Management is used to evaluate the required level of lightning protection measures necessary to lower the risk of damage to a particular structure, its contents and occupants to a defined tolerable level.

If the risk evaluation demands that a structural LPS is required, then lightning current or equipotential bonding SPDs are always required for any metallic electrical services entering the structure.

These SPDs are necessary to divert the partial lightning currents safely to earth and limit the transient overvoltage to prevent possible flashover. They are therefore an integral part of the structural LPS and typically form the first part of a coordinated SPD set for effective protection of electronic equipment.

If the risk evaluation shows that a structural LPS is not required but there is an indirect risk, any electrical services feeding the structure via an overhead line will require lightning current SPDs typically installed at the service entrance, with coordinated transient overvoltage SPDs downstream to protect electronic equipment.

In order to provide effective protection, a transient overvoltage protector/SPD must:

- Be compatible with the system it is protecting
- Survive repeated transients
- Have a low 'let-through' voltage, for all combinations of conductors (enhanced SPDs to IEC/BS EN 62305)
- Not leave the user unprotected, at the end of its life
- Be properly installed

Important

The primary purpose of lightning current or equipotential bonding SPDs is to prevent dangerous sparking caused by flashover to protect against the loss of human life.

In order to protect electronic equipment and ensure the continual operation of systems, transient overvoltage SPDs are required. **IEC/ BS EN 62305-4 specifically states that 'a lightning protection system which only employs equipotential bonding SPDs provides no effective protection against failure of sensitive electrical or electronic systems.'**

Compatibility

The protector must not interfere with the system's normal operation:

- Mains power supply SPDs should not disrupt the normal power supply such as creating follow current that could blow supply fuses, or cause high leakage currents to earth
- SPDs for data communication, signal and telephone lines should not impair or restrict the systems data or signal transmission

Table 2: General indication of system impairments, of which manufacturers of transient overvoltage protectors should provide details

	Protectors for mains supplies		Protectors for data lines		
	Parallel protectors	In-line protectors	Low frequency protectors	Network protectors	Radio frequency protectors
Nominal operating voltage	•	•	•	•	•
Maximum operating voltage	•	•	•	•	•
Leakage current	•	•	•	•	•
Nominal current rating	–	•	•	•	•
Max continuous current rating	–	•	•	•	•
In-line impedance	–	•	•	•	•
Shunt capacitance	–	–	–	•	•
Bandwidth	–	–	•	•	•
Voltage standing wave ratio	–	–	–	•	•

Survival

It is vital that the protector is capable of surviving the worst case transients expected at its installation point/ LPZ boundary. More importantly, since lightning is a multiple event, the protector must be able to withstand repeated transients.

The highest surge currents occur at the service entrance (boundary LPZ 0 to LPZ 1). For buildings with a structural LPS, the lightning current SPD could be subject to as high as 25 kA 10/350 μ s surge currents per mode on a 3-phase TN-S/TN-C-S mains system (up to 2.5 kA 10/350 μ s per mode on a signal or telecom line) for a worst-case lightning strike of 200,000 A.

However, this 200 kA level of lightning current itself is extremely rare (approx. 1% probability of occurring) and the peak current the SPD would be subject to further assumes that a structure is only fed with one metallic service.

Almost all structures have several metallic services connected to them such as gas, water, mains, data and telecoms.

Each service shares a portion of the lightning current when the protected building receives a strike, greatly reducing the overall current seen by any single service, and as such any SPD fitted to the electric service lines.

Transient overvoltages caused by the secondary effects of lightning are considerably more common (lightning flash near a connected service up to 1 km away from the structure) and therefore are unlikely to have currents exceeding 10 kA 8/20 μ s.

Let-through voltage

The larger the transient overvoltage, the greater the risk of flashover, equipment interference, physical damage and hence system downtime.

Therefore, the transient overvoltage let through the protector (also known as the voltage protection level U_p of the SPD) should be as low as possible and certainly lower than the level at which flashover, interference or component degradation may occur.

Transient overvoltages can exist between any pair of conductors:

- Phase to neutral, phase to earth and neutral to earth on mains power supplies
- Line to line and line(s) to earth on data communication, signal and telephone lines

Thus, a good protector (enhanced SPDs to IEC/BS EN 62305) must have a low let-through voltage between every pair of conductors.

Electronic systems protection

Introduction

Enhanced performance SPDs - SPD*

IEC/BS EN 62305-2 details the application of improved performance SPDs to further lower the risk from damage. The lower the sparkover voltage, the lower the chance of flashover causing insulation breakdown, electric shock and fire.

SPDs that offer lower let-through voltages further reduce the risks of injury to living beings, physical damage as well as failure and malfunction of internal systems. All Furze ESP protectors offer such superior protection and are termed as enhanced performance SPDs (SPD*) in line with IEC/BS EN 62305.

Enhanced SPDs can also satisfy more than one test class/category by handling both high-energy partial lightning currents of 10/350 μ s waveshape whilst offering very low let-through voltages. Such enhanced SPDs may be suitable for changing a lightning protection zone from LPZ 0 right through to LPZ 3 at a single boundary or installation point. As such they provide both technical and economic advantages over standard SPDs.

End of life

When an SPD comes to the end of its working life it should not leave equipment unprotected. Thus in-line protectors should take the line out of commission, preventing subsequent transients from damaging equipment.

SPDs for data communication, signal and telephone lines and protectors for low current mains power supplies are usually in-line devices. Where SPDs are installed at mains power distribution boards it is usually unacceptable for these to suddenly fail, cutting the power supply.

Consequently, to prevent equipment being left unprotected, the SPD should have a clear pre end-of-life warning, which allows plenty of time for it to be replaced.

Installation

The performance of SPDs is heavily dependent upon their correct installation. Thus, it is vital that SPDs are supplied with clear installation instructions.

The following is intended to supplement the detailed guidance given with each product in order to give a general overview of installation. This should not be viewed as a substitute for the Installation Instructions supplied with the SPD. Copies of these are available separately on request.

Installing parallel connected SPDs for mains power supplies:

- SPDs should be installed very close to the power supply to be protected, either within the distribution panel or directly alongside of it (in an enclosure to the required IP rating)
- Connections between the SPD and phase(s), neutral and earth of the supply should be kept very short (ideally 25 cm or less, but no more than 50 cm)
- SPD performance is further enhanced by tightly binding connecting leads together (simply using cable ties or similar), over their entire length
- For safety and convenient means of isolation, the phase/live connecting leads should be suitably fused using HRC fuses or switchfuse, MCB or MCCB

Installing in-line SPDs for data, signal, telephone or power:

- SPDs are usually installed between where cabling enters or leaves buildings and the equipment being protected (or actually within its control panel)
- The installation position should be close to the system's earth star point (usually the mains power earth) to enable a short and direct connection to earth
- In-line, or series, connected SPDs generally have connections marked line and clean. The line end of the SPD should be connected to the incoming or "dirty" line (from where the transient is expected). The clean end of the SPD should be connected to the line or cable feeding the equipment
- Cables connected to the SPDs clean end should never be routed next to dirty line cables or the SPDs earth bond
- Unless ready-boxed, SPDs should be installed within an existing cabinet/cubicle or in an enclosure to the required IP rating

How to apply protection

Transient overvoltages are conducted into the sensitive circuitry of electronic equipment on power and data communication, signal and telephone lines. Protection is recommended for:

- All cables which enter or leave the building (except fibre optic)
- The power supply local to important equipment
- Electronic equipment outside the main building(s)

Protecting incoming and outgoing electrical services

Lightning strikes between clouds or to ground (and objects upon it) can cause transient overvoltages to be coupled on to electrical cables, and hence into the sensitive electronic equipment connected to them.

To protect the electronic equipment inside a building, all cables that enter or leave the building must be protected. Cables leaving the building can also provide a route back into the building for transients.

For each building protect incoming/outgoing:

- Mains power supplies (including UPS supplies)
- Data communication and local area network cables
- Signal, control, instrumentation and alarm lines
- CCTV, satellite, TV and antenna cables
- Telephone and telemetry lines

Protect the power supply locally to important equipment

In addition to installing protection on the mains power supply as it enters/leaves the building, protection should also be installed locally to important equipment. Protection at the main LV (low voltage) incomer(s) is necessary to prevent large transients from entering the building's power distribution system, where they could have far reaching effects.

However, where the cable run to equipment exceeds 10 metres (to BS 7671 Clause 534.2.3.1.1), transient overvoltages may appear on the mains after the protector at the main LV incomer. These transients can result from:

- The electrical switching of large inductive loads within the building
- A lightning strike to the building - as lightning currents flow through down conductors transient overvoltages can be induced on to nearby power cables
- The natural inductance and capacitance of long cable runs, 'amplifying' the voltage 'let-through' the protector at the main LV incomer

Additionally, local protection guards against the possibility of a supply which enters/leaves the building being overlooked and left unprotected.

Protect data lines locally

Generally, the biggest risk to data, signal, telecom and network wiring is associated with cables that enter and leave the building.

These should always be protected. However, data cables within a building can additionally have transients induced on to them when loops between data and power cables 'pick up' voltages from the magnetic field caused by a lightning strike.

As part of the overall SPM, IEC/BS EN 62305 advocates the use of metal in the structure, and a Faraday cage lightning protection system to help exclude magnetic fields.

Cable management practices eliminate loops by routing data and power cables along the same general path. In these cases, the need for local data line protection is minimal. However, where these steps are not possible, data line protection, local to the equipment requiring protection, should be considered.

Protect electronic equipment outside the building

On site or field based electronic equipment with mains power, data communication, video, signal or telephone line inputs will need to be protected against transient overvoltages. It may be helpful to think of each equipment cabinet or cubicle as a separate building with incoming/outgoing cables to be protected.

Complementary techniques

As well as the use of transient overvoltage protectors, IEC/BS EN 62305 outlines additional protection techniques (e.g. shielding measures), which can be used to help reduce the transient threat as part of the overall SPM.

These are described further in the Furze Guide to BS EN 62305 Protection Against Lightning. Where these can be used, principally on new build or refurbishment projects, they need to be supported by the use of SPDs.

Electronic systems protection

Introduction

Special product development

Whilst this catalogue focuses on our standard product range which meets a wide variety of applications, on occasion a customer will have a special requirement which needs transient overvoltage protection.

In these circumstances we have the technical capability in-house to design and propose a specific solution to meet the customer's special requirement.

Following our proposal, technical and performance parameters of the SPD can be finalized, and the special product manufactured to order.

Special products completed to date include:

- Low-current supply protection to industrial microwave ovens
- Media distribution protection (TV/Radio/DAB on 19" rack)
- Integrated photovoltaic inverter protection
- Overvoltage disconnect for battery-charger installations within substations

For more information about special product development, or to discuss a particular project, please contact us.

Common terminology and definitions

The following common terminologies, as recognized by IEC/BS EN 61643, are used throughout SPD specifications in order to aid correct selection and are defined as follows:

Nominal Voltage U_o is the phase to neutral AC RMS voltage of the mains system (derived from the nominal system voltage for which the SPD is designed. U_o is the voltage by which the power system is designated e.g. 230 V.

Maximum Continuous Operating Voltage U_c is the maximum RMS voltage that may be continuously applied to the SPDs mode of protection e.g. phase to neutral mode. This is equivalent to the SPDs rated peak voltage.

Temporary Overvoltage U_T is the stated test value of momentary voltage increase or overvoltage that the power SPD must withstand safely for a defined time.

Temporary overvoltages, typically lasting up to several seconds, usually originate from switching operations or wiring faults (for example, sudden load rejection, single-phase faults) as well as mains abnormalities such as ferro-resonance effects and harmonics.

Impulse Current I_{imp} is defined by three parameters, a current peak with a charge and a specific energy typically simulated with the 10/350 μ s waveform to represent partial lightning currents.

This waveform is used, with peak I_{imp} current value stated, for the mains Type 1 SPD Class I test and typically for data/telecom SPD Test Category D.

Nominal Discharge Current I_n is a defined nominal peak current value through the SPD, with an 8/20 μ s current waveshape. This is used for classification of mains SPDs (Class II test) and also for preconditioning of SPDs in Class I and Class II tests. (Note: within BS 7671, I_n is referred to as I_{nspd}).

Maximum Discharge Current I_{max} is the peak current value through the SPD, with an 8/20 μ s waveshape. I_{max} is declared for mains Type 2 SPDs in accordance to the test sequence of the Class II operating duty test. In general, I_{max} is greater than I_n .

Combined Impulse Test with Open Circuit Voltage U_{oc} is a hybrid 1.2/50 μ s voltage test combined with an 8/20 μ s current.

The test is performed using a combination wave generator where its open circuit voltage is defined as U_{oc} , typically 6 kV 1.2/50 μ s for the mains Class III test and up to 4 kV 1.2/50 μ s for signal/telecom Test Category C.

With an impedance of 2 Ω , the generator also produces a peak short circuit current (sometimes referred to as I_{sc}) at half the value of U_{oc} (3 kA 8/20 μ s for the mains Class III test and up to 2 kA 8/20 μ s for signal/telecom Test Category C).

With both voltage and current test waveforms, the combined impulse test is designed to stress all technologies used within SPDs.

Voltage Protection Level U_p is the key parameter that characterizes the performance of the SPD in limiting the transient overvoltage across its terminals. A low protection level value (also known as let-through voltage) is therefore particularly critical for the effective protection and continued operation of electronic equipment.

The peak voltage protection level U_p is declared when the SPD is tested with its stated nominal discharge current I_n (or the peak current (I_{peak}) of I_{imp}) and is also declared when the SPD is subject to combined impulse test (mains Class III test for Type 3 SPDs) as well as data/telecom Test Categories C and B.

Electronic systems protection

Simplified product selection

All Furse ESP products are designed to provide simple system integration whilst achieving highest levels of effective protection against transients.

Tested in line with the IEC/BS EN standards series, ESP protection can be selected and applied to IEC/BS EN 62305 and BS 7671 easily using the SPD product application tables and data sheets. Key product and application features are represented using the following symbols:

LPZ
0 → 3

Lightning Protection Zone (LPZ) details the boundary (to IEC/BS EN 62305-4) or installation point of the SPD. For example, LPZ 0 - 3 signifies that the SPD can be installed at the service entrance boundary and create an immediate LPZ 3 suitable for protecting electronic equipment close to the SPD installation.

Equipment further downstream of this location may require additional protection, against switching transients for example.

MAINS
TEST
TYPE
1 + 2 + 3

Mains Test Type defines the Type of mains SPD (BS EN 61643 Type 1, 2, 3 or I, II, III to IEC 61643) tested with the respective test Class I (high energy 10/350 μ s current waveform), II (8/20 μ s current waveform) or III (combined 8/20 μ s current and 1.2/50 μ s voltage waveform) from the IEC/ BS EN 61643 series.

Where more than one Type is stated (for combined, enhanced Type SPDs), the SPD has been tested to each respective test Class, with the results detailed on its transient performance specification.

**SIGNAL/
TELECOM**
TEST CAT
D + C + B

Signal/Telecom Test Category indicates the Test Categories (as defined in IEC/BS EN 61643 series) that SPDs for signal and telecom systems have been subject to, with the results detailed on the transient performance specification.

Test Category D is a high-energy test typically using the 10/350 μ s current waveform. Test Category C is a fast rate of rise test using the 1.2/50 μ s voltage waveform combined with 8/20 μ s current waveform. Test Category B is a slow rate of rise test using the 10/700 μ s waveform, also used within ITU standards. Enhanced SPDs tested with categories D, C and B can offer up to LPZ 0 → 3 protection.

COMMON
MODE
Equipotential
Bonding

Common Mode signifies that the SPD specifically offers protection on conductors with respect to earth. For a mains system, this would be between phases and earth or neutral and earth. For a data/telecom line this would be between signal line(s) to earth.

Common mode surges can result in flashover if the insulation withstand voltage of connected wiring or equipment is exceeded. Flashover could lead to dangerous sparking potentially causing fire or electric shock risks. Equipotentially bonding Type 1 mains SPDs or Test Cat D tested signal/telecom SPDs reduce the risk of flashover by limiting common mode surges.

FULL
MODE
Bonding +
Equipment
Protection

Full Mode means that the SPD protects in all possible modes; common mode (live conductors with respect to earth) and differential mode (between live conductors). For example, Full Mode mains SPDs offer protection between phase(s) to earth, phase(s) to neutral and neutral to earth.

Whilst common mode protection ensures flashover is prevented, differential mode protection is critical to ensure sensitive electronics are protected as well as operational during surge activity.

E
ENHANCED
Low let-through
voltage

Enhanced SPDs (SPD* within IEC/BS EN series) have lower (better) let-through voltage or protection levels (U_p) and therefore further reduce the risk of injury to living beings, physical damage and failure of internal electronic systems. Enhanced Type 1 mains SPDs (for a 230/400 V system) should have a protection level U_p of no more than 1600 V whilst Type 2 and Type 3 mains SPDs should have a protection level U_p of no more than 600 V in all modes when tested in accordance with IEC/BS EN series. Enhanced signal/telecom SPDs should typically have a protection level U_p no more than twice the peak operating voltage of the protected system.

Electronic systems protection

Simplified product selection

3-WAY + N-E FAULT STATUS INDICATION

Status Indication for mains wire-in power distribution SPDs is essential as they are installed in parallel or shunt with the supply and as such could potentially leave the system unprotected should the SPD fail. 3-way status indication of the SPDs condition provides simple and clear visual inspection and further provides advanced pre-failure warning such that the system is never unprotected. Furthermore warning of potentially fatal neutral to earth faults due to incorrect earthing and wiring faults for example is provided with additional flashing indication.

REMOTE INDICATION LED DISPLAY

Remote Indication is an innovative feature that further optimizes mains wire-in SPD protection. A parallel or shunt installed SPD has additive let-through voltage because of its connecting leads that need to be kept as short as possible - ideally no more than 25 cm. Often an SPD cannot be mounted in its optimum position without compromising the visibility of its status indication.

Innovative remote status indication displays overcome this by allowing the SPD to be mounted with short connecting leads with the separate status display being conveniently mounted in a visible position such as the front of a power distribution cabinet providing convenient and effective equipment protection.

ACTIVE VOLT-FREE CONTACT

Active Volt-free Contact is an essential addition to the visual 3-way status indication.

The changeover volt-free contact is simply connected or linked to an existing building management system, buzzer or light and should the SPD have a pre-failure condition, this would be remotely indicated - particularly important for remote installations where the building management system would be connected to a telecom modem.

Active contacts further enable the SPD to also conveniently warn of phase loss from a power failure or blown fuse.



Intelligent Display iD is an innovation from Furse that encompasses existing features of 3-way SPD status indication with Neutral to Earth voltage warning but through clear easy to read text on an illuminated LCD display.

Often SPDs should be mounted on their side in order to facilitate short connecting leads for better protection levels but as this compromises the position and appearance of the status indication, it is not widely practiced.

Also available in a remote display option, the iD feature enhances mains wire-in SPD installation as the status indication text can easily be rotated (in 90° steps, clockwise) at the push of a button to aid good installation practice.

CURRENT RATING 4 A

Current Rating indicates the maximum continuous current rating of in-line SPDs for data communication, signal and telephone lines.

The SPDs quoted maximum continuous current rating should always exceed the peak running current of the protected system to ensure normal system operation is not impaired.

Damage, through overheating, would result if its quoted current rating were exceeded.

LOW IN-LINE RESISTANCE 1 Ω

Low In-line Resistance states the resistance value in Ohms (Ω) per line of SPDs for data communication, signal and telephone lines.

A low in-line resistance is desirable; particularly for systems with high running currents in order to reduce any voltage drops across the SPD and ensure normal system operation is not impaired.

Consideration should be made for additional SPDs installed on the same line to protect connected equipment at each end of the line (e.g. CCTV camera and connected monitoring equipment) as the in-line resistance of each SPD is introduced into the system.

REPLACEABLE
PROTECTION
MODULE

Replaceable Protection Module indicates that the SPD component providing protection can be easily removed and replaced following end-of-life with an appropriate replacement module, saving on reinstallation time and protector cost.

The replaceable module includes a quick release mechanism allowing partial removal, which facilitates line commissioning and maintenance.

LED
OPTIONAL
INDICATION

LED Optional Indication is an additional feature where an SPD can be supplied with an integral LED which indicates performance or fault when installed in low current DC power applications.

This enables rapid assessment and replacement of SPDs in situations where a considerable number of SPDs are installed.

HIGH
BANDWIDTH

High Bandwidth SPDs ensure the full system frequency range of transmission signals, for protected data communication, signal and telephone lines, is not impaired.

Signal frequencies outside the stated SPD bandwidth may potentially be distorted causing information loss or corruption.

As the SPD should accommodate the characteristics of the protected system, the stated SPD bandwidth (typically quoted for a 50 Ω system) should always exceed the protected system's bandwidth.



BX IP is an International Protection (IP) rating (to IEC/BS EN 60529) for ready-boxed (BX) SPDs typically used in dusty and damp environments.

The IP rating system (also interpreted as “Ingress Protection”) classifies the degrees of protection provided against the intrusion of solid objects (including body parts like hands and fingers), dust, accidental contact and water in electrical enclosures. For example, an IP66 rated enclosure provides no ingress of dust and therefore complete protection against contact as well as against water projected in powerful jets against the enclosure from any direction with no harmful effects.

Unboxed SPDs should be installed within distribution panels/cabinets or within external enclosures to the required IP rating (such as the Furse weatherproof WBX enclosure range).



Ultra Slim 7 mm Width highlights the Slim Line feature of our ESP SL range which permits installation in tight spaces, or multiple installation where a high number of lines require protection.



ATEX/IECex Approved indicates that this SPD has undergone the relevant testing and approval process defined by ATEX/IECex, and has proven suitable for use in the hazardous environment as defined on the SPD datasheet.

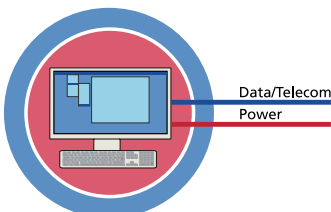

WARNING Equipment is **ONLY** protected if all incoming lines have protection fitted



Electronic systems protection

Product selection guide

Product selection guide - Electronic systems protection

No.	Type	Section / Page No.
1.	Mains wire-in protectors	11/4
2.	Mains wire-in protectors	11/8, 11/16
3.	Mains wire-in protectors	11/4
4.	Mains wire-in protectors	11/4
5.	PBX telephone/ISDN line protection	13/1
6.	Plug-in telephone line protection, or Wire-in telephone line protection	13/14 12/4, 12/10
7.	CCTV video protectors	14/14
8.	Computer network protector	13/8
9.	RF signal protector	14/16
10.	Mains wire-in protector	11/8, 11/16
11.	Plug-in mains protector	11/24
12.	Protectors for low current mains power supplies	11/22
	CCTV video and	12/14
	Telemetry lines	14/14
13.	Mains wire-in protectors	11/14
14.	Mains wire-in protectors	11/14
	Computer network protector	13/8
	PBX telephone/ISDN line protection	13/6

We've described in the ESP introduction how protection should be installed on all cables which enter or leave the building (except fibre optic), the power supply local to important equipment and electronic equipment outside the main building(s). With the aid of the illustration we can see how this might be applied in practice.

Protect incoming and outgoing electrical services

We'll start by considering the main (office) building in isolation.



Incoming mains power supplies

Install protection on the incoming mains power supply at the incoming distribution board(s).

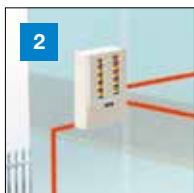

If, as in this example, there are any other power supplies entering the building install protection on these near where they enter the building.

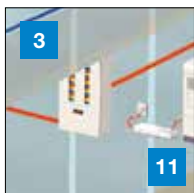

Incoming mains power supplies

Outgoing supplies can provide transient overvoltages with a route back into the building's power distribution system. Install protection on supplies to other buildings. (Note how, if correctly positioned, the protector at the incoming distribution board (1), also protects against transients from the outgoing supply to the UPS building).

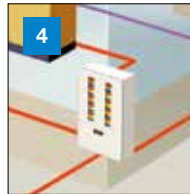

Install protection on outgoing supplies to site services, such as CCTV systems and site lighting. Protect all incoming/outgoing data communication, signal and telephone lines (unless fibre optic).

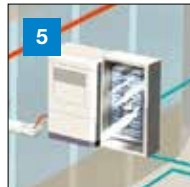

Telephone lines

Incoming telephone lines and extensions that leave the building have protectors installed on them at the PBXs distribution frame.



In our example, there is a direct (i.e. not via the PBX) telephone line to an alarm panel, which also needs protecting.

Main aspects and individual components of a system of surge protection methods

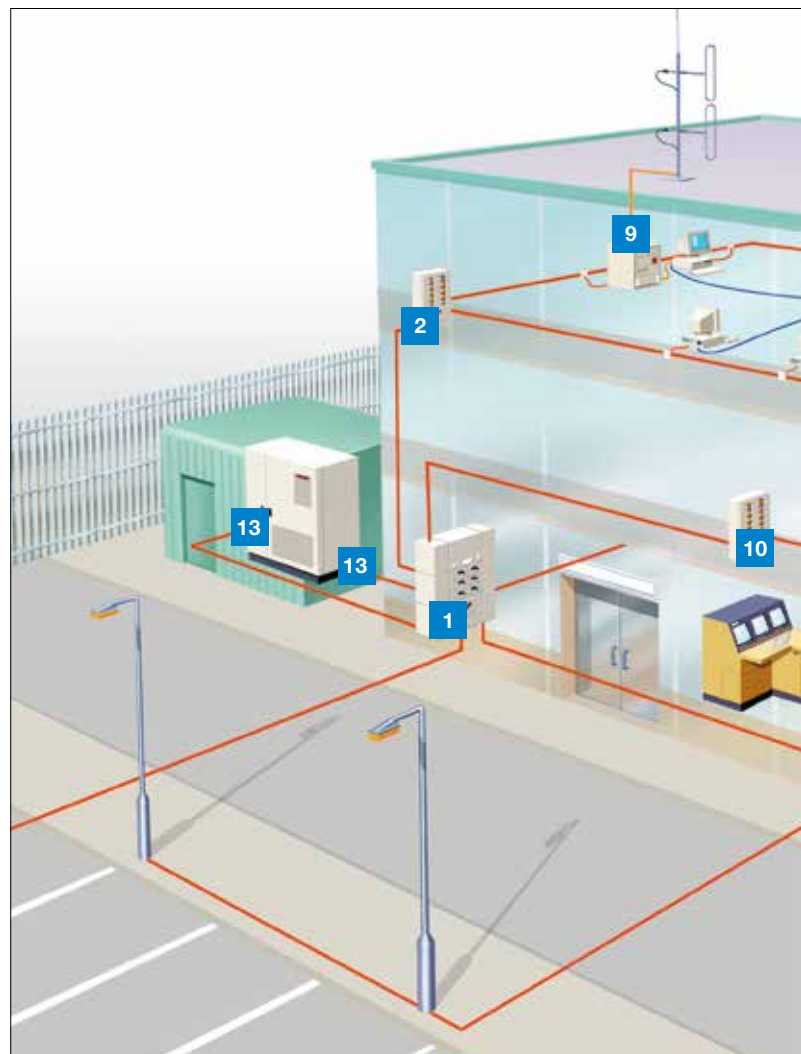

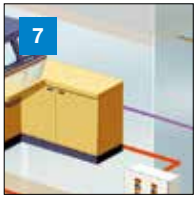

Data & signal lines

Protectors are installed on CCTV video cables from outdoor cameras to prevent damage to the control desk.



A protector is installed at the network hub to protect it from transients on the between building data link.

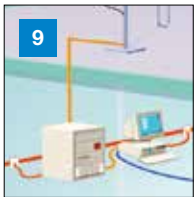

Equipment such as our RF receiver, with antenna (or satellite) links will also need protecting.

Protect the power supply locally to important equipment

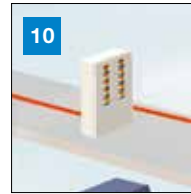

Within the building transient overvoltages can be injected on to the mains power supply (downstream of the protector at the incomer). Consequently, protectors should be installed close to important pieces of equipment.

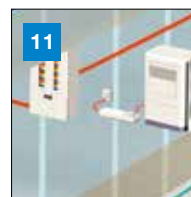

CCTV cameras

Protect outdoor CCTV cameras with protectors on the power supply, and video cable (and, if relevant, telemetry control line). The telephone PBX is protected locally by a plug-in protector.

Protect electronic equipment outside the building

Electronic equipment outside the main building in ancillary buildings, on site or in the field should also be protected.



CCTV cameras

Protect outdoor CCTV cameras with protectors on the power supply, and video cable (and, if relevant, telemetry control line).



External buildings

If the UPS is housed in a separate building with a separate earth, incoming and outgoing supplies will need to be protected. This is because most modern UPS systems contain electronics that make them vulnerable to being disabled by transient overvoltages. To prevent transient overvoltage damage to the UPS it must have a protector installed on both its input and output (outgoing the building). A protector will also need to be installed on the power supply into the main building (2).

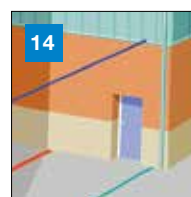

Data communication/telephone lines

Protection is also installed on mains power, data communication and telephone lines entering the neighbouring building. Additional protection (not shown) may be required within this building (whether it's a computer-controlled warehouse or automated manufacturing operation with PLCs, drives and computer controls).

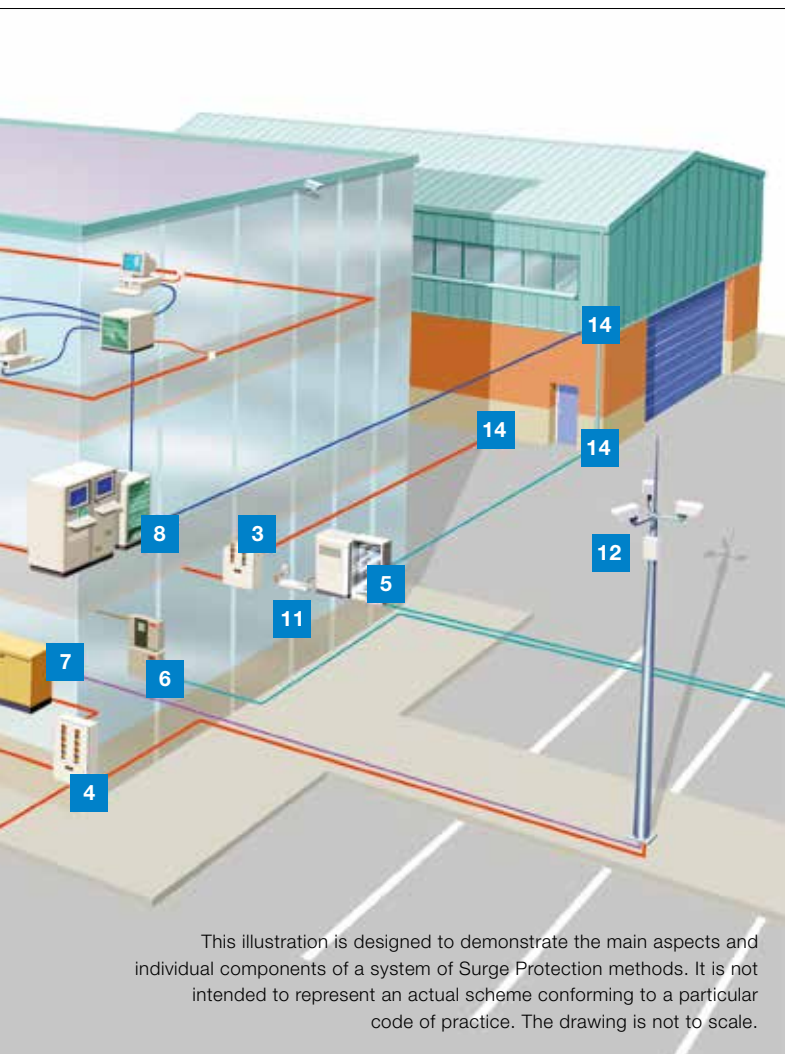

10



Electronic systems protection

Mains power protection

Mains power protection

Product selector - Service entrance to terminal equipment	11/2
ESP 240/XXX Series	11/4
ESP 415/XXX Series	11/6
ESP D1 Series (Single phase)	11/8
ESP D1 Series (Three phase)	11/10
ESP M2/M4 Series	11/12
ESP M1 Series	11/14
ESP M1R, M2R & M4R Series	11/16
ESP DC Series	11/18
ESP D/DS 10A & 32A Series (Single phase)	11/20
ESP 5A/BX & 16A/BX Series	11/22
ESP MC Series	11/24



Mains power protection

Product selector - Service entrance to terminal equipment

		Installation Locations		
Structure configuration - typical		Service entrance - after meter Main Distribution Board (MDB)	Sub Distribution Board (SDB) - located > 10m from MDB	Critical terminal equipment - located > 10 m from SDB
<p>No external lightning protection system LPS fitted, 3 Phase 415V TN-S or TN-C-S mains supply - underground supply feed</p> 	 <p>ESP 415 D1 Series or ESP 415 M1 Series For 3 Phase 415V supplies See pages 11/10 and 11/14</p>	 <p>ESP 415 D1 Series For 3 Phase 415V supplies. See page 11/10.</p>	 <p>ESP MC Series Hospital/Laboratory/Server equipment. See page 11/26.</p>	
<p>No external lightning protection system LPS fitted, 3 Phase 415V TN-S or TN-C-S mains supply - exposed overhead supply feed</p> 	 <p>ESP 415/III/TNS Series or where electronics are located near MDB before SDB use ESP 415 M2 Series See pages 11/6 and 11/12</p>	 <p>ESP 415 M1 Series For 3 Phase 415V supplies. See page 11/14.</p>	 <p>ESP MC/TN/RJ11 Series Fax machines/Modems See page 11/26.</p>	
<p>External lightning protection system LPS fitted, multiple connected metallic services (gas/water/ data/telecom) 3 Phase 415V TN-S or TN-C-S mains supply</p> 	 <p>ESP 415 D1 Series or For 3 Phase 415V supplies ESP 415 M1 Series See pages 11/10 and 11/14</p>	 <p>ESP 240 D1 Series For single phase 240V supplies. See page 11/6.</p>	 <p>ESP MC/Cat-5e Series Computer network hubs See page 11/26.</p>	
<p>External lightning protection system LPS fitted, metallic gas/water/ data/telecom services -unknown 3 Phase 415V TN-S or TN-C-S mains supply</p> 	 <p>ESP 415/I/TNS Series for LPS to LPL level I and II ESP 415/III/TNS Series for LPS to LPL level III and IV or where electronics are located near MDB before SDB use ESP 415 M2 Series for LPS to LPL level III & IV are located near MDB before SDB ESP 415 M4 Series for LPS to LPL level I & II are located near MDB See pages 11/4 and 11/12</p>	 <p>ESP 240 M1 Series For single phase 240V supplies. See page 11/14.</p>	 <p>ESP MC/Cat-5e Series Computer network hubs See page 11/26.</p>	
<p>Mains protectors for specific systems</p> <p>Fire/intruder alarm panels and CCTV systems</p>  <p>ESP In line mains up to 32 Amps. See pages 11/22 & 11/24 Fire/Intruder alarm panels See page 11/20</p>		<p>Photovoltaic (solar) panels</p>  <p>ESP PV Series Photovoltaic (solar) panels See page 14/8.</p>		
		 <p>WARNING Equipment is ONLY protected if all incoming lines have protection fitted</p>		

Mains power protection

ESP 240/XXX Series

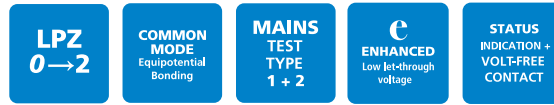

Combined Type 1 and 2 tested protector (to BS EN 61643) for use on the main distribution board, particularly where a structural Lightning Protection System (LPS) is employed, for equipotential bonding. For use at boundaries up to LPZ 0 to protect against flashover (typically the main distribution board location) through to LPZ 2 to protect electrical equipment from damage.

Features & benefits

- Enhanced protection (to IEC/BS EN 62305) offering low let-through voltage further minimizing the risk of flashover creating dangerous sparking or electric shock
- Repeated protection in lightning intense environments
- Compact, space saving design
- The varistor based design eliminates the high follow current (I_f) associated with spark gap based surge protection
- Indicator shows when the protector requires replacement
- Remote signal contact can indicate the protector's status through interfacing with a building management system

Application

- Use on single phase mains supplies and power distribution systems for protection against partial direct or indirect lightning strikes
- ESP 240/I/XXX versions for use with Class I or II LPS
- ESP 240/III/XXX versions for use with Class III or IV LPS; or exposed overhead single phase power lines where no LPS is fitted
- ESP 240/X/TNS versions also cover TN-C-S earthing systems

Installation

Protector to be installed in the main distribution board with connecting leads of minimal length. The protector should be fused and is suitable for attachment to a 35 mm top hat DIN rail. The diagrams below illustrate how to wire the appropriate ESP protector according to your chosen electrical system.

11

Accessories

Weatherproof enclosure:

WBX D4

Full product range order codes can be found on pages 17/8-17/9

TN-S earthing system

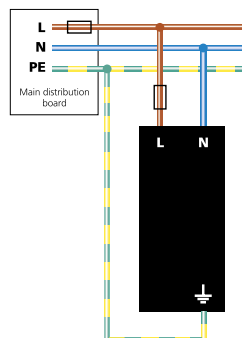

TN-C earthing system

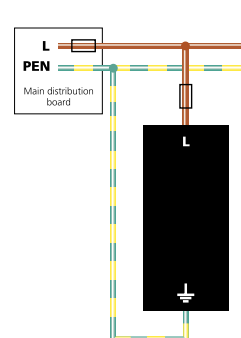

TT earthing system

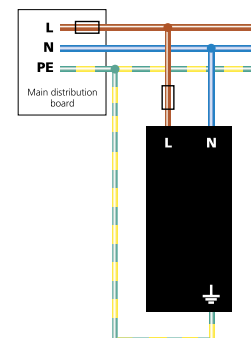

IMPORTANT: The primary purpose of lightning current or equipotential bonding mains Type 1 Surge Protective Devices (SPDs) is to prevent dangerous sparking caused by flashover to protect against the loss of human life. In order to protect electronic equipment and ensure the continual operation of systems, transient overvoltage mains Type 2 and 3 SPDs such as the ESP M1 Series or ESP D1 Series are further required, typically installed at downstream subdistribution boards feeding sensitive equipment. IEC/BS EN 62305 refers to the correct application of mains Type 1, 2 and 3 SPDs as a coordinated set. For further information, please refer to the Furse Guide to BS EN 62305 Protection against Lightning.

Mains power protection

ESP 240/XXX Series

ESP 240/XXX Series - Technical specification

Electrical specification	ESP 240/I/TNS	ESP 240/III/TNS	ESP 240/I/TNC	ESP 240/III/TNC	ESP 240/I/TT	ESP 240/III/TT
ABB order code	7TCA085460R0019	7TCA085460R0022	7TCA085460R0018	7TCA085460R0021	7TCA085460R0020	7TCA085460R0023
Nominal voltage - Phase-Neutral U_0 (RMS)	240 V					
Maximum voltage - Phase-Neutral U_c (RMS/DC)	320 V/420 V					
Temporary Overvoltage TOV $U_T^{(1)}$	350 V					
Short circuit withstand capability	25 kA/50 Hz					
Frequency range	47-63 Hz					
Max. back-up fuse (see installation instructions)	250 A					
Leakage current (to earth)	≤ 250 A	< 2.5 mA	< 2.5 mA	< 2.5 mA	0	0
Volt free contact:	Screw terminal					
– Current rating	0.5 A					
– Nominal voltage (RMS)	250 V					
Transient specification	ESP 240/I/TNS	ESP 240/III/TNS	ESP 240/I/TNC	ESP 240/III/TNC	ESP 240/I/TT	ESP 240/III/TT
Type 1 (BS EN/EN), Class I (IEC)						
Nominal discharge current 8/20 μ s (per mode) I_n	25 kA	25 kA	25 kA	25 kA	25 kA/100 kA (N-E)	25 kA/50 kA (N-E)
Let-through voltage U_p at $I_n^{(2)}$	< 1.4 kV	< 1.4 kV	< 1.4 kV	< 1.4 kV	< 1.4 kV	< 1.4 kV
Impulse discharge current 10/350 μ s I_{imp} (per mode) ⁽²⁾	50 kA	25 kA	50 kA	25 kA	50 kA/100 kA (N-E)	25 kA/50 kA (N-E)
Let-through voltage U_p at $I_{imp}^{(2)}$	< 1.2 kV	< 1.2 kV	< 1.2 kV	< 1.2 kV	< 1.2 kV	< 1.2 kV
Let-through voltage U_p at 1.2/50 μ s (N-E, TT system)	–	–	–	–	< 1.2 kV	< 1.2 kV
Type 2 (BS EN/EN), Class II (IEC)						
Nominal discharge current 8/20 μ s (per mode) I_n	25 kA	25 kA	25 kA	25 kA	25 kA/100 kA (N-E)	25 kA/50 kA (N-E)
Let-through voltage U_p at $I_n^{(2)}$	< 1.4 kV	< 1.4 kV	< 1.4 kV	< 1.4 kV	< 1.4 kV	< 1.4 kV
Maximum discharge current I_{max} (per mode) ⁽³⁾	100 kA	100 kA	100 kA	100 kA	100 kA/160 kA (N-E)	100 kA/100 kA (N-E)
Mechanical specification	ESP 240/I/TNS	ESP 240/III/TNS	ESP 240/I/TNC	ESP 240/III/TNC	ESP 240/I/TT	ESP 240/III/TT
Temperature range	-40 to +80 °C					
Connection type	Screw terminal - maximum torque 4.5 Nm					
Conductor size (stranded)	25 mm ²					
Earth connection	Screw terminal - maximum torque 4.5 Nm					
Degree of protection (IEC 60529)	IP20					
Volt free contact	Connect via screw terminal with conductor up to 1.5 mm ² (stranded) - maximum torque 0.25 Nm					
Case material	FR Polymer UL-94 V-0					
Mounting	Indoor, 35 mm top hat DIN rail					
Weight: – Unit	0.84 kg	0.44 kg	0.44 kg	0.29 kg	0.68 kg	0.44 kg
– Packaged	0.94 kg	0.54 kg	0.54 kg	0.39 kg	0.78 kg	0.54 kg
Dimensions to DIN 43880 - HxDxW ⁽⁴⁾	90 mm x 68 mm x 72 mm (4TE)	90 mm x 68 mm x 36 mm (2TE)	90 mm x 68 mm x 36 mm (2TE)	90 mm x 68 mm x 36 mm (2TE)	90 mm x 68 mm x 72 mm (4TE)	90 mm x 68 mm x 54 mm (3TE)

⁽¹⁾ Temporary Overvoltage rating is for a maximum duration of 5 seconds tested to BS EN/EN/IEC 61643

⁽²⁾ The maximum transient voltage let-through of the protector throughout the test, phase to earth and neutral to earth

⁽³⁾ The electrical system, external to the unit, may constrain the actual current rating achieved in a particular installation

⁽⁴⁾ The remote signal contact (removable) adds 10 mm to height

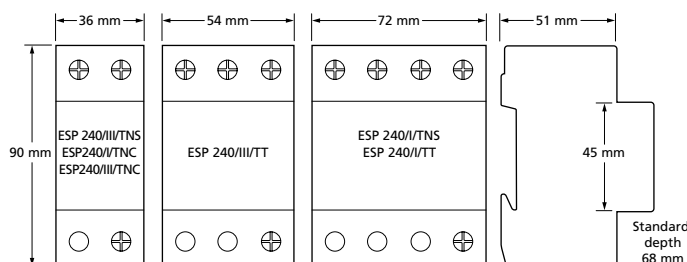

Mains power protection

ESP 415/XXX Series

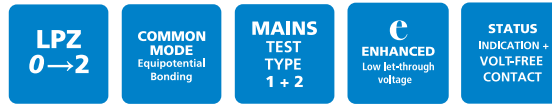

Combined Type 1 and 2 tested protector (to BS EN 61643) for use on the main distribution board, particularly where a structural Lightning Protection System (LPS) is employed, for equipotential bonding. For use at boundaries up to LPZ 0 to protect against flashover (typically the main distribution board location) through to LPZ 2 to protect electrical equipment from damage.

Features & benefits

- Enhanced protection (to IEC/BS EN 62305) offering low let-through voltage further minimizing the risk of flashover creating dangerous sparking or electric shock
- Repeated protection in lightning intense environments
- The varistor based design eliminates the high follow current (if) associated with spark gap based surge protection
- Compact, space saving design
- Indicator shows when the protector requires replacement
- Remote signal contact can indicate the protector's status through interfacing with a building management system

Application

- Use on three phase mains supplies and power distribution systems for protection against partial direct or indirect lightning strikes
- ESP 415/I/XXX versions for use with Class I or II LPS
- ESP 415/III/XXX versions for use with Class III or IV LPS; or exposed overhead three phase power lines where no LPS is fitted
- ESP 415/X/TNS versions also cover TN-C-S earthing systems

Installation

Protector to be installed in the main distribution board with connecting leads of minimal length. The protector should be fused and is suitable for attachment to a 35 mm top hat DIN rail. The diagrams below illustrate how to wire the appropriate ESP protector according to your chosen electrical system.

Accessories

Weatherproof enclosures:

WBX D4

Use with TN-S, TN-C versions and ESP 415/III/TT

WBX D8

Use with ESP 415/I/TT

Full product range order codes can be found on pages 17/8-17/9

TN-S earthing system

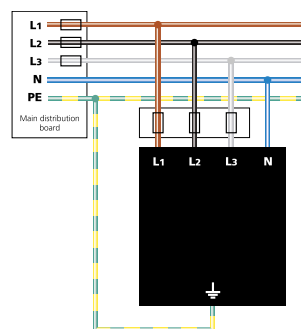

TN-C earthing system

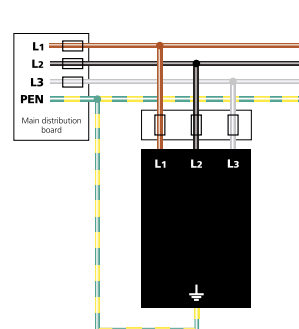

TT earthing system

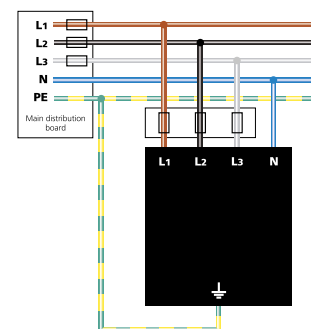

IMPORTANT: The primary purpose of lightning current or equipotential bonding mains Type 1 Surge Protective Devices (SPDs) is to prevent dangerous sparking caused by flashover to protect against the loss of human life. In order to protect electronic equipment and ensure the continual operation of systems, transient overvoltage mains Type 2 and 3 SPDs such as the ESP M1 Series or ESP D1 Series are further required, typically installed at downstream subdistribution boards feeding sensitive equipment. IEC/BS EN 62305 refers to the correct application of mains Type 1, 2 and 3 SPDs as a coordinated set. For further information, please refer to the Furse Guide to BS EN 62305 Protection against lightning.

Mains power protection

ESP 415/XXX Series

ESP 415/XXX Series - Technical specification

Electrical specification	ESP 415/I/TNS	ESP 415/III/TNS	ESP 415/I/TNC	ESP 415/III/TNC	ESP 415/I/TT	ESP 415/III/TT
ABB order code	7TCA085460R0101	7TCA085460R0103	7TCA085460R0024	7TCA085460R0025	7TCA085460R0102	7TCA085460R0026
Nominal voltage - Phase-Neutral U_0 (RMS)	240 V					
Maximum voltage - Phase-Neutral U_c (RMS/DC)	320 V/420 V					
Temporary Overvoltage TOV $U_T^{(1)}$	350 V					
Short circuit withstand capability	25 kA/50 Hz					
Frequency range	47-63 Hz					
Max. back-up fuse (see installation instructions)	250 A					
Leakage current (to earth)	≤ 250 A	< 2.5 mA	< 2.5 mA	< 2.5 mA	0	0
Volt free contact: ⁽²⁾	Screw terminal					
– Current rating	0.5 A					
– Nominal voltage (RMS)	250 V					
Transient specification	ESP 415/I/TNS	ESP 415/III/TNS	ESP 415/I/TNC	ESP 415/III/TNC	ESP 415/I/TT	ESP 415/III/TT
Type 1 (BS EN/EN), Class I (IEC)						
Nominal discharge current 8/20 μ s (per mode) I_n	25 kA	20 kA	25 kA	20 kA	25 kA/100 kA (N-E)	20 kA/50 kA (N-E)
Let-through voltage U_p at $I_n^{(2)}$	< 1.4 kV	< 1.5 kV	< 1.4 kV	< 1.5 kV	< 1.4 kV	< 1.5 kV
Impulse discharge current 10/350 μ s I_{imp} (per mode) ⁽³⁾	25 kA	12.5 kA	25 kA	12.5 kA	25 kA/100 kA (N-E)	12.5 kA/50 kA (N-E)
Let-through voltage U_p at $I_{imp}^{(2)}$	< 1.3 kV	< 1.2 kV	< 1.3 kV	< 1.2 kV	< 1.3 kV	< 1.2 kV
Let-through voltage U_p at 1.2/50 μ s (N-E, TT system)	–	–	–	–	< 1.2 kV	< 1.2 kV
Type 2 (BS EN/EN), Class II (IEC)						
Nominal discharge current 8/20 μ s (per mode) I_n	25 kA	20 kA	25 kA	20 kA	25 kA/100 kA (N-E)	20 kA/50 kA (N-E)
Let-through voltage U_p at $I_n^{(2)}$	< 1.4 kV	< 1.5 kV	< 1.4 kV	< 1.5 kV	< 1.4 kV	< 1.5 kV
Maximum discharge current I_{max} (per mode) ⁽³⁾	100 kA	50 kA	100 kA	50 kA	100 kA/160 kA (N-E)	50 kA/200 kA (N-E)
Mechanical specification	ESP 415/I/TNS	ESP 415/III/TNS	ESP 415/I/TNC	ESP 415/III/TNC	ESP 415/I/TT	ESP 415/III/TT
Temperature range	-40 to +80 °C					
Connection type	Screw terminal					
Conductor size (stranded)	25 mm ²					
Earth connection	Screw terminal					
Volt free contact	Connect via screw terminal with conductor up to 1.5 mm ² (stranded)					
Degree of protection (IEC 60529)	IP20					
Case material	FR Polymer UL-94 V-0					
Mounting	Indoor, 35 mm top hat DIN rail					
Weight: – Unit	0.84 kg	0.59 kg	0.64 kg	0.44 kg	0.9 kg	0.67 kg
– Packaged	0.94 kg	0.69 kg	0.74 kg	0.54 kg	1.0 kg	0.77 kg
Dimensions to DIN 43880 - HxDxW ⁽⁴⁾	90 mm x 68 mm x 72 mm (4TE)	90 mm x 68 mm x 72 mm (4TE)	90 mm x 68 mm x 54 mm (3TE)	90 mm x 68 mm x 54 mm (3TE)	90 mm x 68 mm x 90 mm (5TE)	90 mm x 68 mm x 72 mm (4TE)

⁽¹⁾ Temporary Overvoltage rating is for a maximum duration of 5 seconds tested to BS EN/EN/IEC 61643

⁽²⁾ The maximum transient voltage let-through of the protector throughout the test, phase to earth and neutral to earth

⁽³⁾ The electrical system, external to the unit, may constrain the actual current rating achieved in a particular installation

⁽⁴⁾ The remote signal contact (removable) adds 10 mm to height

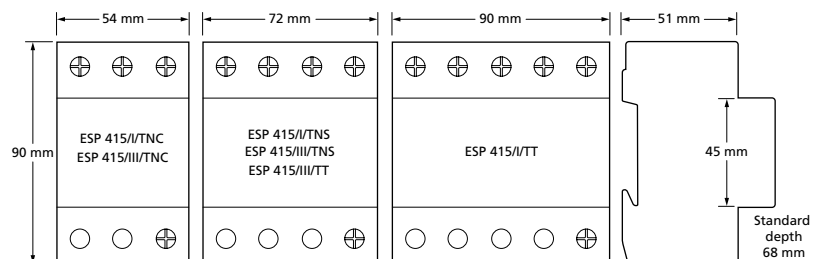

Mains power protection

ESP D1 Series (Single phase)



LPZ 0→3	FULL MODE Bonding + Equipment Protection	MAINS TEST TYPE 1 + 2 + 3	ENHANCED Low let-through voltage	ACTIVE VOLT-FREE CONTACT	3-WAY + N-E FAULT STATUS INDICATION
-------------------	--	-------------------------------------	---	---------------------------------	--

Combined Type 1, 2 and 3 tested protector (to BS EN 61643) for use on single phase mains power distribution systems primarily to protect connected electronic equipment from transient overvoltages on the mains supply, e.g. computer, communications or control equipment. For use at boundaries up to LPZ 0 to protect against flashover (typically the main distribution board location, with multiple metallic services entering) through to LPZ 3 to protect sensitive electronic equipment.

Features & benefits

- Very low let-through voltage (enhanced protection to IEC/BS EN 62305) between all sets of conductors (phase to neutral, phase to earth, neutral to earth - Full Mode protection)
- Full Mode design capable of handling partial lightning currents as well as allowing continual operation of protected equipment
- Repeated protection in lightning intense environments
- Innovative multiple thermal disconnect technology for safe disconnection from faulty or abnormal supplies (without compromising protective performance)
- Three way visual indication of protection status and advanced pre-failure warning so you need never be unprotected
- Remote indication facility allows pre-failure warning to be linked to a building management system, buzzer or light
- Changeover active volt-free contact enables the protector to be used to warn of phase loss (i.e. power failure, blown fuses etc)
- Flashing warning of potentially fatal neutral to earth supply faults (due to incorrect earthing, wiring errors or unbalanced conditions)
- Through terminal facility allows series connection on low current supplies to eliminate high additive voltage associated with connecting leads on units installed in parallel
- Compact space saving DIN housing

11

Installation

Install in parallel, within the power distribution board or directly (via fuses) on to the supply feeding equipment. Can be installed in series for low current supplies - see installation instructions. At distribution boards, the protector can be installed either on the load side of the incoming isolator, or on the closest outgoing way to the incoming supply. Connect, with very short connecting leads, to live, neutral and earth.

Accessories

Weatherproof enclosure:
WBX D4

Full product range order codes can be found on pages 17/8-17/9

Parallel connection of ESP 120 D1, ESP 240 D1 and ESP 277 D1 series to single phase supplies (fuses not shown for clarity)

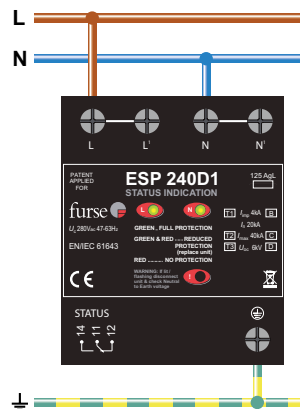

Series connection of ESP 120 D1, ESP 240 D1 and ESP 277 D1 to single phase supplies up to 125 A (fuses not shown for clarity)

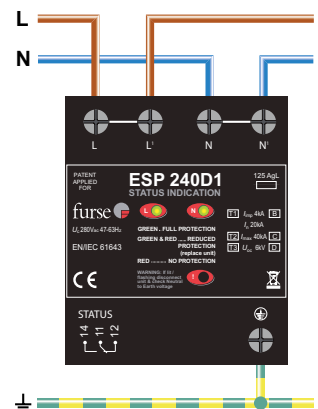

NOTE: If you desire a protector with an extra high maximum surge current use the ESP M2 or ESP M4 series. If your supply is fused at 16 Amps, or less, the in-line protectors (and their ready-boxed derivatives) may be more suitable.

Mains power protection

ESP D1 Series (Single phase)

ESP D1 Series (Single phase) - Technical specification

Electrical specification	ESP 120 D1	ESP 240 D1	ESP 277 D1
ABB order code	7TCA085460R0069	7TCA085460R0086	7TCA085460R0096
Nominal voltage - Phase-Neutral U_0 (RMS)	120 V	240 V	277 V
Maximum voltage - Phase-Neutral U_c (RMS)	150 V	280 V	350 V
Temporary Overvoltage TOV $U_T^{(1)}$	175 V	350 V	402 V
Short circuit withstand capability	25 kA/50 Hz		
Working voltage (RMS)	156-260 V	346-484 V	402-600 V
Frequency range	47-63 Hz		
Max. back-up fuse (see installation instructions)	≤ 125 A		
Leakage current (to earth)	< 250 μ A		
Indicator circuit current	< 10 mA		
Volt free contact: ⁽²⁾	Screw terminal		
– Current rating	1 A		
– Nominal voltage (RMS)	250 V		
Transient specification	ESP 120 D1	ESP 240 D1	ESP 277 D1
Type 1 (BS EN/EN), Class I (IEC)			
Nominal discharge current 8/20 μ s (per mode) I_n	20 kA		
Let-through voltage U_p at I_n	< 1 kV	< 1.3 kV	< 1.4 kV
Impulse discharge current 10/350 μ s I_{imp} (to earth) ⁽⁵⁾	4 kA		
Let-through voltage U_p at I_{imp}	< 1 kV	< 1.2 kV	< 1.3 kV
Total discharge current 10/350 μ s I_{total} (total to earth) ^(4,5)	8 kA		
Type 2 (BS EN/EN), Class II (IEC)			
Nominal discharge current 8/20 μ s (per mode) I_n	20 kA		
Let-through voltage U_p at I_n	< 1 kV	< 1.3 kV	< 1.4 kV
Maximum discharge current I_{max} (L/N-E, L-N) ⁽⁴⁾	40 kA, 40 kA		
Type 3 (BS EN/EN), Class III (IEC)			
Let-through voltage at U_{oc} of 6 kV 1.2/50 μ s and I_{sc} of 3 kA 8/20 μ s (per mode) ^(3,5)	400 V	600 V	680 V
Mechanical specification	ESP 120 D1	ESP 240 D1	ESP 277 D1
Temperature range	-40 to +80 °C		
Connection type	Screw terminal - maximum torque 4.5Nm		
Conductor size (stranded)	25 mm ²		
Earth connection	Screw terminal - maximum torque 4.5Nm		
Volt free contact	Connect via screw terminal with conductor up to 1.5 mm ² (stranded) - maximum torque 0.25 Nm		
Degree of protection (IEC 60529)	IP20		
Case material	FR Polymer UL-94 V-0		
Weight: – Unit	0.4 kg		
– Packaged	0.5 kg		
Dimensions to DIN 43880 - HxDxW ⁽⁷⁾	90 mm x 88 mm x 72 mm (4TE)		

⁽¹⁾ Temporary Overvoltage rating is for a maximum duration of 5 seconds tested to BS EN/EN/IEC 61643

⁽²⁾ Minimum permissible load is 5 V DC, 10 mA to ensure reliable operation

⁽³⁾ The maximum transient voltage let-through of the protector throughout the test ($\pm 10\%$), phase to neutral, phase to earth and neutral to earth

⁽⁴⁾ Rating is considered as the current capability of the protector for equipotential bonding near the service entrance

⁽⁵⁾ The electrical system, external to the unit, may constrain the actual current rating achieved in a particular installation

⁽⁶⁾ Combination wave test within IEC/BS EN 61643, IEEE C62.41-2002 Location Cats C1 & B3, SS 555:2010, AS/NZS 1768-2007, UL 1449 mains wire-in

⁽⁷⁾ The remote signal contact (removable) adds 10 mm to height

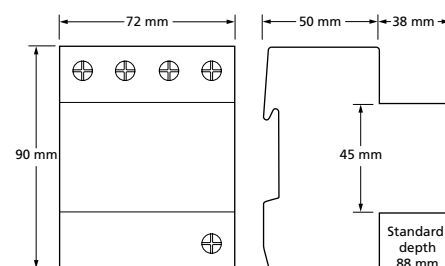

Mains power protection

ESP D1 Series (Three phase)

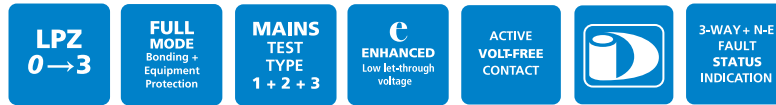

Combined Type 1, 2 and 3 tested protector (to BS EN 61643) for use on three phase mains power distribution systems primarily to protect connected electronic equipment from transient overvoltages on the mains supply, e.g. computer, communications or control equipment. Innovative remote display options allow both protector and display to be mounted in their optimum position. For use at boundaries up to LPZ 0 to protect against flashover (typically the main distribution board location, with multiple metallic services entering) through to LPZ 3 to protect sensitive electronic equipment.

Features & benefits

- Very low let-through voltage (enhanced protection to IEC/BS EN 62305) between all sets of conductors (phase to neutral, phase to earth, neutral to earth - Full Mode protection)
- Full Mode design capable of handling partial lightning currents as well as allowing continual operation of protected equipment
- Repeated protection in lightning intense environments
- Innovative multiple thermal disconnect technology for safe disconnection from faulty or abnormal supplies (without compromising protective performance)
- Three way visual indication of protection status and advanced pre-failure warning so you need never be unprotected
- ESP XXX D1R or ESP XXX D1R/LCD units (where XXX = 208, or 415, or 480) have a remote display that allows the protector to be mounted close to the incoming feed or distribution board with the display being mounted in a visible panel front (for the interconnection cable).
- ESP XXX D1/LCD or ESP XXX D1R/LCD units have backlit LCD intelligent display offering clear status information that can be rotated for side mounting to facilitate short connecting leads
- Remote indication facility allows pre-failure warning to be linked to a building management system, buzzer or light
- Changeover active volt-free contact enables the protector to be used to warn of phase loss (i.e. power failure, blown fuses etc)
- Flashing warning of potentially fatal neutral to earth supply faults (due to incorrect earthing, wiring errors or unbalanced conditions)
- Through terminal facility allows series connection on low current supplies to eliminate high additive voltage associated with connecting leads on units installed in parallel
- Compact space saving DIN housing

11

Installation

Install in parallel, within the power distribution board or directly (via fuses) on to the supply feeding equipment. Can be installed in series for low current supplies - see installation instructions. For ESP D1R or D1R/LCD units, position remote display, making sure that the cable is long enough, is unimpeded within the cabinet, and allows a minimum of 60 mm behind the

panel front (for the interconnection cable). At distribution boards, the protector can be installed either on the load side of the incoming isolator, or on the closest outgoing way to the incoming supply. Connect, with very short connecting leads, to phases, neutral and earth. For TT installations, contact Furse.

Accessories

Weatherproof enclosure:
WBX D4

ESP RLA HD-1

Spare 1 m cable assembly for ESP XXX D1R or ESP XXX D1R/LCD

ESP RLA HD-2

Spare 2 m cable assembly for ESP XXX D1R or ESP XXX D1R/LCD

ESP RLA HD-4

Spare 4 m cable assembly for ESP XXX D1R or ESP XXX D1R/LCD

Full product range order codes can be found on pages 17/8-17/9

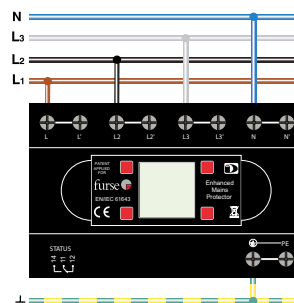

Parallel connection of ESP 415 D1, ESP 208 D1 and ESP 480 D1 series to three phase star (4 wire and earth) supplies (fuses not shown for clarity)

NOTE: If you desire a protector with an extra high maximum surge current use the ESP M2 or ESP M4 series. If your supply is fused at 32 Amps, or less, the in-line protectors (and their ready-boxed derivatives) may be more suitable.

Mains power protection

ESP D1 Series (Three phase)

ESP D1 Series (Three phase) - Technical specification

Electrical specification	ESP 208 D1 ⁽¹⁾	ESP 415 D1 ⁽¹⁾	ESP 480 D1 ⁽¹⁾
ABB order code	7TCA085460R0077	7TCA085460R0105	7TCA085460R0133
Nominal voltage - Phase-Neutral U_0 (RMS)	120 V	240 V	277 V
Maximum voltage - Phase-Neutral U_c (RMS)	150 V	280 V	350 V
Temporary Overvoltage TOV U_t ⁽²⁾	175 V	350 V	402 V
Short circuit withstand capability	25 kA/50 Hz		
Working voltage (RMS)	90-150 V	200-280 V	232-350 V
Frequency range	47-63 Hz		
Max. back-up fuse (see installation instructions)	≤ 125 A		
Leakage current (to earth)	< 250 μ A		
Indicator circuit current	< 10 mA		
Volt free contact: ⁽³⁾	Screw terminal		
– Current rating	1 A		
– Nominal voltage (RMS)	250 V		
Transient specification	ESP 208 D1	ESP 415 D1	ESP 480 D1
Type 1 (BS EN/EN), Class I (IEC)			
Nominal discharge current 8/20 μ s (per mode) I_n	20 kA		
Let-through voltage U_p at I_n	< 1 kV	< 1.3 kV	< 1.4 kV
Impulse discharge current 10/350 μ s I_{imp} (to earth) ⁽⁵⁾	4 kA		
Let-through voltage U_p at I_{imp}	< 1 kV	< 1.2 kV	< 1.3 kV
Total discharge current 10/350 μ s I_{total} (total to earth) ^(5,6)	16 kA		
Type 2 (BS EN/EN), Class II (IEC)			
Nominal discharge current 8/20 μ s (per mode) I_n	20 kA		
Let-through voltage U_p at I_n	< 1 kV	< 1.3 kV	< 1.4 kV
Maximum discharge current I_{max} (L/N-E, L-N) ⁽⁵⁾	40 kA, 40 kA		
Type 3 (BS EN/EN), Class III (IEC)			
Let-through voltage at U_{oc} of 6 kV 1.2/50 μ s and I_{sc} of 3 kA 8/20 μ s (per mode) ^(4,7)	400 V	600 V	680 V
Mechanical specification	ESP 120 D1	ESP 240 D1	ESP 277 D1
Temperature range	-40 to +80 °C		
Connection type	Screw terminal - maximum torque 4.5Nm		
Conductor size (stranded)	25 mm ²		
Earth connection	Screw terminal - maximum torque 4.5Nm		
Volt free contact	Connect via screw terminal with conductor up to 1.5 mm ² (stranded) - maximum torque 0.25 Nm		
Display connection (D1R & D1R/LCD versions)	HD-D Type 1 metre interconnection cable / 2 metre cable (ESP RLA HD-2) or 4 metre cable (ESP RLA HD-4) optional		
Degree of protection (IEC 60529)	IP20		
Case material	FR Polymer UL-94 V-0		
Weight: – Unit	0.85 kg		
– Packaged	0.95 kg		
Dimensions to DIN 43880 - HxDxW ⁽⁸⁾	90 mm x 88 mm x 144 mm (8TE)		

⁽¹⁾ Three phase series (208 V, 415 V or 480 V) include fixed (D1) or remote (D1R) LED or LCD options, e.g. ESP 415 D1, ESP 415 D1/LCD, ESP 415 D1R, ESP 415 D1R/LCD

⁽²⁾ Temporary Overvoltage rating is for a maximum duration of 5 seconds tested to IEC/BS EN 61463

⁽³⁾ Min. permissible load is 5 V DC, 10 mA to ensure reliable operation

⁽⁴⁾ The maximum transient voltage let-through of the protector throughout the test ($\pm 10\%$), phase to neutral, phase to earth and neutral to earth

⁽⁵⁾ The electrical system, external to the unit, may constrain the actual current rating achieved in a particular installation

⁽⁶⁾ Rating is considered as the current capability of the protector for equipotential bonding near the service entrance

⁽⁷⁾ Combination wave test within IEC/BS EN 61643, IEEE C62.41-2002 Location Cats C1 & B3, SS 555:2010, AS/NZS 1768-2007, UL 1449 mains wire-in

⁽⁸⁾ The remote signal contact (removable) adds 10 mm to height

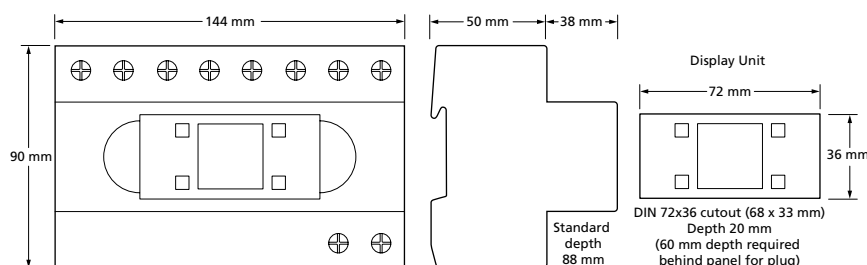

Mains power protection

ESP M2/M4 Series



LPZ
0 → 3

FULL MODE
Bonding +
Equipment
Protection

MAINS TEST TYPE
1 + 2 + 3

ENHANCED
Low let-through
voltage

ACTIVE VOLT-FREE CONTACT

3-WAY + N-E FAULT STATUS INDICATION

Combined Type 1, 2 and 3 tested protector (to BS EN 61643) for use on the main distribution board directly feeding electronic equipment such as computers, communication and control equipment, particularly where a structural Lightning Protection System (LPS) is employed. For use at boundaries up to LPZ 0 to protect against flashover (typically the main distribution board location) through to LPZ 3 to protect sensitive electronic equipment.

Features & benefits

- Very low let-through voltage (enhanced protection to IEC/BS EN 62305) between all sets of conductors (phase to neutral, phase to earth and neutral to earth - Full Mode protection)
- Full Mode design capable of handling high energy partial lightning currents as well as allowing continual operation of protected equipment
- Innovative multiple thermal disconnect technology, for safe disconnection from faulty or abnormal supplies (without compromising protective performance)
- Three way visual indication of protection status
- Advanced pre-failure warning so you need never be unprotected
- Remote indication facility allows pre-failure warning to be linked to a building management system, buzzer or light
- Changeover active volt-free contact enables the protector to be used to warn of phase loss (i.e. power failure, blown fuses, etc)
- Unique flashing warning of potentially fatal neutral to earth supply faults (caused by incorrect earthing, wiring errors or unbalanced conditions)
- Robust steel housing
- Protector base provides ultra low inductance earth bond to metal panels
- Convenient holes for flat mounting

Application

Use ESP M2 versions on main distribution board for buildings with a Class III or IV structural LPS fitted or exposed 3 phase power lines where no LPS is fitted. Use ESP M4 versions on main distribution board for buildings with a Class I or II LPS fitted.

Installation

Install in parallel, within the power distribution board, either on the load side of the incoming isolator, or on the closest outgoing way to the incoming supply. Connect, with very short connecting leads, to phase(s), neutral and earth. Phase/live connecting leads should be fused with HRC fuses, a switchfuse, MCCB or type 'C' MCB. For TT installations, contact Fursec.

Accessories

Weatherproof enclosures:

WBX M2

For use with the ESP XXX M2

WBX M4

For use with the ESP XXX M4

Full product range order codes can be found on pages 17/8-17/9

Parallel connection to three phase star (4 wire and earth) supplies (fuses not shown for clarity)

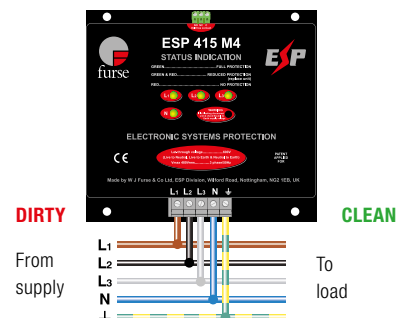

NOTE: For main distribution boards with multiple metallic services (gas, water, telecom/data lines) entering and for sub-distribution boards, the ESP M1 Series are more suited. If your supply is fused at 16 Amps, or less, the in-line protection (ESP 240 or 120-5A (or -16A) and ready-boxed derivatives) may be suitable. If you need to mount the display panel separately from the main protector unit, use the ESP XXX M2R or ESP XXX M4R.

Mains power protection

ESP M2/M4 Series

ESP M2/M4 Series - Technical specification

Electrical specification	ESP 415 M2	ESP 415 M4	ESP 480 M2	ESP 480 M4
ABB order code	7TCA085460R0119	7TCA085460R0124	7TCA085460R0138	7TCA085460R0140
Nominal voltage - Phase-Neutral U_0 (RMS)	240 V	240 V	277 V	277 V
Maximum voltage - Phase-Neutral U_c (RMS)	280 V	280 V	350 V	350 V
Temporary Overvoltage TOV $U_T^{(1)}$	350 V	350 V	402 V	402 V
Short circuit withstand capability	25 kA/50 Hz			
Working voltage (RMS)	346-484 V	346-484 V	402-600 V	402-600 V
Frequency range	47-63 Hz			
Max. back-up fuse (see installation instructions)	≤ 200 A	≤ 315 A	≤ 200 A	≤ 315 A
Leakage current (to earth)	< 500 μA	< 1000 μA	< 500 μA	< 1000 μA
Indicator circuit current	< 20 mA	< 40 mA	< 20 mA	< 40 mA
Volt free contact: ⁽²⁾	Screw terminal			
– Current rating	1 A			
– Nominal voltage (RMS)	250 V			
Transient specification	ESP 415 M2	ESP 415 M4	ESP 480 M2	ESP 480 M4
Type 1 (BS EN/EN), Class I (IEC)				
Nominal discharge current 8/20 μs (per mode) I_n	20 kA	25 kA	20 kA	25 kA
Let-through voltage U_p at $I_n^{(3)}$	< 1.3 kV	< 1.4 kV	< 1.4 kV	< 1.5 kV
Impulse discharge current 10/350 μs I_{imp} (to earth) ⁽⁴⁾	12.5 kA	25 kA	12.5 kA	25 kA
Let-through voltage U_p at $I_{imp}^{(2)}$	< 1.2 kV	< 1.3 kV	< 1.4 kV	< 1.5 kV
Total discharge current 10/350 μs /total (total to earth) ^(4,5)	50 kA	100 kA	50 kA	100 kA
Type 2 (BS EN/EN), Class II (IEC)				
Nominal discharge current 8/20 μs (per mode) I_n	20 kA	25 kA	20 kA	25 kA
Let-through voltage U_p at $I_n^{(3)}$	< 1.3 kV	< 1.4 kV	< 1.4 kV	< 1.5 kV
Maximum discharge current I_{max} (L/N-PE, L-N) ⁽⁴⁾	80 kA, 40 kA	150 kA, 40 kA	80 kA, 40 kA	150 kA, 40 kA
Type 3 (BS EN/EN), Class III (IEC)				
Let-through voltage at U_{oc} of 6 kV 1.2/50 μs and I_{sc} of 3 kA 8/20 μs (per mode) ^(3,6)	600 V	600 V	680 V	680 V
Mechanical specification	ESP 415 M2	ESP 415 M4	ESP 480 M2	ESP 480 M4
Temperature range	-40 to +80 °C			
Connection type	Screw terminal - maximum torque 2.5 Nm (ESP M2), 5.6 Nm (ESP M4)			
Conductor size (stranded)	25 mm ²	50 mm ²	25 mm ²	50 mm ²
Earth connection	Screw terminal - maximum torque 2.5 Nm (ESP M2), 5.6 Nm (ESP M4)			
Volt free contact	Connect via screw terminal with conductor up to 2.5 mm ² (stranded) - maximum torque 0.25 Nm			
Degree of protection (IEC 60529)	IP20			
Case material	Steel			
Weight: – Unit	2.35 kg	3.9 kg	2.35 kg	3.9 kg
– Packaged	2.5 kg	4.2 kg	2.5 kg	4.2 kg
Dimensions	226 mm x 204 mm x 78 mm	226 mm x 204 mm x 125 mm	226 mm x 204 mm x 78 mm	226 mm x 204 mm x 125 mm

⁽¹⁾ Temporary Overvoltage rating is for a maximum duration of 5 seconds tested to BS EN/EN/IEC 61643

⁽²⁾ Minimum permissible load is 5 V DC, 10 mA to ensure reliable operation

⁽³⁾ The maximum transient voltage let-through of the protector throughout the test ($\pm 10\%$), phase to neutral, phase to earth and neutral to earth

⁽⁴⁾ The electrical system, external to the unit, may constrain the actual current rating achieved in a particular installation

⁽⁵⁾ Rating is considered as the current capability of the protector for equipotential bonding near the service entrance

⁽⁶⁾ Combination wave test within IEC/BS EN 61643, IEEE C62.41-2002 Location Cats C1 & B3, SS 555:2010, AS/NZS 1768-2007, UL 1449 mains wire-in

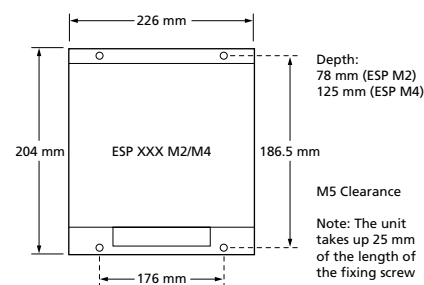

Mains power protection

ESP M1 Series



Combined Type 1, 2 and 3 tested protector (to BS EN 61643) for use on mains power distribution systems primarily to protect connected electronic equipment from transient overvoltages on the mains supply, e.g. computer, communications or control equipment. For use at boundaries up to LPZ 0 to protect against flashover (typically the main distribution board location, with multiple metallic services entering) through to LPZ 3 to protect sensitive electronic equipment.

Features & benefits

- Very low let-through voltage (enhanced protection to IEC/BS EN 62305) between all sets of conductors (phase to neutral, phase to earth, neutral to earth - Full Mode protection)
- Full mode design capable of handling partial lightning currents as well as allowing continual operation of protected equipment
- Repeated protection in lightning intense environments
- Innovative multiple thermal disconnect technology for safe disconnection from faulty or abnormal supplies (without compromising protective performance)
- Three way visual indication of protection status and advanced pre-failure warning so you need never be unprotected
- Remote indication facility allows pre-failure warning to be linked to a building management system, buzzer or light
- Changeover active volt-free contact enables the protector to be used to warn of phase loss (i.e. power failure, blown fuses etc)
- Flashing warning of potentially fatal neutral to earth supply faults (due to incorrect earthing, wiring errors or unbalanced conditions)
- Robust steel housing
- Base provides ultra-low inductance earth bond to metal panels
- Compact size for installation in the power distribution board
- ESP 120 M1 and ESP 240 M1 have Network Rail Approval PA05/02700 and PA05/01832 respectively. NRS PADS reference 086/000556 (ESP 120 M1) and 086/047149 (ESP 240 M1)

Installation

Install in parallel, within the power distribution board or directly (via fuses) on to the supply feeding equipment. At distribution boards, the protector can be installed either on the load side of the incoming isolator, or on

the closest outgoing way to the incoming supply. Connect, with very short connecting leads, to phase(s), neutral and earth. For TT installations, contact Furse.

Accessories

Weatherproof enclosures:

WBX 3

Use with single phase protectors

WBX 4

Use with three phase protectors

Full product range order codes can be found on pages 17/8-17/9

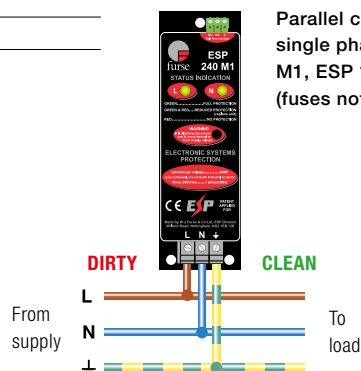

Parallel connection of single phase protectors ESP 240 M1, ESP 120 M1 or ESP 277 M1 (fuses not shown for clarity)

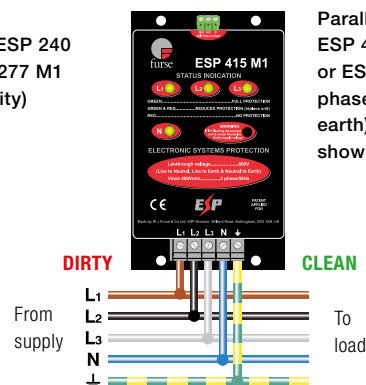

Parallel connection of ESP 415 M1, ESP 208 M1 or ESP 480 M1 to three phase star (4 wire and earth) supplies (fuses not shown for clarity)

NOTE: If you desire a protector with an extra high maximum surge current use the ESP M2 or ESP M4 series. If your supply is fused at 16 amps, or less, the in-line protectors (ESP 240 or 120-5A (or -16A) and their ready-boxed derivatives) may be more suitable. If you need to mount the display panel separately from the main protector unit, use the ESP M1R series.

Mains power protection

ESP M1 Series

ESP M1 Series - Technical specification

Electrical specification	ESP 120 M1	ESP 208 M1	ESP 240 M1	ESP 415 M1	ESP 277 M1	ESP 480 M1
ABB order code	7TCA085460R0070	7TCA085460R0089	7TCA085460R0097	7TCA085460R0078	7TCA085460R0112	7TCA085460R0136
Nominal voltage - Phase-Neutral U_0 (RMS)	120 V	120 V	240 V	240 V	277 V	277 V
Maximum voltage - Phase-Neutral U_c (RMS)	150 V	150 V	280 V	280 V	350 V	350 V
Temporary Overvoltage TOV $U_T^{(1)}$	175 V	175 V	350 V	350 V	402 V	402 V
Short circuit withstand capability	25 kA/50 Hz	25 kA/50 Hz	25 kA/50 Hz	25 kA/50 Hz	25 kA/50 Hz	25 kA/50 Hz
Working voltage (RMS)	90-150 V	156-260 V	200-280 V	346-484 V	232-350 V	402-600 V
Frequency range	47-63 Hz					
Max. back-up fuse (see installation instructions)	≤ 125 A					
Leakage current (to earth)	< 250 μ A					
Indicator circuit current	< 10 mA					
Volt free contact: ⁽²⁾	Screw terminal					
– Current rating	1 A					
– Nominal voltage (RMS)	250 V					
Transient specification	ESP 120 M1	ESP 208 M1	ESP 240 M1	ESP 415 M1	ESP 277 M1	ESP 480 M1
Type 1 (BS EN/EN), Class I (IEC)						
Nominal discharge current 8/20 μ s (per mode) I_n	20 kA					
Let-through voltage U_p at I_n	< 1 kV	< 1 kV	< 1.3 kV	< 1.3 kV	< 1.4 kV	< 1.4 kV
Impulse discharge current 10/350 μ s i_{imp} (to earth) ⁽⁴⁾	4 kA					
Let-through voltage U_p at i_{imp}	< 1 kV	< 1 kV	< 1.3 kV	< 1.3 kV	< 1.4 kV	< 1.4 kV
Total discharge current 10/350 μ s /total (total to earth) ^(4,5)	8 kA	16 kA	8 kA	16 kA	8 kA	16 kA
Type 2 (BS EN/EN), Class II (IEC)						
Nominal discharge current 8/20 μ s (per mode) I_n	20 kA					
Let-through voltage U_p at I_n	< 1 kV	< 1 kV	< 1.3 kV	< 1.3 kV	< 1.4 kV	< 1.4 kV
Maximum discharge current I_{max} (L/N-PE, L-N) ⁽⁴⁾	40 kA, 40 kA					
Type 3 (BS EN/EN), Class III (IEC)						
Let-through voltage at U_{oc} of 6 kV 1.2/50 μ s and I_{sc} of 3 kA 8/20 μ s (per mode) ^(3,6)	390 V	390 V	600 V	600 V	680 V	680 V
Mechanical specification	ESP 120 M1	ESP 208 M1	ESP 240 M1	ESP 415 M1	ESP 277 M1	ESP 480 M1
Temperature range	-40 to +80 °C					
Connection type	Screw terminal - maximum torque 1.5 Nm					
Conductor size (stranded)	16 mm ²					
Earth connection	Screw terminal - maximum torque 1.5 Nm					
Volt free contact	Connect via screw terminal with conductor up to 2.5 mm ² (stranded) - maximum torque 0.25 Nm					
Degree of protection (IEC 60529)	IP20					
Case material	Steel					
Weight: – Unit	0.6 kg	1.0 kg	0.6 kg	1.0 kg	0.6 kg	1.0 kg
– Packaged	0.7 kg	1.1 kg	0.7 kg	1.1 kg	0.7 kg	1.1 kg
Dimensions	See diagrams below					

⁽¹⁾ Temporary Overvoltage rating is for a maximum duration of 5 seconds tested to BS EN/EN/IEC 61643

⁽²⁾ Minimum permissible load is 5 V DC, 10 mA to ensure reliable operation

⁽³⁾ The maximum transient voltage let-through of the protector throughout the test ($\pm 10\%$), phase to neutral, phase to earth and neutral to earth

⁽⁴⁾ The electrical system, external to the unit, may constrain the actual current rating achieved in a particular installation

⁽⁵⁾ Rating is considered as the current capability of the protector for equipotential bonding near the service entrance

⁽⁶⁾ Combination wave test within IEC/BS EN 61643, IEEE C62.41-2002 Location Cats C1 & B3, SS 555:2010, AS/NZS 1768-2007, UL 1449 mains wire-in

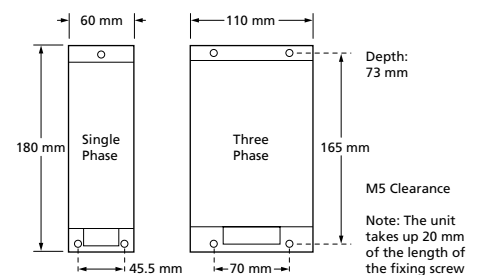

Mains power protection

ESP M1R, M2R & M4R Series



- FULL MODE**
Bonding + Equipment Protection
- MAINS TEST TYPE**
1 + 2 + 3
- REMOTE INDICATION**
LED DISPLAY
- ENHANCED**
Low let-through voltage
- ACTIVE VOLT-FREE CONTACT**
- 3-WAY + N-E FAULT STATUS INDICATION**
- LPZ**
0 → 3

Combined Type 1, 2 and 3 tested protector (to BS EN 61643) for use on mains power distribution systems primarily to protect connected electronic equipment from transient overvoltages on the mains supply, e.g. computer, communications or control equipment. Remote display allows both display and protector unit to be mounted in their optimum positions. For use at boundaries up to LPZ 0 to protect against flashover (typically the main distribution board location, with multiple metallic services entering) through to LPZ 3 to protect sensitive electronic equipment.

Features & benefits

- The remote display means the protector can be mounted close to the incoming feed or first way on the distribution board and the display in an easily visible position, e.g. on front of cabinet
- Very low let-through voltage (enhanced protection to IEC/BS EN 62305) between all sets of conductors (phase to neutral, phase to earth, neutral to earth - Full Mode protection)
- Full Mode design capable of handling partial lightning currents as well as allowing continual operation of protected equipment
- Repeated protection in lightning intense environments
- Innovative multiple thermal disconnect technology for safe disconnection from abnormal or faulty supplies
- Remote display gives three way visual indication of protection status
- Plug-in cable connections between protector and display enable easy connection (1 m cable supplied as standard)
- Advanced pre-failure warning so you need never be unprotected
- Remote indication facility allows pre-failure warning to be linked to a building management system, buzzer or light
- Changeover active volt-free contact enables the protector to be used to warn of phase loss (i.e. power failure, blown fuses, etc)
- Unique flashing warning of potentially fatal neutral to earth supply faults (caused by incorrect earthing, wiring errors or unbalanced conditions)
- Robust steel housing (protector), and sturdy ABS housing (display)
- Base provides ultra-low inductance earth bond to metal panels
- Remote display comes with integral fixings and a panel drilling template

Application

ESP M1R: main distribution board for buildings with multiple metallic services (e.g. gas, water, telecoms) and sub-distribution boards feeding sensitive equipment. ESP M2R: main distribution board for buildings with Class III or IV LPS fitted or exposed 3-ph power lines where no LPS is fitted. ESP M4R: main distribution board for buildings with a Class I

Installation

Installation of the protector unit is identical to the ESP M1, M2 or M4. Position remote display, making sure that the cable is long enough, is unimpeded within the cabinet, and allows a minimum of 60 mm behind the panel front (for the interconnection cable). For TT installations, contact Furze.

Accessories

ESP RLA-1

Spare 1 metre cable assembly

ESP RLA-2

Spare 2 metre cable assembly

ESP RLA-4

Spare 4 metre cable assembly

Parallel connection of ESP 415 M1R to three phase star (4 wire and earth) supplies (fuses not shown for clarity)

Full product range order codes can be found on pages 17/8-17/9

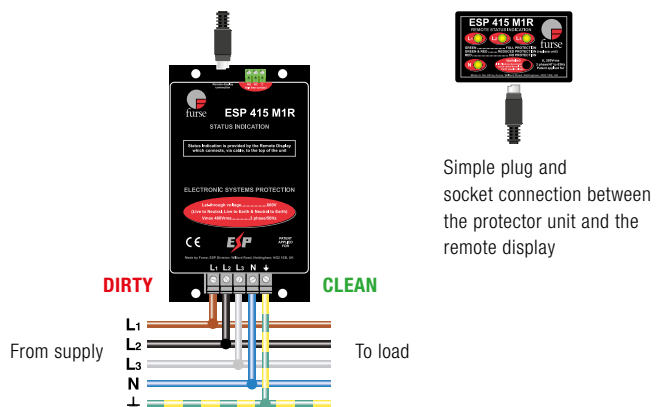

NOTE: For three phase applications where a remote display is unnecessary, use the respective ESP M1, M2 or M4 Series.

Mains power protection

ESP M1R, M2R & M4R Series

ESP M1R, M2R & M4R Series - Technical specification

Electrical specification	ESP 415 M1R	ESP 480 M1R	ESP 415 M2R	ESP 480 M2R	ESP 415 M4R	ESP 480 M4R
ABB order code	7TCA085460R0115	7TCA085460R0137	7TCA085460R0123	7TCA085460R0078	7TCA085460R0126	7TCA085460R0340
Nominal voltage - Phase-Neutral U_0 (RMS)	240 V	277 V	240 V	277 V	240 V	277 V
Maximum voltage - Phase-Neutral U_c (RMS)	280 V	350 V	280 V	350 V	280 V	350 V
Temporary Overvoltage TOV $U_T^{(1)}$	350 V	402 V	350 V	402 V	350 V	402 V
Short circuit withstand capability	25 kA/50 Hz					
Working voltage (RMS)	346-484 V	402-600 V	346-484 V	402-600 V	346-484 V	402-600 V
Frequency range	47-63 Hz					
Max. back-up fuse (see installation instructions)	≤ 125 A	≤ 125 A	≤ 200 A	≤ 200 A	≤ 315 A	≤ 315 A
Leakage current (to earth)	< 250 μ A	< 250 μ A	< 500 μ A	< 500 μ A	< 1000 μ A	< 1000 μ A
Indicator circuit current	< 10 mA	< 10 mA	< 20 mA	< 20 mA	< 40 mA	< 40 mA
Volt free contact: ⁽²⁾	Screw terminal					
– Current rating	1 A					
– Nominal voltage (RMS)	250 V					
Transient specification	ESP 415 M1R	ESP 480 M1R	ESP 415 M2R	ESP 480 M2R	ESP 415 M4R	ESP 480 M4R
Type 1 (BS EN/EN), Class I (IEC)						
Nominal discharge current 8/20 μ s (per mode) I_n	20 kA	20 kA	20 kA	20 kA	25 kA	25 kA
Let-through voltage U_p at I_n	< 1.3 kV	< 1.4 kV	< 1.3 kV	< 1.4 kV	< 1.4 kV	< 1.5 kV
Impulse discharge current 10/350 μ s I_{imp} (to earth) ⁽⁴⁾	4 kA	4 kA	12.5 kA	12.5 kA	25 kA	25 kA
Let-through voltage U_p at I_{imp} ⁽³⁾	750 V	850 V	< 1.2 kV	< 1.4 kV	< 1.3 kV	< 1.5 kV
Total discharge current 10/350 μ s I_{total} (total to earth) ^(4,5)	16 kA	16 kA	50 kA	50 kA	100 kA	100 kA
Type 2 (BS EN/EN), Class II (IEC)						
Nominal discharge current 8/20 μ s (per mode) I_n	20 kA	20 kA	20 kA	20 kA	25 kA	25 kA
Let-through voltage U_p at I_n ⁽³⁾	< 1.3 kV	< 1.4 kV	< 1.3 kV	< 1.4 kV	< 1.4 kV	< 1.5 kV
Maximum discharge current I_{max} (L/N-PE, L-N) ⁽⁴⁾	40 kA, 40 kA	40 kA, 40 kA	80 kA, 40 kA	80 kA, 40 kA	150 kA, 40 kA	150 kA, 40 kA
Type 3 (BS EN/EN), Class III (IEC)						
Let-through voltage at U_{oc} of 6 kV 1.2/50 μ s and I_{sc} of 3 kA 8/20 μ s (per mode) ^(3,6)	600 V	680 V	600 V	680 V	600 V	680 V
Mechanical specification	ESP 415 M1R	ESP 480 M1R	ESP 415 M2R	ESP 480 M2R	ESP 415 M4R	ESP 480 M4R
Temperature range	-40 to +80 °C					
Connection type	Screw terminal - maximum torque 1.5 Nm (ESP M1R), 2.5 Nm (ESP M2R), 5.6 Nm (ESP M4R)					
Conductor size (stranded)	16 mm ²	16 mm ²	25 mm ²	25 mm ²	50 mm ²	50 mm ²
Earth connection	Screw terminal - maximum torque 1.5 Nm (ESP M1R), 2.5 Nm (ESP M2R), 5.6 Nm (ESP M4R)					
Volt free contact	Connect via screw terminal with conductor up to 2.5 mm ² (stranded) - maximum torque 0.25 Nm					
Degree of protection (IEC 60529)	IP20					
Display connection	6 way 1 metre interconnection cable - 2 or 4 metre cable optional					
Case material	Unit - Steel, Display - FR Polymer UL-94 V0					
Weight: – Unit	1.0 kg	1.0 kg	2.35 kg	2.35 kg	3.9 kg	3.9 kg
– Packaged	1.1 kg	1.1 kg	2.5 kg	2.5 kg	4.2 kg	4.2 kg
Dimensions	See diagrams below					

⁽¹⁾ Temporary Overvoltage rating is for a maximum duration of 5 seconds tested to BS EN/EN/IEC 61643

⁽²⁾ Minimum permissible load is 5 V DC, 10 mA to ensure reliable operation. Under fault conditions, the remote display will go blank if the L1 phase loses power or becomes faulty. This is due to the isolation requirements needed for circuitry mounted externally to the main protector unit

⁽³⁾ The maximum transient voltage let-through of the protector throughout the test ($\pm 10\%$), phase to neutral, phase to earth and neutral to earth

⁽⁴⁾ The electrical system, external to the unit, may constrain the actual current rating achieved in a particular installation

⁽⁵⁾ Rating is considered as the current capability of the protector for equipotential bonding near the service entrance

⁽⁶⁾ Combination wave test within IEC/BS EN 61643, IEEE C62.41-2002 Location Cats C1 & B3, SS 555:2010, AS/NZS 1768-2007, UL 1449 mains wire-in

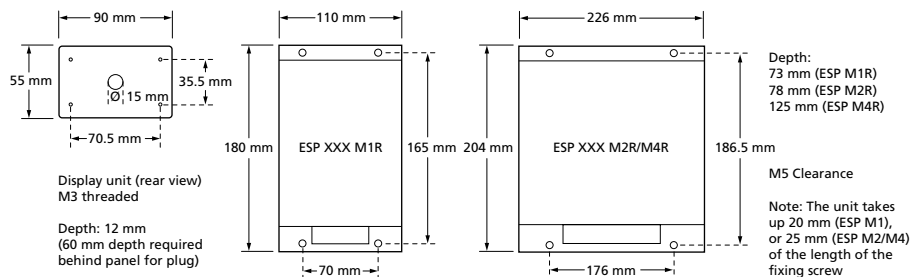

Mains power protection

ESP DC Series

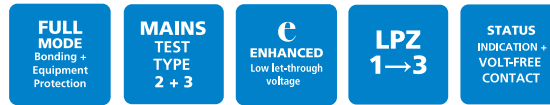

Combined Type 2 and 3 tested protector (to BS EN 61643) for use on DC systems to protect connected electronic equipment from transient overvoltages on the mains supply, e.g. control equipment. Available for 12, 24, 36 and 48 V DC systems. For use at boundaries LPZ 1 through to LPZ 3 to protect sensitive electronic equipment.

Features & benefits

- Low let-through voltage (enhanced protection to IEC/BS EN 62305) between all sets of conductors (positive to negative, positive to earth and negative to earth - Full Mode protection) allowing continuous operation of equipment
- Repeated protection in lightning intense environments
- Visual indication of protector status
- Advanced pre-failure warning so you need never be unprotected
- Remote indication facility allows pre-failure warning to be linked to a building management system, buzzer or light
- Robust steel housing
- Simple parallel connection
- Base provides ultra-low inductance earth bond to metal panels
- Compact size for installation in the power distribution board
- Maintenance free

Application

Use on DC power distribution systems to protect connected electronic equipment from transient overvoltages on the DC

Installation

Install in parallel, within the power distribution board or directly on the supply feeding the equipment. At distribution boards, the protector can be installed either on the load side of the incoming isolator, or on the closest outgoing way to the incoming supply. Connect, with very short connecting leads, to positive, negative and earth.

Accessories

Weatherproof enclosure:

WBX 3

Full product range order codes can be found on pages 17/8-17/9

Parallel connection of ESP 48 DC

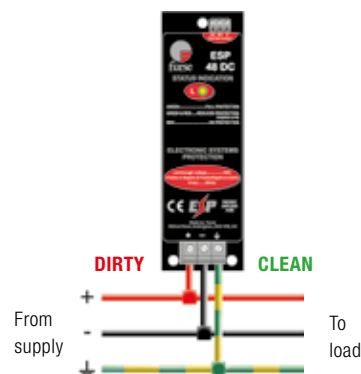

NOTE: For low current applications, the ESP H Series (4 A), ESP E Series (1.25 A) or ESP D Series (300 mA) protectors may be suitable. For protection of photovoltaic (PV) systems up to 1000 Vdc, see our ESP PV Series.

Mains power protection

ESP DC Series

ESP DC Series - Technical specification

Electrical specification	ESP 12 DC	ESP 24 DC	ESP 36 DC	ESP 48 DC
ABB order code	7TCA085460R0073	7TCA085460R0091	7TCA085460R0100	7TCA085460R0142
Nominal voltage (DC)	12 V	24 V	36 V	48 V
Maximum voltage (DC)	15 V	30 V	45 V	60 V
Working voltage (DC)	9-15 V	18-30 V	27-45 V	36-60 V
Max. back-up fuse (see installation instructions)	≤ 63 A			
Leakage current (to earth)	< 250 µA			
Indicator circuit current	< 10 mA			
Volt free contact: ⁽¹⁾	Screw terminal			
– Current rating	1 A			
– Nominal voltage (RMS)	250 V			
Transient specification	ESP 12 DC	ESP 24 DC	ESP 36 DC	ESP 48 DC
Type 2 (BS EN/EN), Class II (IEC)				
Nominal discharge current 8/20 µs (per mode) I_n	5 kA			
Let-through voltage U_p at I_n ⁽²⁾	250 V			
Maximum discharge current I_{max} (per mode) ⁽³⁾	20 kA			
Type 3 (BS EN/EN), Class III (IEC)				
Let-through voltage at U_{oc} of 6 kV 1.2/50 µs and I_{sc} of 3 kA 8/20 µs (per mode) ^(2,4)	190 V			
Mechanical specification	ESP 12 DC	ESP 24 DC	ESP 36 DC	ESP 48 DC
Temperature range	-40 to +80 °C			
Connection type	Screw terminal - maximum torque 1.5 Nm			
Conductor size (stranded)	16 mm ²			
Earth connection	Screw terminal - maximum torque 1.5 Nm			
Volt free contact	Connect via screw terminal with conductor up to 2.5 mm ² (stranded) - maximum torque 0.25 Nm			
Degree of protection (IEC 60529)	IP20			
Case material	Steel			
Weight: – Unit	0.6 kg			
– Packaged	0.7 kg			
Dimensions	180 mm x 60mm x 73 mm			

⁽¹⁾ Minimum permissible load is 5 V DC, 10 mA to ensure reliable operation

⁽²⁾ The maximum transient voltage let-through of the protector throughout the test ($\pm 10\%$) per mode

⁽³⁾ The electrical system, external to the unit, may constrain the actual current rating achieved in a particular installation

⁽⁴⁾ Combination wave test within IEC/BS EN 61643, IEEE C62.41-2002 Location Cats C1 & B3, SS 555:2010, AS/NZS 1768-2007, UL 1449 mains wire-in

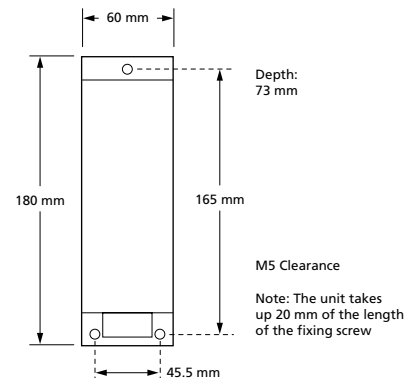

Mains power protection

ESP D/DS 10A & 32A Series (Single phase)

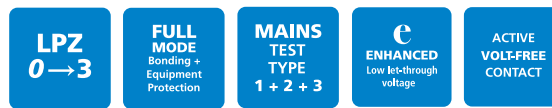

Combined Type 1, 2 and 3 tested protector (to BS EN 61643) for use on low current (up to 10 or 32 A) single phase systems to protect connected electronic equipment from transient overvoltages on the mains supply, e.g. fire/intruder alarm panels. Available for 90-150 Volts, 200-280 Volts and 232-350 Volts supplies. For use at boundary LPZ 0 through to LPZ 3 boundaries to protect sensitive electronic equipment.

Features & benefits

- Very low let-through voltage (enhanced protection to IEC/BS EN 62305) between all sets of conductors (phase to neutral, phase to earth, neutral to earth - Full Mode protection)
- Repeated protection in lightning intense environments
- Compact space saving DIN housing for easy incorporation in the protected system
- Innovative multiple thermal disconnect technology for safe disconnection from faulty or abnormal supplies (without compromising protective performance)
- Three way visual indication of protection status and advanced pre-failure warning so you need never be unprotected
- Advanced status (DS) version has remote indication facility to a BMS via an active changeover volt-free contact to show pre-failure warnings and potential phase loss (i.e. power failure, blown fuses etc), and a flashing warning of potentially fatal neutral to earth supply volts

Installation

Connect in-line with the power supply usually either within the equipment panel (or for CCTV cameras, in an enclosure close by), or on the fused connection that supplies equipment.

To protect equipment inside a building from transients entering on an outgoing feed (e.g. to CCTV cameras or to site lighting) the protector should be installed as close to where the cable leaves the building as possible.

Protectors should be installed either within an existing cabinet/cubicle or in a separate enclosure.

Accessories

Weatherproof enclosure:

WBX D4

Full product range order codes can be found on pages 17/8-17/9

Application

Use these protectors on low current mains power supplies, e.g. CCTV cameras, alarm panels, industrial battery chargers and telemetry equipment.

Connect in-line on supplies fused up to 10 A (ESP 120D-10A, ESP 120DS-10A, ESP 240D-10A, ESP 240DS-10A, ESP 277D-10A or ESP 277DS-10A) or 32 A (ESP 120D-32A, ESP 120DS-32A, ESP 240D-32A, ESP 240DS-32A, ESP 277D-32A or ESP 277DS-32A)

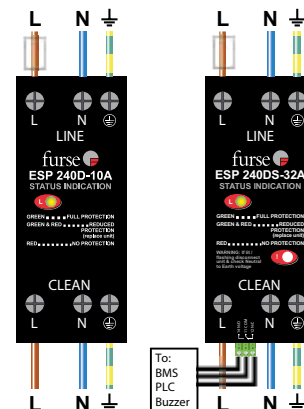

NOTE: If your supply is fused at more than 32 Amps the ESP 120 M1, ESP 240 M1 or ESP 277 M1 are suitable.

Mains power protection

ESP D/DS 10A & 32A Series (Single phase)

ESP D/DS 10A & 32A Series (Single phase) - Technical specification

	ESP 120D-10A ESP 120DS-10A	ESP 120D-32A ESP 120DS-32A	ESP 240D-10A ESP 240DS-10A	ESP 240D-32A ESP 240DS-32A	ESP 277D-10A ESP 277DS-10A	ESP 277D-32A ESP 277DS-32A
Electrical specification						
ABB order code	7TCA085460R0328 7TCA085460R0326	7TCA085460R0327 7TCA085460R0325	7TCA085460R0323 7TCA085460R0317	7TCA085460R0322 7TCA085460R0318	7TCA085460R0319 7TCA085460R0321	7TCA085460R0320 7TCA085460R0324
Nominal voltage - Phase-Neutral U_0 (RMS)	120 V		240 V		277 V	
Maximum voltage - Phase-Neutral U_c (RMS)	150 V		280 V		350 V	
Temporary Overvoltage TOV $U_T^{(1)}$	175 V		350 V		402 V	
Short circuit withstand capability	10 kA/50 Hz					
Working voltage (RMS)	90-150 V		200-280 V		232-350 V	
Frequency range	47-63 Hz					
Current rating (supply)	10 A or less	32 A or less	10 A or less	32 A or less	10 A or less	32 A or less
Max. back-up fuse (see installation instructions)	10 A	32 A	10 A	32 A	10 A	32 A
Leakage current (to earth)	Zero					
Indicator circuit current	< 10 mA					
Volt free contact (DS versions only): ⁽²⁾	Screw terminal					
– Current rating	1 A					
– Nominal voltage (RMS)	250 V					
Transient specification						
Type 1 (BS EN/EN), Class I (IEC)						
Nominal discharge current 8/20 μ s (per mode) I_n	20 kA					
Let-through voltage U_p at I_n	< 1 kV		< 1.3 kV		< 1.4 kV	
Impulse discharge current 10/350 μ s I_{imp} (L-N/E, N-E) ⁽⁴⁾	4 kA, 12.5 kA					
Let-through voltage U_p at I_{imp} ⁽³⁾	< 1 kV		< 1.2 kV		< 1.3 kV	
Total discharge current (total to earth) I_{total} ^(4,5)	6.25 kA					
Type 2 (BS EN/EN), Class II (IEC)						
Nominal discharge current 8/20 μ s (per mode) I_n	20 kA					
Let-through voltage U_p at I_n	< 1 kV		< 1.3 kV		< 1.4 kV	
Maximum discharge current I_{max} (L-N/E, N-E) ⁽⁴⁾	40 kA, 40 kA					
Type 3 (BS EN/EN), Class III (IEC)						
Let-through voltage at U_{oc} of 6 kV 1.2/50 μ s and I_{sc} of 3 kA 8/20 μ s (per mode) ^(3,6)	400 V		600 V		680 V	
Mechanical specification						
Temperature range	-40 to +80 °C					
Connection type	Screw terminal - maximum torque 0.8 Nm ⁽⁷⁾					
Conductor size (stranded)	6 mm ²					
Earth connection	Screw terminal - maximum torque 0.8 Nm ⁽⁷⁾					
Volt free contact (DS versions only)	Connect via screw terminal with conductor up to 1.5 mm ² (stranded) - maximum torque 0.25 Nm ⁽⁷⁾					
Degree of protection (IEC 60529)	IP20					
Case material	FR Polymer UL-94 V-0					
Weight: – Unit	0.23 kg					
– Packaged	0.25 kg					
Dimensions to DIN 43880 - HxDxW ⁽⁸⁾	90 mm x 75 mm x 36 mm (2TE)					

*To enclose the products to IP65, fit within a WDX D4, available from Furuse

⁽¹⁾ Temporary Overvoltage rating is for a maximum duration of 5 seconds tested to BS EN/EN/IEC 61643

⁽²⁾ Minimum permissible load is 5 V DC, 10 mA to ensure reliable operation

⁽³⁾ The maximum transient voltage let-through of the protector throughout the test ($\pm 10\%$)

⁽⁴⁾ The electrical system, external to the unit, may constrain the actual current rating achieved in a particular installation

⁽⁵⁾ Rating is considered as the current capability of the protector for equipotential bonding near the service entrance

⁽⁶⁾ Combination wave test within IEC/BS EN 61643, IEEE C62.41-2002 Location Cats C1 & B3, SS 555:2010, AS/NZS 1768-2007, UL 1449 mains wire-in

⁽⁷⁾ Torque should typically be 50% to 75% of the maximum value

⁽⁸⁾ The remote signal contact (removable) adds 10 mm to height

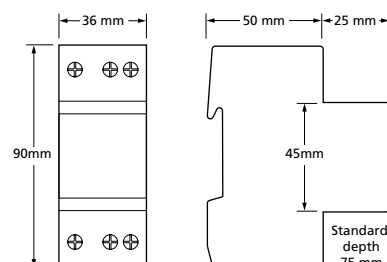

Mains power protection

ESP 5A/BX & 16A/BX Series

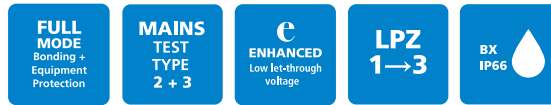

Combined Type 2 and 3 tested protector (to BS EN 61643) for use on low current (up to 5 or 16 A) single phase systems to protect connected electronic equipment from transient overvoltages on the mains supply, e.g. fire/intruder alarm panels. Protectors with /BX suffix come ready-boxed, to IP66, for use in dirty or damp environments. Available for 90-150 Volts, 200-280 Volts and 232-350 Volts supplies. For use at boundaries LPZ 1 through to LPZ 3 to protect sensitive electronic equipment.

Features & benefits

- Very low let-through voltage (enhanced protection to IEC/BS EN 62305) between all sets of conductors (phase to neutral, phase to earth, neutral to earth - Full Mode protection) allowing continuous operation of equipment
- Repeated protection in lightning intense environments
- Compact size for easy incorporation in the protected system
- Removable DIN rail foot for simple clip-on mounting to top hat DIN rails (unboxed versions)
- Colour coded terminals give a quick and easy installation check - grey for the dirty (line) end and green for the clean end
- Available ready-boxed to IP66 for use in dirty or damp environments (protectors with /BX suffix)
- Robust housing and substantial earth stud fixing holes ready for flat mounting
- Maintenance free
- ESP 240-5A/BX has Network Rail Approval PA05/02896. NRS PADS reference 087/037285

Application

Use these protectors on low current mains power supplies, e.g. CCTV cameras, alarm panels and telemetry equipment.

Installation

Connect in-line with the power supply usually either within the equipment panel (or for CCTV cameras, in an enclosure close by), or on the fused connection that supplies equipment. To protect equipment inside a building from transients entering on an outgoing feed (e.g. to CCTV cameras or to site lighting) the protector should be installed as close to where the cable leaves the building as possible. Unless ready boxed, protectors should be installed either within an existing cabinet/cubicle or in a separate enclosure.

Accessories

If several **ESP 120-5A** or 16A, **ESP 240-5A** or 16A or **ESP 277-5A** or 16A protectors are to be installed together, or if one is in use alongside Lightning Barriers for video or signal lines, these can be simultaneously mounted and earthed on a CME kit and housed in a suitable WBX enclosure.

Full product range order codes can be found on pages 17/8-17/9

Connect in-line on supplies fused up to 5 A (ESP 120-5A/BX, ESP 240-5A/BX or ESP 277-5A/BX) or 16 A (ESP 120-16A/BX, ESP 240-16A/BX or ESP 277-16A/BX). Note how the protector can also be earthed from its earth stud

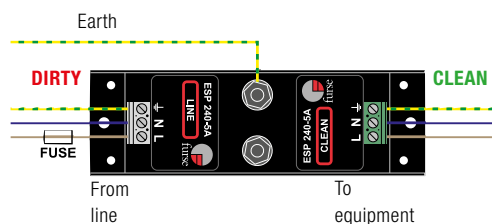

Connect in-line on supplies fused up to 5 A (ESP 120-5A, ESP 240-5A or ESP 277-5A) or 16 A (ESP 120-16A, ESP 240-16A or ESP 277-16A). Note how the protector can also be earthed from its earth stud

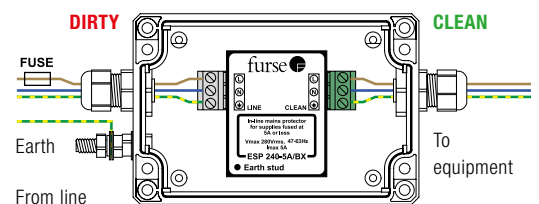

NOTE: If your supply is fused at more than 16 Amps the ESP 120 M1, ESP 240 M1 or ESP 277 M1 are suitable.

Mains power protection

ESP 5A/BX & 16A/BX Series

ESP 5A/BX & 16A/BX Series - Technical specification

Electrical specification	ESP 120-5A ESP 120-5A/BX	ESP 120-16A ESP 120-16A/BX	ESP 240-5A ESP 240-5A/BX	ESP 240-16A ESP 240-16A/BX	ESP 277-5A ESP 277-5A/BX	ESP 277-16A ESP 277-16A/BX
ABB order code	7TCA085460R0066 7TCA085460R0067	7TCA085460R0064 7TCA085460R0065	7TCA085460R0083 7TCA085460R0084	7TCA085460R0080 7TCA085460R0081	7TCA085460R0095 7TCA085460R0348	7TCA085460R0093 7TCA085460R0094
Nominal voltage - Phase-Neutral U_0 (RMS)	120 V	120 V	240 V	240 V	277 V	277 V
Maximum voltage - Phase-Neutral U_c (RMS)	150 V	150 V	280 V	280 V	350 V	350 V
Working voltage (RMS)	90-150 V	90-150 V	200-280 V	200-280 V	232-350 V	232-350 V
Frequency range	47-63 Hz					
Current rating (supply)	5 A or less	16 A or less	5 A or less	16 A or less	5 A or less	16 A or less
Max. back-up fuse (see installation instructions)	≤ 5 A	≤ 16 A	≤ 5 A	≤ 16 A	≤ 5 A	≤ 16 A
Leakage current (to earth)	< 0.5 mA					
Transient specification	120 Volt protectors		240 Volt protectors		277 Volt protectors	
Type 2 (BS EN/EN), Class II (IEC)						
Nominal discharge current 8/20 μs (per mode) I_n	5 kA					
Let-through voltage U_p at $I_n^{(1)}$	450 V	750 V	790 V			
Maximum discharge current I_{max} (per mode) ⁽²⁾	10 kA					
Type 3 (BS EN/EN), Class III (IEC)						
Let-through voltage at U_{oc} of 6 kV 1.2/50 μs and I_{sc} of 3 kA 8/20 μs (per mode) ^(1,3)	400 V	600 V	680 V			
Electrical specification	ESP 120-5A ESP 120-5A/BX	ESP 120-16A ESP 120-16A/BX	ESP 240-5A ESP 240-5A/BX	ESP 240-16A ESP 240-16A/BX	ESP 277-5A ESP 277-5A/BX	ESP 277-16A ESP 277-16A/BX
Temperature range	-40 to +80 °C			-40 to +80 °C		
Connection type	Screw terminal - maximum torque 0.5 Nm					
Conductor size (stranded)	4 mm ²					
Earth connection	Via M6 stud or earth terminal - maximum torque 0.5 Nm					
Cable glands	-			5A/BX 4.8-8 mm cable (PG9) 16A/BX 8-12 mm cable (PG13.5)		
Degree of protection (IEC 60529)	IP20			IP66		
Case material	Steel			PVC		
Weight: - Unit	0.23 kg			0.26 kg		
- Packaged	0.25 kg			0.31 kg		
Dimensions	See diagrams below					

⁽¹⁾ The maximum transient voltage let-through of the protector throughout the test ($\pm 10\%$), phase to neutral, phase to earth and neutral to earth

⁽²⁾ The electrical system, external to the unit, may constrain the actual current rating achieved in a particular installation

⁽³⁾ Combination wave test within IEC/BS EN 61643, IEEE C62.41-2002 Location Cats C1 & B3, SS 555:2010, AS/NZS 1768-2007, UL 1449 mains wire-in

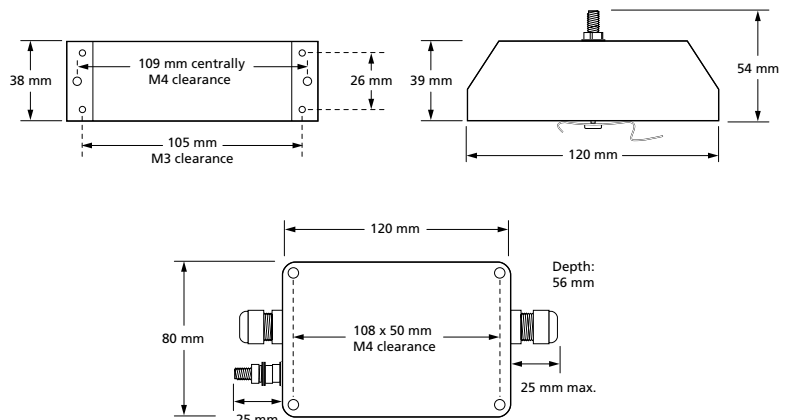

Mains power protection

ESP MC Series



**FULL
MODE**
Bonding +
Equipment
Protection

**SIGNAL/
TELECOM**
TEST CAT
D + C + B

**MAINS
TEST
TYPE**
2 + 3

e
ENHANCED
Low let-through
voltage

LPZ
0 → 3

Combined Type 2 and 3 tested protector (to BS EN 61643) with telecom or network protection options. Suitable for use on 220/230/240 Volts supplies. Available with British style (three square pin) plugs and sockets with double-pole action. For use at boundaries LPZ 1 through to LPZ 3 to protect sensitive electronic equipment.

Features & benefits

- Low let-through voltage between all sets of conductors
 - Three way visual indication of protection status
 - Protects against radio frequency interference
 - TN and Cat-5e versions can conveniently protect both mains and telecom/data lines in one unit
- Rugged, heavy duty construction
 - Bracket kit ESP MC/19BK available for rear or 19" rack mounting
 - Maintenance free

Application

ESP MC series can be used to protect all sorts of plug-in equipment, including hospital laboratory equipment, modems, fax machines and PCs.

Installation

Simply plug the ESP MC series into the mains and your equipment into the ESP MC.

Accessories

ESP MC/19BK bracket kit can be used for rear mounting, or reversed for use in 19" cabinets. All fixings supplied.

Full product range order codes can be found on pages 17/8-17/9

RFI performance

Per CISPR 17: A = 50 Ω/50 Ω sym, B = 50 Ω/50 Ω asym, C = 0.1 Ω/100 Ω sym, D = 100 Ω/0.1 Ω sym

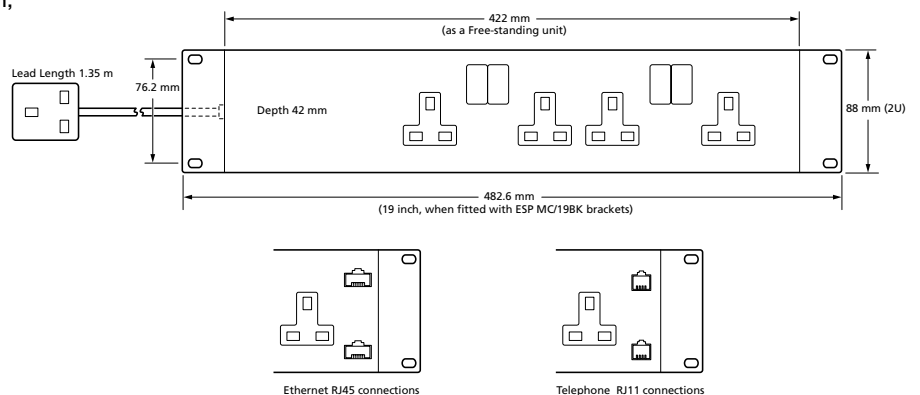
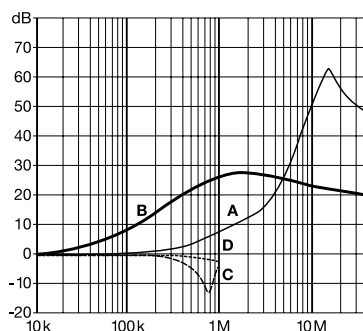

NOTE: For wire-in applications up to 16 amps, the ESP 16A/BX Series may be more suitable. For all other supplies, consider the ESP M1 Series.

Mains power protection

ESP MC Series

ESP MC Series - Technical specification

Electrical specification - mains	ESP MC	ESP MC/TN/RJ11	ESP MC/Cat-5e
ABB order code	7TCA085430R0003	7TCA085430R0005	7TCA085430R0004
Nominal voltage - Phase-Neutral U_0 (RMS)	220/230/240 V		
Maximum voltage - Phase-Neutral U_c (RMS)	280 V		
Frequency range	47-63 Hz		
Current rating (supply)	13 A		
Leakage current (to earth)	< 0.5 mA		
Electrical specification - telecom/data	ESP MC	ESP MC/TN/RJ11	ESP MC/Cat-5e
Nominal voltage	–	296 V	5 V
Maximum working voltage $U_c^{(1)}$	–	296 V	5 V ⁽²⁾
Current rating (signal)	–	300 mA	300 mA
In-line resistance (per line $\pm 10\%$)	–	4.4 Ω	1 Ω
Bandwidth (-3 dB 50 Ω system)	–	20 MHz	–
Maximum data rate	–	–	100 Mbps
Transient specification - mains	ESP MC	ESP MC/TN/RJ11	ESP MC/Cat-5e
Type 2 (BS EN/EN), Class II (IEC)			
Nominal discharge current 8/20 μ s (per mode) I_n	5 kA		
Let-through voltage U_p at $I_n^{(3)}$	850 V		
Maximum discharge current I_{max} (per mode) ⁽⁴⁾	10 kA		
Type 3 (BS EN/EN), Class III (IEC)			
Let-through voltage at U_{oc} of 6 kV 1.2/50 μ s and I_{sc} of 3 kA 8/20 μ s (per mode) ^(3,5)	680 V		
Let-through voltage at U_{oc} of 6 kV 1.2/50 μ s and I_{sc} of 500 A 8/20 (per mode) ^(3,5)	555 V		
Transient specification - telecom/data	ESP MC	ESP MC/TN/RJ11	ESP MC/Cat-5e
Let-through voltage (all conductors)⁽⁶⁾ U_p			
C2 test 4 kV 1.2/50 μ s, 2 kA 8/20 μ s to BS EN/EN/IEC 61643-21 - line to line / line to earth	–	390 V/390 V	120 V/700 V ⁽⁸⁾
C1 test 1 kV, 1.2/50 μ s, 0.5 kA 8/20 μ s to BS EN/EN/IEC 61643-21 - line to line / line to earth	–	395 V/395 V	74 V/600 V ⁽⁸⁾
B2 test 4 kV 10/700 μ s to BS EN/EN/IEC 61643-21 - line to line / line to earth	–	295 V/295 V	21 V/550 V ⁽⁸⁾
5 kV, 10/700 μ s ⁽⁷⁾ - line to line / line to earth	–	300 V/300 V	25 V/600 V ⁽⁸⁾
Maximum surge current⁽⁹⁾			
D1 test 10/350 μ s to BS EN/EN/IEC 61643-21	–	1 kA	1 kA
8/20 μ s to ITU (formerly CCITT), BS 6651:1999 Appendix C	–	10 kA	10 kA
Mechanical specification	ESP MC	ESP MC/TN/RJ11	ESP MC/Cat-5e
Temperature range	-40 °C to +80 °C		
Connection type	Via British style three square pin plug and socket to BS 1363		
Conductor size (solid)	–	RJ11	RJ45
Earth connection	Via plug and socket		
Case material	Steel		
Weight: – Unit	1.70 kg	1.75 kg	1.75 kg
– Packaged	1.75 kg	1.8 kg	1.8 kg

⁽¹⁾ Maximum working voltage (DC or AC peak) of telecom/data protection measured at <10 μ A leakage for ESP MC/TN/RJ11 and 1 mA for ESP MC/Cat-5e

⁽²⁾ Maximum working voltage is 5 V for data pairs 1/2 & 3/6

⁽³⁾ The maximum transient voltage let-through of the protector throughout the test ($\pm 10\%$), phase to neutral, phase to earth and neutral to earth

⁽⁴⁾ The electrical system, external to the unit, may constrain the actual current rating achieved in a particular installation

⁽⁵⁾ Combination wave test within IEC/BS EN 61643,

IEEE C62.41-2002 Location Cats C1 & B3, SS 555:2010, AS/NZS 1768-2007, UL 1449 mains wire-in

⁽⁶⁾ The maximum transient voltage let-through the protector throughout the test ($\pm 10\%$), line to line & line to earth. Response time < 10 ns

⁽⁷⁾ Test to IEC/BS EN 61643, IEC 61000-4-5:2006, ITU-T (formerly CCITT) K.20, K.21 and K.45, Telcordia

GR-1089-CORE, Issue 2:2002, ANSI TIA/EIA/IS-968-A:2002 (formerly FCC Part 68)

⁽⁸⁾ The interfaces used in Cat-5/5e systems incorporate an isolation transformer that inherently provides an inbuilt immunity to transients between line and earth of 1,500 Volts or more

⁽⁹⁾ The installation and connectors external to the protector may limit the capability of the protector

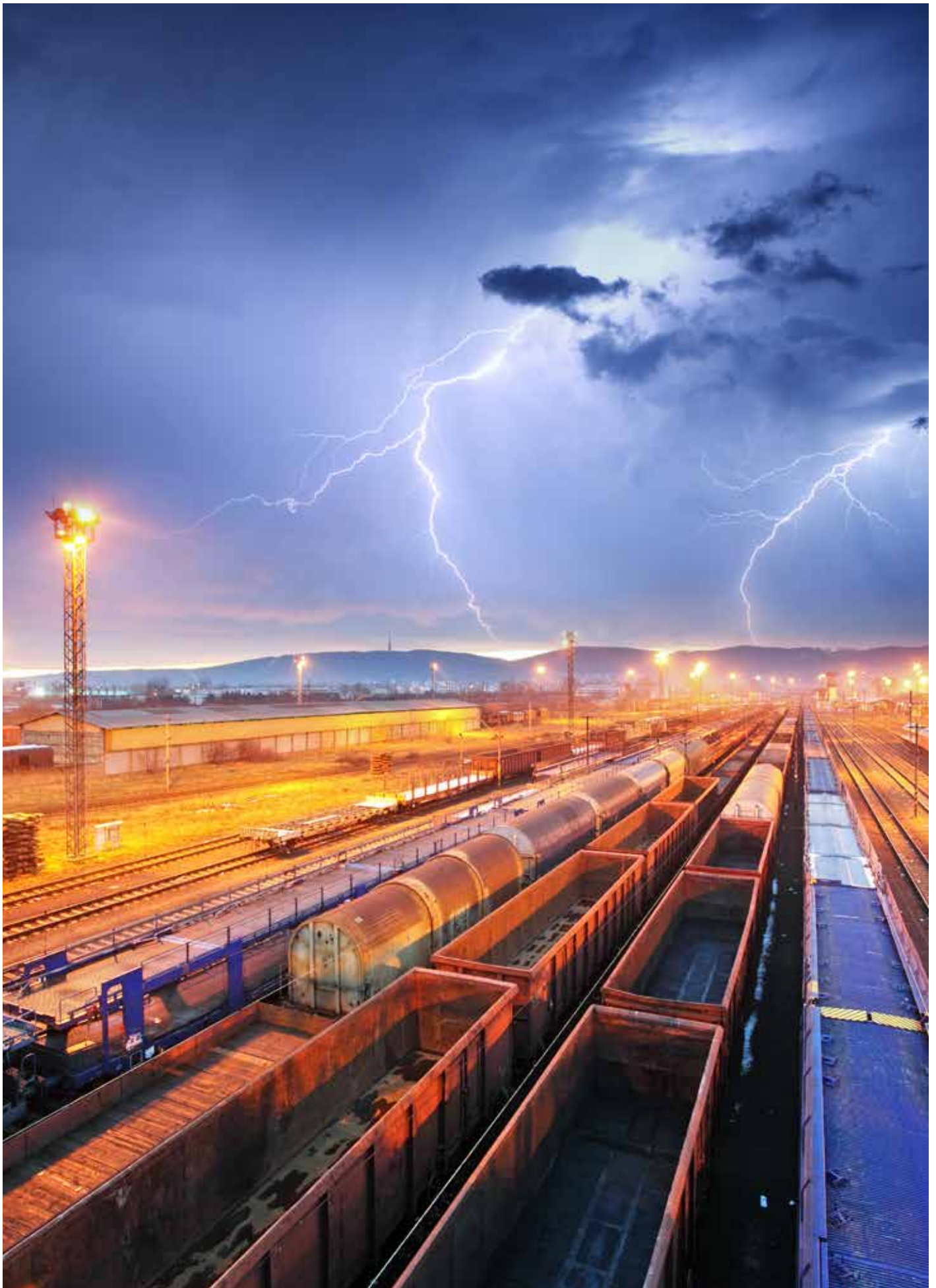

Electronic systems protection

Data & signal protection











Data & signal protection

Product selector - Data / Signal line protection	12/2
ESP D & TN Series	12/4
ESP E Series	12/6
ESP H Series	12/8
ESP D/BX Series	12/10
ESP SL Series	12/12
ESP SLX Series	12/14
ESP SL LED 4-20 mA Series	12/16
ESP SL 3-Wire Series	12/18
ESP Q & TNQ Series	12/20
ESP KS & KE Series	12/22
ESP PCB/D & PCB/TN Series	12/24
ESP PCB/E Series	12/26
ESP RTD, RTDQ & SL RTD Series	12/28
ESP RS485, RS485Q & SL RS485 Series	12/30











Data & signal protection

Product selector - Data / Signal line protection

Selection guide - data/signal systems		Installation locations
Common applications	Service entrance	Critical terminal equipment - located >20 m from service entrance
RS 232 Data interfaces - Twisted pair data protection	 ESP 15D Series ESP 15D/BX Series See pages 12/4 and 12/10	 ESP LA Series See page 13/10
Compact for limited space	 ESP SL15 Series See page 12/12	
Multiple line protection	 ESP 15Q Series See page 12/20	
RS 422 & RS 423 Data interfaces	 ESP 06E Series ESP SL06 Series See pages 12/6 and 12/12	 ESP LB Series See page 13/10
RS 485 Data interfaces	 ESP RS485 Series ESP SL RS485 Series ESP RS485Q Series See pages 12/30	 ESP LB Series See page 13/10
PBX systems terminating on LSA-Plus disconnection modules	 ESP KS Series KE Series See pages 12/22	
Computer networks, including Power over Ethernet (PoE) (see Furse Application Note AN004)	 ESP Cat-5 Series ESP Cat-6 Series See pages 13/8	 ESP LN Series See page 13/12

Protectors for specific systems

System	Protector	System	Protector
4-20 mA loops and low current telemetry systems - Compact, for limited space	 ESP SL Series ESP SL LED 4-20mA Series See pages 12/12 and 12/16	DC systems up to 110V, 4A	 ESP H Series See pages 12/8
Multiple line and PBX protection	 ESP D & Q Series ESP KS Series See pages 12/4, 12/20 and 12/22	DC systems up to 110V, 0.75 A - Compact, for limited space	 ESP SL LED Series See pages 12/12
Hazardous area (process control, fire & gas detectors, 4-20 mA loops, shut down systems)	 ESP SL X Series See pages 12/14	3-wire systems - Compact for limited space	 ESP SL/3W Series See pages 12/18
		RTD systems (see Furse Application Note AN001)	 ESP RTD Series ESP SL RTD Series ESP RTDQ Series See pages 12/28
		Data interfaces at PCB level (see Furse Application Note AN003)	 ESP PCB Series See pages 12/24
		RF radio and antenna communication systems	 ESP RF Series See pages 14/16 & 14/18

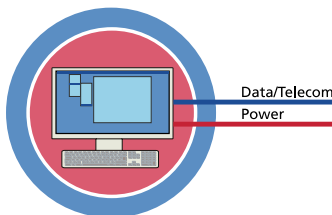

WARNING Equipment is **ONLY** protected if all incoming lines have protection fitted

Data & signal protection

ESP D & TN Series



Combined Category D, C, B tested protector (to BS EN 61643) suitable for most twisted pair signalling applications. Available for working voltages of up to 6, 15, 30, 50 and 110 Volts. ESP TN suitable for Broadband, POTS, dial-up, T1/E1, lease line and *DSL telephone applications. For use at boundaries up to LPZ 0 to protect against flashover (typically the service entrance location) through to LPZ 3 to protect sensitive electronic equipment.

Features & benefits

- Very low let-through voltage (enhanced protection to IEC/BS EN 62305) between all lines - Full Mode protection
- Full Mode design capable of handling partial lightning currents as well as allowing continual operation of protected equipment
- Repeated protection in lightning intense environments
- Low in-line resistance minimizes unnecessary reductions in signal strength
- Strong, flame retardant, ABS housing
- Supplied ready for flat mounting on base or side
- Built-in DIN rail foot for simple clip-on mounting to top hat DIN rails
- Colour coded terminals give a quick and easy installation check - grey for the dirty (line) end and green for the clean end
- Screen terminal enables easy connection of cable screen to earth
- Substantial earth stud to enable effective earthing
- Integral earthing plate for enhanced connection to earth via a CME kit
- ESP 06D and ESP 50D have PADS reference 086/000551 (ESP 06D) and 086/000553 (ESP 50D)
- ESP TN is suitable for telecommunication applications in accordance with Telcordia and ANSI Standards (see Application Note AN005)

Application

Use on twisted pair lines, e.g. those found in process control equipment, modems and computer communications interfaces.

Installation

Connect in series with the data communication or signal line either near where it enters or leaves the building or close to the equipment being protected (e.g. within its control panel). Either way, it must be very close to the system's earth star point. Install protectors either within an existing cabinet/cubicle or in a separate enclosure.

Accessories

Combined Mounting/Earthing kits:

- CME 4** Mount & earth up to 4 protectors
- CME 8** Mount & earth up to 8 protectors
- CME 16** Mount & earth up to 16 protectors
- CME 32** Mount & earth up to 32 protectors

Weatherproof enclosures:

- WBX 2/G**
For use with up to 2 protectors
- WBX 3, WBX 3/G**
For use with up to 3 protectors

WBX 4, WBX 4/GS

For use with a CME 4 and up to 4 protectors

WBX 8, WBX 8/GS

For use with a CME 8 and up to 8 protectors

WBX 16/2/G

For use with one or two CME 16 and up to 32 protectors

Full product range order codes can be found on pages 17/8-17/9

Install in series (in-line)

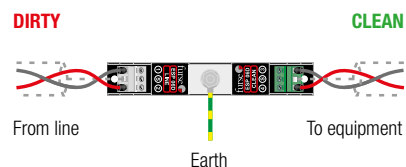

NOTE: Derivatives of these protectors are available ready-boxed to IP66, for use in damp or dirty environments. Slim Line (ESP SL), ATEX (ESP SLX) and PCB mount (ESP PCB) versions are also available. If your system requires a protector with a very low resistance or higher current, see the ESP E & H Series. Also use the ESP E Series for systems needing a higher bandwidth. Protectors for 3-wire (ESP SL/3W) and RTD (ESP RTD, ESP SL RTD) are available, as are the space saving protectors (ESP Q, ESP SL Series). The ESP KT and TN Series are additional protectors specifically for telephone lines. The ESP KS Series are protectors for data and signal lines on an LSA-PLUS module.

Data & signal protection

ESP D & TN Series

ESP D & TN Series - Technical specification

Electrical specification	ESP 06D	ESP 15D	ESP 30D	ESP 50D	ESP 110D	ESP TN
ABB order code	7TCA085400R0079	7TCA085400R0089	7TCA085400R0099	7TCA085400R0109	7TCA085400R0005	7TCA085400R0171
Nominal voltage ⁽¹⁾	6 V	15 V	30 V	50 V	110 V	–
Maximum working voltage U_c (RMS/DC) ⁽²⁾	5 V / 7.79 V	13 V / 19 V	26 V / 37.1 V	41 V / 58 V	93 V / 132 V	– / 296 V
Current rating (signal)	300 mA					
In-line resistance (per line $\pm 10\%$)	9.4 Ω	9.4 Ω	9.4 Ω	9.4 Ω	9.4 Ω	4.4 Ω
Bandwidth (-3 dB 50 Ω system)	800 kHz	2.5 MHz	4 MHz	6 MHz	9 MHz	20 MHz
Transient specification	ESP 06D	ESP 15D	ESP 30D	ESP 50D	ESP 110D	ESP TN
Let-through voltage (all conductors)⁽³⁾ Up						
C2 test 4 kV 1.2/50 μ s, 2 kA 8/20 μ s to BS EN/EN/IEC 61643-21	12.0 V	25.0 V	44.0 V	78.0 V	155 V	395 V
C1 test 1 kV, 1.2/50 μ s, 0.5 kA 8/20 μ s to BS EN/EN/IEC 61643-21	11.5 V	24.5 V	43.5 V	76.0 V	150 V	390 V
B2 test 4 kV 10/700 μ s to BS EN/EN/IEC 61643-21	10.0 V	23.0 V	42.5 V	73.0 V	145 V	298 V
5 kV, 10/700 μ s ⁽⁴⁾	10.5 V	23.8 V	43.4 V	74.9 V	150 V	300 V
Maximum surge current						
D1 test 10/350 μ s to BS EN/EN/IEC 61643-21: – Per signal wire	2.5 kA					
8/20 μ s to ITU-T K.45:2003, – Per pair	5 kA					
IEEE C62.41.2:2002: – Per signal wire	10 kA					
– Per pair	20 kA					
Mechanical specification	ESP 06D	ESP 15D	ESP 30D	ESP 50D	ESP 110D	ESP TN
Temperature range	-40 to +80 °C					
Connection type	Screw terminal - maximum torque 0.5 Nm					
Conductor size (stranded)	2.5 mm ²					
Earth connection	M6 stud					
Case material	FR Polymer UL-94 V-0					
Weight: – Unit	0.08 kg					
– Packaged (per 10)	0.85 kg					
Dimensions	See diagram below					

⁽¹⁾ Nominal voltage (RMS/DC or AC peak) measured at < 5 μ A (ESP 15D, ESP 30D, ESP 50D, ESP 110D) and <200 μ A (ESP 06D)

⁽²⁾ Maximum working voltage (RMS/DC or AC peak) measured at < 1 mA leakage (ESP 15D, ESP 30D, ESP 50D, ESP 110D), < 10 mA (ESP 06D) and < 10 μ A (ESP TN)

⁽³⁾ The maximum transient voltage let-through of the protector throughout the test ($\pm 10\%$), line to line & line to earth, both polarities. Response time < 10 ns

⁽⁴⁾ Test to IEC 61000-4-5:2006, ITU-T (formerly CCITT) K.20, K.21 and K.45, Telcordia GR-1089-CORE, Issue 2:2002, ANSI TIA/EIA/IS-968-A:2002 (formerly FCC Part 68)

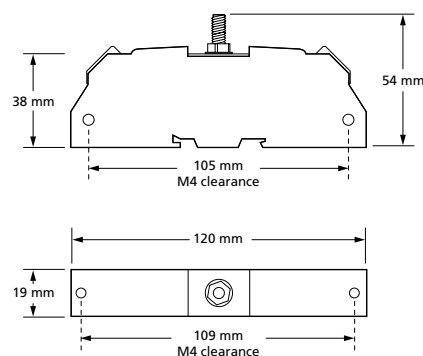

Data & signal protection

ESP E Series

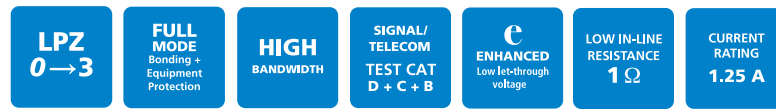

Combined Category D, C, B tested protector (to BS EN 61643) suitable for twisted pair signalling applications which require either a lower in-line resistance, an increased current or a higher bandwidth than the ESP D Series. Also suitable for DC power applications less than 1.25 Amps. Available for working voltages of up to 6, 15, 30, 50 and 110 Volts. For use at boundaries up to LPZ 0 to protect against flashover (typically the service entrance location) through to LPZ 3 to protect sensitive electronic equipment.

Features & benefits

- Very low let-through voltage (enhanced protection to IEC/BS EN 62305) between all lines - Full Mode protection
- Full Mode design capable of handling partial lightning currents as well as allowing continual operation of protected equipment
- Repeated protection in lightning intense environments
- Very low (1 Ω) in-line resistance allows resistance critical applications (e.g. alarm loops) to be protected
- High (1.25 A) maximum running current
- High bandwidth enables higher frequency (high traffic or bit rate) data communications
- Screen terminal enables easy connection of cable screen to earth
- Strong, flame retardant, ABS housing
- Built-in DIN rail foot for simple clip-on mounting to top hat DIN rails
- Colour coded terminals give a quick and easy installation check - grey for the dirty (line) end and green for clean
- Substantial earth stud to enable effective earthing
- Supplied ready for flat mounting on base or side
- Integral earthing plate for enhanced connection to earth via CME kit
- ESP 06E and ESP 15E have Network Rail Approval PA05/02047. NRS PADS reference 086/000201 (ESP 06E) and 086/000200 (ESP 15E)

Application

Use these units to protect resistance sensitive, higher frequency or running current systems, e.g. high speed digital communications equipment or systems with long signal lines.

Installation

Connect in series with the data communication or signal line either near where it enters or leaves the building or close to the equipment being protected (e.g. within its control panel). Either way, it must be very close to the system's earth star point. Install protectors either within an existing cabinet/cubicle or in a separate enclosure.

Accessories

Combined Mounting/Earthing kits:

- CME 4** Mount & earth up to 4 protectors
- CME 8** Mount & earth up to 8 protectors
- CME 16** Mount & earth up to 16 protectors
- CME 32** Mount & earth up to 32 protectors

WBX 4, WBX 4/GS

For use with a CME 4 and up to 4 protectors

WBX 8, WBX 8/GS

For use with a CME 8 and up to 8 protectors

WBX 16/2/G

For use with one or two CME 16 and up to 32 protectors

Weatherproof enclosures:

WBX 2/G

For use with up to 2 protectors

WBX 3, WBX 3/G

For use with up to 3 protectors

Full product range order codes can be found on pages 17/8-17/9

Install in series (in-line)

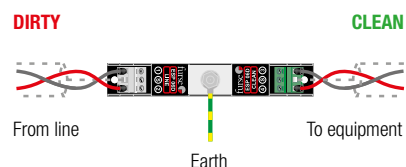

NOTE: Slim Line (ESP SL), ATEX (ESP SLX) and PCB mount (ESP PCB) are available. For many twisted pair data and signal applications, the lower cost ESP D Series may be suitable. For applications requiring higher current (1.25 A to 4 A) or ultra-low in-line resistance, the ESP H Series protectors may be more suitable. For data and signal lines on LSA-PLUS modules, use the ESP KS Series.

Data & signal protection

ESP E Series

ESP E Series - Technical specification

Electrical specification	ESP 06E	ESP 15E	ESP 30E	ESP 50E	ESP 110E
ABB order code	7TCA085400R0084	7TCA085400R0095	7TCA085400R0104	7TCA085400R0116	7TCA085400R0007
Nominal voltage ⁽¹⁾	6 V	15 V	30 V	50 V	110 V
Maximum working voltage U_c (RMS/DC) ⁽²⁾	5 V / 7.79 V	11 V / 16.7 V	25 V / 36.7 V	40 V / 56.7 V	93 V / 132 V
Current rating (signal)	1.25 A				
In-line resistance (per line $\pm 10\%$)	1.0 Ω				
Bandwidth (-3 dB 50 Ω system)	45 MHz				
Transient specification	ESP 06E	ESP 15E	ESP 30E	ESP 50E	ESP 110E
Let-through voltage (all conductors)⁽³⁾ Up					
C2 test 4 kV 1.2/50 μ s, 2 kA 8/20 μ s to BS EN/EN/IEC 61643-21	36.0 V	39.0 V	60.0 V	86.0 V	180 V
C1 test 1 kV, 1.2/50 μ s, 0.5 kA 8/20 μ s to BS EN/EN/IEC 61643-21	26.2 V	28.0 V	49.0 V	73.5 V	170 V
B2 test 4 kV 10/700 μ s to BS EN/EN/IEC 61643-21	16.0 V	25.5 V	43.5 V	65.0 V	160 V
5 kV, 10/700 μ s ⁽⁴⁾	17.0 V	26.2 V	44.3 V	65.8 V	165 V
Maximum surge current					
D1 test 10/350 μ s to BS EN/EN/IEC 61643-21: - Per signal wire	2.5 kA				
8/20 μ s to ITU-T K.45:2003, - Per signal wire	10 kA				
IEEE C62.41.2:2002: - Per pair	20 kA				
Mechanical specification	ESP 06E	ESP 15E	ESP 30E	ESP 50E	ESP 110E
Temperature range	-40 to +80 °C				
Connection type	Screw terminal - maximum torque 0.5 Nm				
Conductor size (stranded)	2.5 mm ²				
Earth connection	M6 stud				
Case material	FR Polymer UL-94 V-0				
Weight: - Unit	0.08 kg				
- Packaged (per 10)	0.85 kg				
Dimensions	See diagram below				

⁽¹⁾ Nominal voltage (RMS/DC or AC peak) measured at < 10 μ A (ESP 15E, ESP 30E, ESP 50E, ESP 110E) and < 200 μ A (ESP 06E)

⁽²⁾ Maximum working voltage (RMS/DC or AC peak) measured at < 5 mA leakage (ESP 15E, ESP 30E, ESP 50E, ESP 110E) and < 10 mA (ESP 06E)

⁽³⁾ The maximum transient voltage let-through of the protector throughout the test ($\pm 10\%$), line to line & line to earth, both polarities. Response time < 10 ns

⁽⁴⁾ Test to IEC 61000-4-5:2006, ITU-T (formerly CCITT) K.20, K.21 and K.45, Telcordia GR-1089-CORE, Issue 2:2002, ANSI TIA/EIA/IS-968-A:2002 (formerly FCC Part 68)

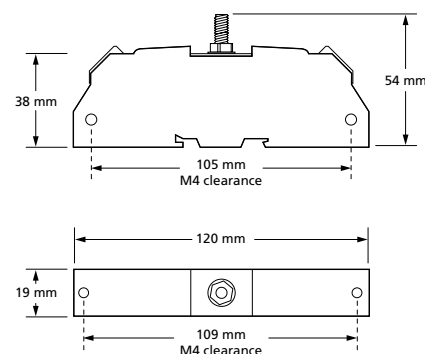

Data & signal protection

ESP H Series

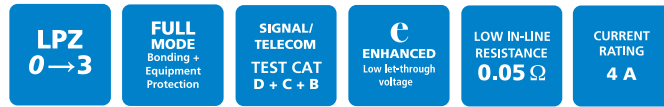

Combined Category D, C, B tested protector (to BS EN 61643) suitable for twisted pair signalling applications which require either a lower in-line resistance or an increased current than the ESP D or E Series. Also suitable for DC power applications less than 4 Amps. Available for working voltages of up to 6, 15, 30, 50 and 110 Volts. For use at boundaries up to LPZ 0 to protect against flashover (typically the service entrance location) through to LPZ 3 to protect sensitive electronic equipment.

Features & benefits

- Very low let-through voltage (enhanced protection to IEC/BS EN 62305) between all lines - Full Mode protection
- Full Mode design capable of handling partial lightning currents as well as allowing continual operation of protected equipment
- Repeated protection in lightning intense environments
- Ultra-low (< 0.05 Ω) in-line resistance allows resistance critical applications (e.g. alarm loops) to be protected
- Very high (4 A) maximum running current
- Strong, flame retardant ABS housing
- Supplied ready for flat mounting on base or side
- Built-in DIN rail foot for simple clip-on mounting to top hat DIN rails
- Colour coded terminals give a quick and easy installation check - grey for the dirty (line) end and green for clean
- Screen terminal enables easy connection of cable screen to earth
- Substantial earth stud to enable effective earthing
- Integral earth plate enables enhanced connection to earth via CME kit

Application

Use these applications to protect resistance sensitive or higher running current systems, e.g. systems with long signal lines, or DC power applications.

Installation

Connect in series with the data communication or signal line either near where it enters or leaves the building or close to the equipment being protected (e.g. within its control panel). Either way, it must be very close to the system's earth star point. Install protectors either within an existing cabinet/cubicle or in a separate enclosure.

Accessories

Combined Mounting/Earthing kits:

- CME 4** Mount & earth up to 4 protectors
- CME 8** Mount & earth up to 8 protectors
- CME 16** Mount & earth up to 16 protectors
- CME 32** Mount & earth up to 32 protectors

Weatherproof enclosures:

- WBX 2/G**
For use with up to 2 protectors
- WBX 3, WBX 3/G**
For use with up to 3 protectors

WBX 4, WBX 4/GS

For use with a CME 4 and up to 4 protectors

WBX 8, WBX 8/GS

For use with a CME 8 and up to 8 protectors

WBX 16/2/G

For use with one or two CME 16 and up to 32 protectors

Full product range order codes can be found on pages 17/8-17/9

Install in series (in-line)

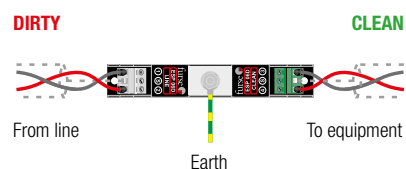

NOTE: For some data and signal applications with lower current, higher in-line resistance or higher bandwidth requirements, the ESP D or E Series protectors or the Slim Line ESP SL Series may be more suitable. If the protector is to be mounted directly onto a PCB, use the ESP PCB/**D or ESP PCB/**E protectors.

Data & signal protection

ESP H Series

ESP H Series - Technical specification

Electrical specification	ESP 06H	ESP 15H	ESP 30H	ESP 50H	ESP 110H
ABB order code	7TCA085400R0003	7TCA085400R0009	7TCA085400R0011	7TCA085400R0012	7TCA085400R0008
Nominal voltage ⁽¹⁾	6 V	15 V	30 V	50 V	110 V
Maximum working voltage U_c (RMS/DC) ⁽²⁾	5 V / 7.79 V	11 V / 16.7 V	25 V / 36.7 V	40 V / 56.7 V	93 V / 132 V
Current rating (signal)	4 A				
In-line resistance (per line $\pm 10\%$)	0.05 Ω				
Bandwidth (-3 dB 50 Ω system)	160 KHz	140 KHz	130 KHz	120 KHz	120 KHz
Transient specification	ESP 06H	ESP 15H	ESP 30H	ESP 50H	ESP 110H
Let-through voltage (all conductors)⁽³⁾ Up					
C2 test 4 kV 1.2/50 μ s, 2 kA 8/20 μ s to BS EN/EN/IEC 61643-21	12.0 V	27.5 V	46.0 V	67.0 V	150 V
C1 test 1 kV, 1.2/50 μ s, 0.5 kA 8/20 μ s to BS EN/EN/IEC 61643-21	11.0 V	26.5 V	45.0 V	66.5 V	145 V
B2 test 4 kV 10/700 μ s to BS EN/EN/IEC 61643-21	10.5 V	25.5 V	43.5 V	65.0 V	140 V
5 kV, 10/700 μ s ⁽⁴⁾	10.8 V	26.2 V	44.3 V	65.8 V	145 V
Maximum surge current					
D1 test 10/350 μ s to BS EN/EN/IEC 61643-21: - Per signal wire	2.5 kA				
8/20 μ s to ITU-T K.45:2003, - Per pair	5 kA				
IEEE C62.41.2:2002: - Per signal wire	10 kA				
- Per pair	20 kA				
Mechanical specification	ESP 06E	ESP 15E	ESP 30E	ESP 50E	ESP 110E
Temperature range	-40 to +80 °C				
Connection type	Screw terminal - maximum torque 0.5 Nm				
Conductor size (stranded)	2.5 mm ²				
Earth connection	M6 stud - maximum torque 0.5 Nm				
Case material	FR Polymer UL-94 V-0				
Weight: - Unit	0.08 kg				
- Packaged (per 10)	0.85 kg				
Dimensions	See diagram below				

⁽¹⁾ Nominal voltage (RMS/DC or AC peak) measured at < 10 μ A (ESP 15H, ESP 30H, ESP 50H, ESP 110H) and < 200 μ A (ESP 06H)

⁽²⁾ Maximum working voltage (RMS/DC or AC peak) measured at < 5 mA leakage (ESP 15H, ESP 30H, ESP 50H, ESP 110H) and < 10 mA (ESP 06H)

⁽³⁾ The maximum transient voltage let-through of the protector throughout the test ($\pm 10\%$), line to line & line to earth, both polarities. Response time < 10 ns

⁽⁴⁾ Test to IEC 61000-4-5:2006, ITU-T (formerly CCITT) K.20, K.21 and K.45, Telcordia GR-1089-CORE, Issue 2:2002, ANSI TIA/EIA/IS-968-A:2002 (formerly FCC Part 68)

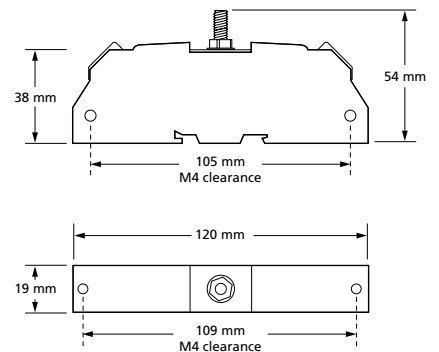

Data & signal protection

ESP D/BX Series

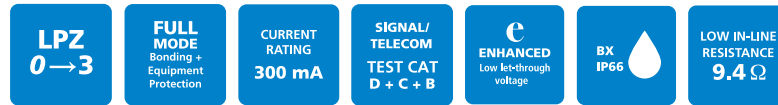

Combined Category D, C, B tested protector (to BS EN 61643) based on the ESP D Series and ESP TN but ready-boxed to IP66 for use in damp or dirty environments. Suitable for most twisted pair signalling applications. Available for working voltages of up to 6, 15, 30, 50 and 110 Volts. ESP TN suitable for Broadband, POTS, dial-up, T1/E1, lease line and *DSL telephone applications. For use at boundaries up to LPZ 0 to protect against flashover (typically the service entrance location) through to LPZ 3 to protect sensitive electronic equipment.

Features & benefits

- Very low let-through voltage (enhanced protection to IEC/BS EN 62305) between all lines - Full Mode protection
- Full Mode design capable of handling partial lightning currents as well as allowing continual operation of protected equipment
- Repeated protection in lightning intense environments
- Low in-line resistance minimizes unnecessary reductions in signal strength
- Ready-boxed to IP66 and supplied ready for flat mounting
- Available with screw terminals or with IDC terminals (by adding /I suffix to part number)
- Colour coded terminals for quick and easy installation check - grey for the dirty (line) end and green for clean
- Screen terminal enables easy connection of cable screen to earth
- Substantial earth stud to enable effective earthing
- ESP TN/BX and ESP TN/2BX are suitable for telecommunication applications in accordance with Telcordia and ANSI Standards (see Application Note AN005)
- Supplied as standard with screw terminals - for IDC terminals order part code plus /I (e.g. ESP TN/BX/I)
- ESP TN/BX has Network Rail Approval PA05/02877. NRS PADS reference 087/037286

Application

Use these ready-boxed protectors on twisted pair lines in dirty or damp environments. For two wire lines, use /BX versions. For four wire lines, use /2BX versions.

Full product range order codes can be found on pages 17/8-17/9

Installation

Connect in series with the data communication, signal or telephone line either near where it enters/leaves the building or close to the equipment being protected. Either way, it must be very close to the system's earth star point.

Install in series (in-line)

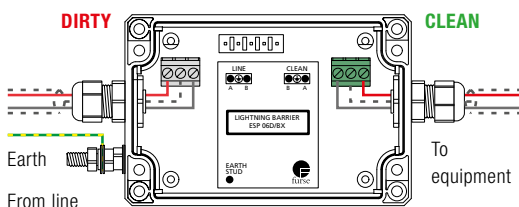

NOTE: For installation in the equipment panel, protectors which are not boxed may be more suitable. If your system requires a protector with a very low resistance, higher current or higher bandwidth use the ESP E or H Series. Unboxed protectors for 3-wire RTD systems are available - as are plug-in protectors for telephone lines and compact Slim Line protectors.

Data & signal protection

ESP D/BX Series

ESP D/BX Series - Technical specification

	ESP 06D/BX ESP 06D/2BX	ESP 15D/BX ESP 15D/2BX	ESP 30D/BX ESP 30D/2BX	ESP 50D/BX ESP 50D/2BX	ESP 110D/BX ESP 110D/2BX	ESP TN/BX ESP TN/2BX
Electrical specification						
ABB order code	7TCA085400R0081 7TCA085400R0080	7TCA085400R0091 7TCA085400R0090	7TCA085400R0101 7TCA085400R0100	7TCA085400R0113 7TCA085400R0111	7TCA085400R0006 7TCA085460R0343	7TCA085400R0175 7TCA085400R0172
Nominal voltage ⁽¹⁾	6 V	15 V	30 V	50 V	110 V	–
Maximum working voltage U_c (RMS/DC) ⁽²⁾	5 V / 7.79 V	13 V / 19 V	26 V / 37.1 V	41 V / 58 V	93 V / 132 V	– / 296 V
Current rating (signal)	300 mA					
In-line resistance (per line $\pm 10\%$)	9.4 Ω	9.4 Ω	9.4 Ω	9.4 Ω	9.4 Ω	4.4 Ω
Bandwidth (-3 dB 50 Ω system)	800 kHz	2.5 MHz	4 MHz	6 MHz	9 MHz	20 MHz
Transient specification	ESP 06D/BX ESP 06D/2BX	ESP 15D/BX ESP 15D/2BX	ESP 30D/BX ESP 30D/2BX	ESP 50D/BX ESP 50D/2BX	ESP 110D/BX ESP 110D/2BX	ESP TN/BX ESP TN/2BX
Let-through voltage (all conductors)⁽³⁾ Up						
C2 test 4 kV 1.2/50 μ s, 2 kA 8/20 μ s to BS EN/EN/IEC 61643-21	12.0 V	25.0 V	44.0 V	78.0 V	155 V	395 V
C1 test 1 kV, 1.2/50 μ s, 0.5 kA 8/20 μ s to BS EN/EN/IEC 61643-21	11.5 V	24.5 V	43.5 V	76.0 V	150 V	390 V
B2 test 4 kV 10/700 μ s to BS EN/EN/IEC 61643-21	10.0 V	23.0 V	42.5 V	73.0 V	145 V	298 V
5 kV, 10/700 μ s ⁽⁴⁾	10.5 V	23.8 V	43.4 V	74.9 V	150 V	300 V
Maximum surge current						
D1 test 10/350 μ s to BS EN/EN/IEC 61643-21: – Per signal wire	2.5 kA					
8/20 μ s to ITU-T K.45:2003, IEEC C62.41.2:2002: – Per pair	5 kA					
	10 kA					
	20 kA					
Mechanical specification	ESP 06D/BX ESP 06D/2BX	ESP 15D/BX ESP 15D/2BX	ESP 30D/BX ESP 30D/2BX	ESP 50D/BX ESP 50D/2BX	ESP 110D/BX ESP 110D/2BX	ESP TN/BX ESP TN/2BX
Temperature range	-40 to +80 °C					
Connection type	Screw terminal - for IDC terminal use part number with /I - maximum torque 0.5 Nm					
Conductor size (stranded)	1.5 mm ²					
Earth connection	M6 stud - maximum torque 0.5 Nm					
Cable glands	Accommodate 2.3-6.7 mm diameter cable (PG7)					
Degree of protection (IEC 60529)	M6 stud					
Case material	PVC					
Weight: – Unit	0.3 kg					
– Packaged (per 10)	0.35 kg					
Dimensions	See diagram below					

⁽¹⁾ Nominal voltage (RMS/DC or AC peak) measured at < 10 μ A (ESP 15D/BX, ESP 15D/2BX, ESP 30D/BX, ESP 30D/2BX, ESP 50D/BX, ESP 50D/2BX, ESP 110D/BX, ESP 110D/2BX) and < 200 μ A (ESP 06D/BX & ESP 06D/2BX)

⁽²⁾ Maximum working voltage (RMS/DC or AC peak) measured at < 1 mA leakage (ESP 15D/BX, ESP 15D/2BX, ESP 30D/BX, ESP 30D/2BX, ESP 50D/BX, ESP 50D/2BX, ESP 110D/BX, ESP 110D/2BX), < 10 mA (ESP 06D/BX, ESP 06D/2BX) and < 10 μ A (ESP TN/BX, ESP TN/2BX)

⁽³⁾ The maximum transient voltage let-through of the protector throughout the test ($\pm 10\%$), line to line & line to earth, both polarities. Response time < 10 ns

⁽⁴⁾ Test to IEC 61000-4-5:2006, ITU-T (formerly CCITT) K.20, K.21 and K.45, Telcordia GR-1089-CORE, Issue 2:2002, ANSI TIA/EIA/IS-968-A:2002 (formerly FCC Part 68)

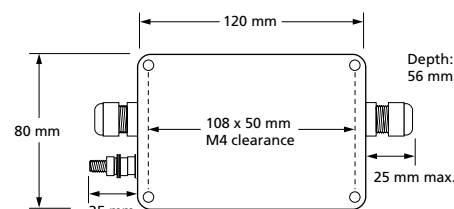

Data & signal protection

ESP SL Series



LPZ 0→3	FULL MODE Bonding + Equipment Protection	LED OPTIONAL INDICATION	SIGNAL/ TELECOM TEST CAT D + C + B	e ENHANCED Low let-through voltage
REPLACEABLE PROTECTION MODULE	LOW IN-LINE RESISTANCE 1 Ω	CURRENT RATING 750 mA	HIGH BANDWIDTH	ULTRA SLIM 7 mm WIDTH

Combined Category D, C, B tested protector (to BS EN 61643) suitable for twisted pair signalling applications which require either a lower in-line resistance, an increased current and/or higher bandwidth. Also suitable for DC power applications less than 0.75 Amps. Available for working voltages of up to 6, 15, 30, 50 and 110 Volts. For use at boundaries up to LPZ 0 to protect against flashover (typically the service entrance location) through to LPZ 3 to protect sensitive electronic equipment.

Features & benefits

- Very low let-through voltage (enhanced protection to IEC/BS EN 62305) between all lines - Full Mode protection
- Full Mode design capable of handling partial lightning currents as well as allowing continual operation of protected equipment
- Repeated protection in lightning intense environments
- Ultra slim 7 mm width ideal for compact protection of large numbers of lines (e.g. process control installations)
- Optional LED status indication versions available for low current DC power applications - add L suffix to part number - e.g. ESP SL30L
- Two stage removable protection module with simple quick release mechanism allowing partial removal for easy line commissioning and maintenance as well as full removal for protection replacement
- Strong, flame retardant, polycarbonate housing
- High (750 mA) maximum running current
- High bandwidth enables higher frequency (high traffic or bit rate) data communications
- Screen terminal enables easy connection of cable screen to earth
- Suitable for earthed or isolated screen systems - add /I suffix to part number for versions that require isolated screens - e.g. ESP SL30/I
- Built-in innovative DIN rail foot with locking feature for simple positioning and clip-on mounting to top hat DIN rails
- 4 mm² terminals allow for larger cross section wiring, stranded wires terminated with ferrules or fitting two wires into a single terminal
- Convenient earthing through DIN foot and/or earth terminal
- Very low (1 Ω) in-line resistance allows resistance critical applications (e.g. alarm loops) to be protected

12 Application

Use these protectors where installation space is at a premium and large numbers of lines require protection (e.g. process control, high speed digital communication equipment or systems with long signal lines).

Installation

Connect in series with the data communication or signal line either near where it enters or leaves the building or close to the equipment being protected (e.g. within its control panel). Either way, it must be very close to the system's earth star point. Install protectors either within an existing cabinet/cubicle or in a separate enclosure.

Accessories

Replacement modules:

ESP SLXX/M

Standard module replacement where XX is voltage rating (06, 15, 30, 50 or 110)

ESP SLXL/M

LED module replacement where XX is voltage rating, as above

ESP SL/B

Base replacement (common for standard and LED modules)

ESP SL/I/B

Base replacement with isolated screen from earth

Full product range order codes can be found on pages 17/8-17/9

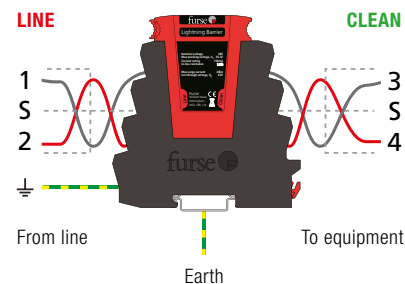

NOTE: The ESP SL 'Slim Line' Series is also available for protection of 3-wire, RS 485 and RTD applications (ESP SL/3W, ESP SL RS485 & ESP SL RTD). The ESP SL X Series has approvals for use in hazardous areas.

Data & signal protection

ESP SL Series

ESP SL Series - Technical specification

Electrical specification	ESP SL06	ESP SL15	ESP SL30	ESP SL50	ESP SL110	ESP SL TN
ABB order code	7TCA085400R0058	7TCA085400R0063	7TCA085400R0067	7TCA085400R0074	7TCA085400R0061	7TCA085400R0195
Nominal voltage ⁽¹⁾	6 V	15 V	30 V	50 V	110 V	–
Maximum working voltage U_c (RMS/DC) ⁽²⁾	5 V / 7.79 V	11 V / 16.7 V	25 V / 36.7 V	40 V / 56.7 V	93 V / 132 V	– / 296 V
Current rating (signal)	750 mA					
In-line resistance (per line $\pm 10\%$)	1.0 Ω					
Bandwidth (-3 dB 50 Ω system)	45 MHz	45 MHz	45 MHz	45 MHz	45 MHz	20 MHz
Transient specification	ESP SL06	ESP SL15	ESP SL30	ESP SL50	ESP SL110 E	SP SL TN
Let-through voltage (all conductors)⁽³⁾ Up						
C2 test 4 kV 1.2/50 μ s, 2 kA 8/20 μ s to BS EN/EN/IEC 61643-21	36.0 V	38.4 V	63.0 V	90.3 V	185 V	395 V
C1 test 1 kV, 1.2/50 μ s, 0.5 kA 8/20 μ s to BS EN/EN/IEC 61643-21	26.2 V	29.4 V	51.3 V	77.2 V	175 V	390 V
B2 test 4 kV 10/700 μ s to BS EN/EN/IEC 61643-21	16.0 V	26.8 V	45.4 V	68.3 V	165 V	298 V
5 kV, 10/700 μ s ⁽⁴⁾	17.0 V	27.5 V	46.3 V	69.1 V	170 V	300 V
Maximum surge current						
D1 test 10/350 μ s to BS EN/EN/IEC 61643-21: – Per signal wire	1.25 kA					
8/20 μ s to ITU-T K.45:2003, – Per signal wire	10 kA					
IEEE C62.41.2:2002: – Per pair	20 kA					
– Per pair	2.5 kA					
	20 kA					
Mechanical specification	ESP SL06	ESP SL15	ESP SL30	ESP SL50	ESP SL110	ESP SL TN
Temperature range	-40 to +80 °C					
Connection type	Screw terminal - maximum torque 0.8 Nm					
Conductor size (stranded)	4 mm ²					
Earth connection	Via DIN rail or 4 mm ² earth terminal - maximum torque 0.8 Nm					
Case material	FR Polymer UL-94 V-0					
Weight: – Unit	0.08 kg					
– Packaged (per 10)	0.85 kg					
Dimensions	See diagram below					

⁽¹⁾ Nominal voltage (RMS/DC or AC peak) measured at < 10 μ A (ESP SL15, ESP SL30, ESP SL50, ESP SL110 and LED variants) and < 200 μ A (ESP SL06 and ESP SL06L)

⁽²⁾ Maximum working voltage (RMS/DC or AC peak) measured at < 1 mA leakage

⁽³⁾ The maximum transient voltage let-through of the protector throughout the test ($\pm 10\%$), line to line & line to earth, both polarities. Response time < 10 ns

⁽⁴⁾ Test to IEC 61000-4-5:2006, ITU-T (formerly CCITT) K.20, K.21 and K.45, Telcordia GR-1089-CORE, Issue 2:2002, ANSI TIA/EIA/IS-968-A:2002 (formerly FCC Part 68)

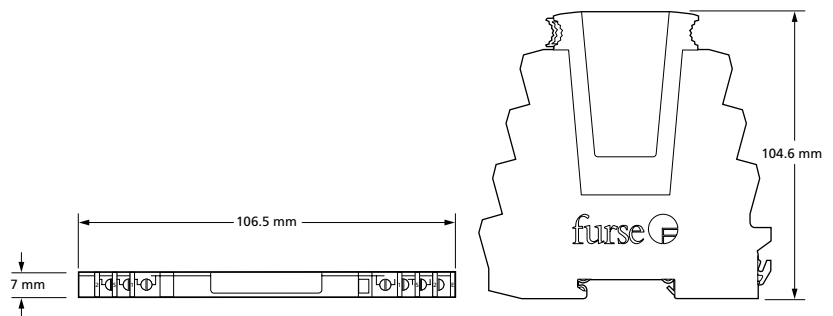

Data & signal protection

ESP SL X Series

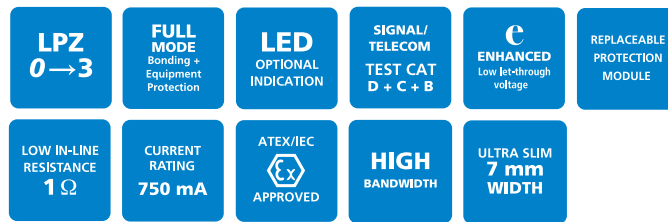

Combined Category D, C, B tested protector (to BS EN 61643) suitable for twisted pair signalling applications within hazardous environments (ATEX/IECEx approved). Available for working voltages of up to 15 and 30 Volts. For use at boundaries up to LPZ 0 to protect against flashover through to LPZ 3 to protect sensitive electronic equipment.

Features & benefits

- Approved for use in hazardous environments for the protection of Intrinsically Safe circuits (Classification: II 2(1) G, Ex ia (ia Ga) IIC T4 Gb)
- Very low let-through voltage (enhanced protection to IEC/BS EN 62305) between all lines - Full Mode protection
- Full Mode design capable of handling partial lightning currents as well as allowing continual operation of protected equipment
- Repeated protection in lightning intense environments
- Ultra slim 7 mm width ideal for compact protection of large numbers of lines (e.g. process control installations)
- Optional LED status indication versions available for low current DC power applications
- Negligible self-capacitance and self-inductance offering minimal interference when protecting Intrinsically Safe circuits
- Very low (1 Ω) in-line resistance allows resistance critical applications (e.g. alarm loops) to be protected
- High (750 mA) maximum running current
- High bandwidth enables higher frequency (high traffic or bit rate) data communications
- Screen terminal enables easy connection of cable screen to earth
- Suitable for earthed or isolated screen systems - add /I suffix to part number for versions that require isolated screens
- Built-in innovative DIN rail foot with locking feature for simple positioning and clip-on mounting to top hat DIN rails
- 4 mm² terminals allow for larger cross section wiring, stranded wires terminated with ferrules or fitting two wires into a single terminal
- Approval references for ESP SL X Series: IECEx SIR 10.0030X, Sira 10ATEX2063X

12

Application

Use these protectors in hazardous environments where installation space is at a premium and large numbers of lines require protection (e.g. process control, 4-20 mA loops, fire and gas detectors and shut-down systems). Suitable for high speed digital communication equipment or systems with long signal lines. See Furse Application Note AN013.

Accessories

Replacement modules:

ESP SL15X/M, ESP30X/M

Standard module replacement for 15 and 30 V protectors respectively

ESP SL15XL/M, ESP30XL/M

LED module replacement for 15 and 30 V protectors respectively

ESP SLX/B

Base replacement (common for standard and LED modules)

ESP SLX/I/B

Base replacement with isolated screen from earth

Full product range order codes can be found on pages 17/8-17/9

Installation

Connect in series with the data communication or signal line either near where it enters or leaves the building or close to the equipment being protected (e.g. within its control panel). Either way, it must be very close to the system's earth star point. Install protectors either within an existing cabinet/cubicle or in a separate enclosure.

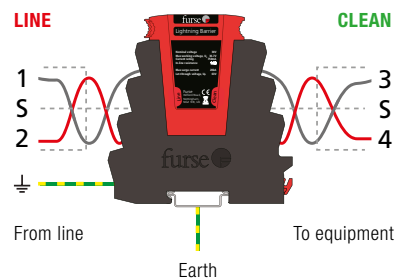

NOTE: Use the standard ESP SL 'Slim Line' Series for non-hazardous areas. The ESP SL Series is also available for protection of 3-wire, RS 485, RTD & telecommunication applications (ESP SL/3W, ESP SL RS485, ESP SL RTD & ESP SL TN).

Data & signal protection

ESP SL X Series

ESP SL X Series - Technical specification

Electrical specification	ESP SL15X	ESP SL30X
ABB order code	7TCA085400R0065	7TCA085400R0071
Nominal voltage ⁽¹⁾	15 V	30 V
Maximum working voltage U_c (RMS/DC) ⁽²⁾	11 V / 16.7 V	25 V / 36.7 V
Current rating (signal)	750 mA	
In-line resistance (per line $\pm 10\%$)	1.0 Ω	
Bandwidth (-3 dB 50 Ω system)	45 MHz	
Intrinsically safe specification	ESP SL15X	ESP SL30X
Maximum voltage U_i	30 V	
Maximum power P_i :		
- Per -40 °C < Ta < 40 °C	1.3 W	
- Per -40 °C < Ta < 60 °C	1.2 W	
- Per -40 °C < Ta < 80 °C	1.0 W	
Capacitance C_i	0 μ F	
Inductance L_i	0 μ H	
Certificate number	IECEX SIR 10.0030X, Sira 10ATEX2063X	
Classification	Ex II 2 (1) G, Ex ia (ia Ga) IIC T4 Gb	
Transient specification	ESP SL15X	ESP SL30X
Let-through voltage (all conductors)⁽³⁾ U_p		
C2 test 4 kV 1.2/50 μ s, 2 kA 8/20 μ s to BS EN/EN/IEC 61643-21	38.4 V	63.0 V
C1 test 1 kV, 1.2/50 μ s, 0.5 kA 8/20 μ s to BS EN/EN/IEC 61643-21	29.4 V	51.3 V
B2 test 4 kV 10/700 μ s to BS EN/EN/IEC 61643-21	26.8 V	45.4 V
5 kV, 10/700 μ s ⁽⁴⁾	27.5 V	46.3 V
Maximum surge current		
D1 test 10/350 μ s to BS EN/EN/IEC 61643-21:		
- Per signal wire	1.25 kA	
- Per pair	2.5 kA	
8/20 μ s to ITU-T K.45:2003, IEEE C62.41.2:2002:		
- Per signal wire	10 kA	
- Per pair	20 kA	
Mechanical specification	ESP SL15X	ESP SL30X
Temperature range	-40 to +80 °C	
Connection type	Screw terminal - maximum torque 0.8 Nm	
Conductor size (stranded)	4 mm ²	
Earth connection	Via DIN rail or 4 mm ² earth terminal - maximum torque 0.8 Nm	
Case material	FR Polymer UL-94 V-0	
Weight:		
- Unit	0.08 kg	
- Packaged (per 10)	0.85 kg	
Dimensions	See diagram below	

⁽¹⁾ Nominal voltage (RMS/DC or AC peak) measured at < 10 μ A

⁽²⁾ Maximum working voltage (RMS/DC or AC peak) measured at < 1 mA leakage

⁽³⁾ The maximum transient voltage let-through of the protector throughout the test ($\pm 10\%$), line to line & line to earth, both polarities. Response time < 10 ns

⁽⁴⁾ Test to IEC 61000-4-5:2006, ITU-T (formerly CCITT) K.20, K.21 and K.45, Telcordia GR-1089-CORE, Issue 2:2002, ANSI TIA/EIA/IS-968-A:2002 (formerly FCC Part 68)

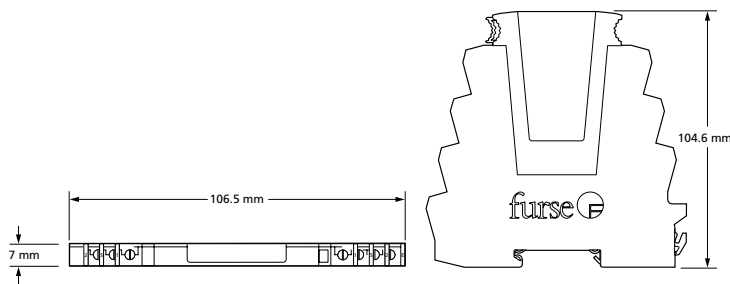

Data & signal protection

ESP SL LED 4-20 mA Series



LPZ 0→3	FULL MODE Bonding + Equipment Protection	REPLACEABLE PROTECTION MODULE	SIGNAL/ TELECOM TEST CAT D + C + B	ENHANCED Low let-through voltage	LOW IN-LINE RESISTANCE 1 Ω
CURRENT RATING 75 mA	ULTRA SLIM 7 mm WIDTH	LED INDICATION			

Combined Category D, C, B tested protector (to BS EN 61643) suitable for twisted pair 4-20 mA loop systems with innovative LED protector status indication. For use at boundaries up to LPZ 0 to protect against flashover (typically the service entrance location) through to LPZ 3 to protect sensitive electronic equipment (e.g. transmitters, monitors, controllers).

Features & benefits

- Very low let-through voltage (enhanced protection to IEC/BS EN 62305) between all lines - Full Mode protection
- Full Mode design capable of handling partial lightning currents as well as allowing continual operation of protected equipment
- Repeated protection in lightning intense environments
- Innovative LED indication of protection status provides easy visual checking and quick maintenance
- Ultra slim 7 mm width ideal for compact protection of large numbers of lines (e.g. process control installations)
- Two stage removable protection module with simple quick release mechanism allowing partial removal for easy line commissioning and maintenance as well as full removal for protection replacement
- Very low (1 Ω) in-line resistance for minimal system interference
- High (75 mA) maximum running current - can also be used on 10-50 mA systems (e.g. process control)
- Screen terminal enables easy connection of cable screen to earth
- Strong, flame retardant, polycarbonate housing
- Built-in innovative DIN rail foot with locking feature for simple positioning and clip-on mounting to top hat DIN rails
- 4 mm² terminals allow for larger cross section wiring, stranded wires terminated with ferrules or fitting two wires into a single terminal
- Convenient earthing through DIN foot and/or earth terminal

Application

Use these protectors on 4-20 mA loop systems - ideal where installation space is at a premium and large numbers of lines require protection, or for systems with long signal lines.

Installation

Connect in series with the 4-20 mA current loop either near where it enters or leaves the building or close to the equipment being protected (e.g. within its control panel). Either way, it must be very close to the system's earth star point. Install protectors either within an existing cabinet/ cubicle or in a separate enclosure.

Accessories

ESP SL30L/4-20/M
Module replacement

ESP SL/B
Base replacement

Full product range order codes can be found on pages 17/8-17/9

TECHNICAL NOTE: 4-20 mA current loops can serve multiple devices over a long distance. The devices and wiring produce a voltage drop (also known as "loop drops") but these do not reduce the 4-20 mA current as long as the power supply voltage is greater than the sum of the voltage drops around the loop at the maximum signalling current of 20 mA. For design considerations, each ESP SL30L/4-20 device installed within the loop introduces a 1.7 V loop drop.

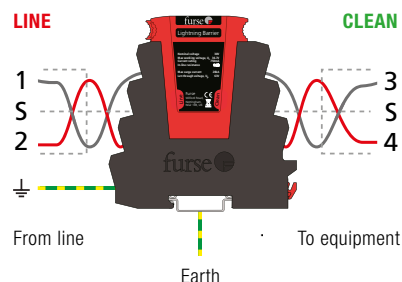

NOTE: The ESP SL 'Slim Line' Series is also available for protection of systems up to 110 V as well as 3-wire, RS 485, RTD & telecommunication applications (ESP SL/3W, ESP SL RS485, ESP SL RTD & ESP SL TN). The ESP SL X Series has approvals for use in hazardous areas.

Data & signal protection

ESP SL LED 4-20 mA Series

ESP NEW SL LED 4-20 mA Series - Technical specification

Electrical specification	ESP SL30L/4-20	
ABB order code	7TCA085400R0070	
Nominal voltage ⁽¹⁾	30 V	
Maximum working voltage U_c (RMS/DC) ⁽²⁾	25 V / 36.7 V	
Current rating (signal) ⁽³⁾	75 mA	
In-line resistance (per line $\pm 10\%$)	1.0 Ω	
Series voltage drop ⁽⁴⁾	1.7 V	
Transient specification	ESP SL30L/4-20	
Let-through voltage (all conductors)⁽⁵⁾ Up		
C2 test 4 kV 1.2/50 μ s, 2 kA 8/20 μ s to BS EN/EN/IEC 61643-21	63.0 V	
C1 test 1 kV, 1.2/50 μ s, 0.5 kA 8/20 μ s to BS EN/EN/IEC 61643-21	51.3 V	
B2 test 4 kV 10/700 μ s to BS EN/EN/IEC 61643-21	45.4 V	
5 kV, 10/700 μ s ⁽⁶⁾	46.3 V	
Maximum surge current		
D1 test 10/350 μ s to BS EN/EN/IEC 61643-21:	- Per signal wire	1.25 kA
8/20 μ s to ITU-T K.45:2003, IEEE C62.41.2:2002:	- Per pair	2.5 kA
	- Per signal wire	10 kA
	- Per pair	20 kA
Mechanical specification	ESP SL30L/4-20	
Temperature range	-40 to +80 °C	
Connection type	Screw terminal - maximum torque 0.8 Nm	
Conductor size (stranded)	4 mm ²	
Earth connection	Via DIN rail or 4 mm ² earth terminal - maximum torque 0.8 Nm	
Case material	FR Polymer UL-94 V-0	
Weight: - Unit	0.08 kg	
- Packaged (per 10)	0.85 kg	
Dimensions	See diagram below	

- ⁽¹⁾ Nominal voltage (RMS/DC or AC peak) measured at < 10 μ A
⁽²⁾ Maximum working voltage (RMS/DC or AC peak) measured at < 1 mA leakage
⁽³⁾ The minimum current for LED indicator operation is 2 mA
⁽⁴⁾ At 20 mA
⁽⁵⁾ The maximum transient voltage let-through of the protector throughout the test ($\pm 10\%$), line to line & line to earth, both polarities. Response time < 10 ns
⁽⁶⁾ Test to IEC 61000-4-5:2006, ITU-T (formerly CCITT) K.20, K.21 and K.45, Telcordia GR-1089-CORE, Issue 2:2002, ANSI TIA/EIA/IS-968-A:2002 (formerly FCC Part 68)

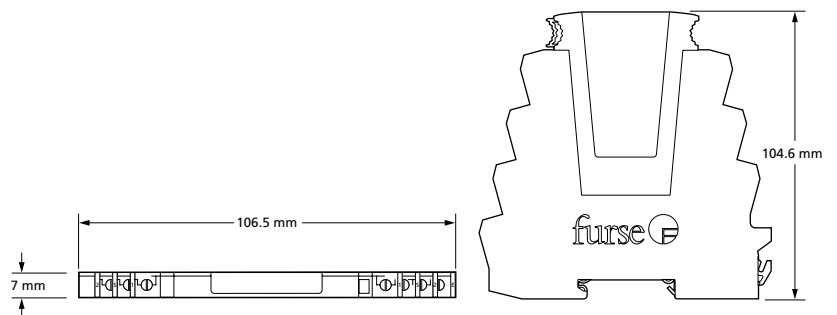

Data & signal protection

ESP SL 3-Wire Series



LPZ 0→3	FULL MODE Bonding + Equipment Protection	REPLACEABLE PROTECTION MODULE	SIGNAL/ TELECOM TEST CAT D + C + B	ENHANCED Low let-through voltage	LOW IN-LINE RESISTANCE 1 Ω
CURRENT RATING 500 mA	HIGH BANDWIDTH	ULTRA SLIM 7 mm WIDTH			

Combined Category D, C, B tested protector (to BS EN 61643) suitable for 3-wire signalling applications which require either a lower in-line resistance, an increased current and/or higher bandwidth. Also suitable for DC power applications less than 0.5 Amps. Available for working voltages of up to 6, 15, 30, 50 and 110 Volts. For use at boundaries up to LPZ 0 to protect against flashover (typically the service entrance location) through to LPZ 3 to protect sensitive electronic equipment.

Features & benefits

- Very low let-through voltage (enhanced protection to IEC/BS EN 62305) between all lines - Full Mode protection
- Full Mode design capable of handling partial lightning currents as well as allowing continual operation of protected equipment
- Repeated protection in lightning intense environments
- Ultra slim 7 mm width ideal for compact protection of large numbers of lines (e.g. process control installations)
- Two stage removable protection module with simple quick release mechanism allowing partial removal for easy line commissioning and maintenance as well as full removal for protection replacement
- Very low (1 Ω) in-line resistance allows resistance critical applications (e.g. alarm loops) to be protected
- High (500 mA) maximum running current
- High bandwidth enables higher frequency (high traffic or bit rate) data communications
- Strong, flame retardant, polycarbonate housing
- Built-in innovative DIN rail foot with locking feature for simple positioning and clip-on mounting to top hat DIN rails
- 4 mm² terminals allow for larger cross section wiring, stranded wires terminated with ferrules or fitting two wires into a single terminal
- Convenient earthing through DIN foot and/or earth terminal

Application

Use these protectors for 3-wire systems where installation space is at a premium and large numbers of lines require protection (e.g. process control, high speed digital communication equipment or systems with long signal lines).

Installation

Connect in series with the data communication or signal line either near where it enters or leaves the building or close to the equipment being protected (e.g. within its control panel). Either way, it must be very close to the system's earth star point. Install protectors either within an existing cabinet/ cubicle or in a separate enclosure.

Accessories

Replacement modules:
ESP SLXX/3W/M **ESP SL/3W/B**
 Standard module replacement where XX is Base replacement
 voltage rating (06, 15, 30, 50 or 110)

Full product range order codes can be found on pages 17/8-17/9

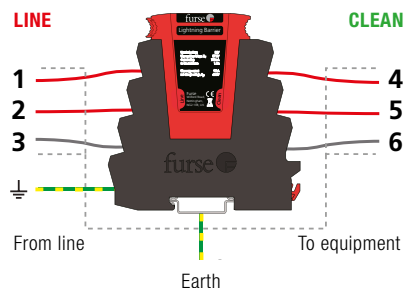

NOTE: The ESP SL 'Slim Line' Series is also available for protection of 2-wire systems up to 110 V, RS 485, RTD and telecommunication applications (ESP SL Series, ESP SL RS485, ESP SL RTD and ESP SL TN). The ESP SL X Series has approvals for use in hazardous areas.

Data & signal protection

ESP SL 3-Wire Series

ESP SL 3-Wire Series - Technical specification

Electrical specification	ESP SL06/3W	ESP SL15/3W	ESP SL30/3W	ESP SL50/3W	ESP SL110/3W
ABB order code	7TCA085400R0238	7TCA085400R0269	7TCA085400R0268	7TCA085400R0267	7TCA085400R0266
Nominal voltage ⁽¹⁾	6 V	15 V	30 V	50 V	110 V
Maximum working voltage U_c (RMS/DC) ⁽²⁾	5 V / 7.79 V	11 V / 16.7 V	25 V / 36.7 V	40 V / 56.7 V	93 V / 132 V
Current rating (signal)	500 mA				
In-line resistance (per line $\pm 10\%$)	1.0 Ω				
Series voltage drop	45 MHz				
Transient specification	ESP SL06/3W	ESP SL15/3W	ESP SL30/3W	ESP SL50/3W	ESP SL110/3W
Let-through voltage (all conductors)⁽³⁾ Up					
C2 test 4 kV 1.2/50 μ s, 2 kA 8/20 μ s to BS EN/EN/IEC 61643-21	36.0 V	38.4 V	63.0 V	90.3 V	185 V
C1 test 1 kV, 1.2/50 μ s, 0.5 kA 8/20 μ s to BS EN/EN/IEC 61643-21	26.2 V	29.4 V	51.3 V	77.2 V	175 V
B2 test 4 kV 10/700 μ s to BS EN/EN/IEC 61643-21	16.0 V	26.8 V	45.4 V	68.3 V	165 V
5 kV, 10/700 μ s ⁽⁴⁾	17.0 V	27.5 V	46.3 V	69.1 V	170 V
Maximum surge current					
D1 test 10/350 μ s to BS EN/EN/IEC 61643-21: – Per signal wire	1.25 kA				
8/20 μ s to ITU-T K.45:2003, – Per pair	2.5 kA				
IEEE C62.41.2:2002: – Per signal wire	10 kA				
– Per pair	20 kA				
Mechanical specification	ESP SL06/3W	ESP SL15/3W	ESP SL30/3W	ESP SL50/3W	ESP SL110/3W
Temperature range	-40 to +80 °C				
Connection type	Screw terminal - maximum torque 0.8 Nm				
Conductor size (stranded)	4 mm ²				
Earth connection	Via DIN rail or 4 mm ² earth terminal - maximum torque 0.8 Nm				
Case material	FR Polymer UL-94 V-0				
Weight: – Unit	0.08 kg				
– Packaged (per 10)	0.85 kg				
Dimensions	See diagram below				

⁽¹⁾ Nominal voltage (RMS/DC or AC peak) measured at < 10 μ A (ESP SL15/3W, ESP SL30/3W, ESP SL50/3W, ESP SL110/3W) and < 200 μ A (ESP SL06/3W)

⁽²⁾ Maximum working voltage (RMS/DC or AC peak) measured at < 1 mA leakage

⁽³⁾ The maximum transient voltage let-through of the protector throughout the test ($\pm 10\%$), line to line & line to earth, both polarities. Response time < 10 ns

⁽⁴⁾ Test to IEC 61000-4-5:2006, ITU-T (formerly CCITT) K.20, K.21 and K.45, Telcordia GR-1089-CORE, Issue 2:2002, ANSI TIA/EIA/IS-968-A:2002 (formerly FCC Part 68)

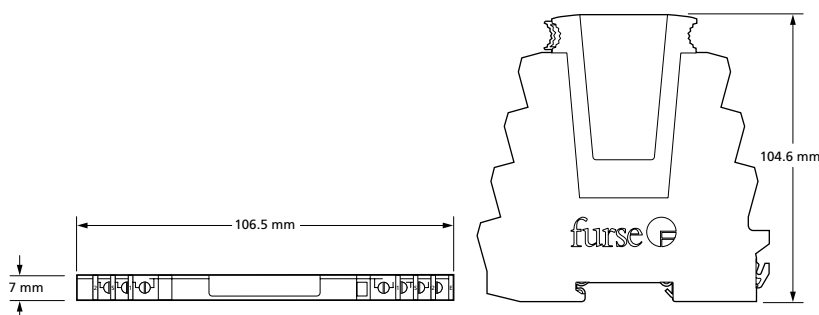

Data & signal protection

ESP Q & TNQ Series

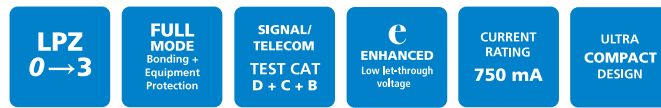

Combined Category D, C, B tested protector (to BS EN 61643) suitable for 4 twisted pair lines. Available for working voltages of up to 6, 15, 30, 50 and 110 Volts. ESP TNQ suitable for Broadband, POTS, dial-up, T1/E1, lease line and *DSL telephone applications. For use at boundaries up to LPZ 0 to protect against flashover (typically the service entrance location) through to LPZ 3 to protect sensitive

Features & benefits

- Very low let-through voltage (enhanced protection to IEC/BS EN 62305) between all lines - Full Mode protection
- Full Mode design capable of handling partial lightning currents as well as allowing continual operation of protected equipment
- Repeated protection in lightning intense environments
- Almost twice as space efficient as smallest competitor
- Standard DIN module (18 mm) depth
- Removable (plug-in) terminals allow pre-wiring of cable looms, for easier installation
- Suitable for earthed or isolated screen systems
- Built-in DIN rail foot for clip-on mounting to top hat or G DIN rails
- Optional flat mounting on side
- 2.5 mm² terminals allow for larger cross section wiring, stranded wires terminated with ferrules or fitting two wires into a single terminal
- Very low resistance to minimizes unwanted signal strength reductions
- Strong, flame retardant, ABS housing
- Colour coded terminals (grey for line, green for clean) give a quick and easy installation check
- Screen terminal enables easy connection of cable screen to earth
- Simple, yet substantial, connection to earth via DIN rail
- ESP TNQ is suitable for telecommunication applications in accordance with Telcordia and ANSI Standards (see Application Note AN005)
- Available as a 'UL Listed' version, add /UL to part code (ESP 06Q, ESP 15Q, ESP 30Q and ESP 50Q only)

Application

Use these protectors where installation space is at a premium and large numbers of lines require protection.

Installation

Connect in series with the signal or data line either near where it enters or leaves the building or close to the equipment being protected. Install in a cabinet/cubicle close to the system's earth star point.

Accessories

For suitable enclosures for the ESP Q & TNQ Series, please contact us.

Full product range order codes can be found on pages 17/8-17/9

ESP 06Q, ESP 15Q, ESP 30Q, ESP 50Q, ESP 110Q and ESP TNQ installed in series (in-line)

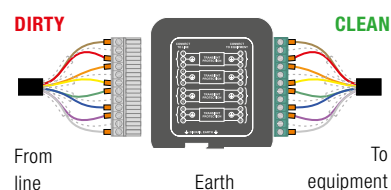

NOTE: The ESP Q Series is also available for protection of RS 485 and RTD applications (ESP RS485Q, ESP RTDQ). Protectors for individual data and signal lines are available (ESP D Series and Slim Line ESP SL Series), or ready-boxed to IP66 (ESP **D/BX etc). Alternatively, for individual protectors with higher current or bandwidth use the ESP E and ESP H Series.

Data & signal protection

ESP Q & TNQ Series

ESP Q & TNQ Series - Technical specification

Electrical specification	ESP 06Q	ESP 15Q	ESP 30Q	ESP 50Q	ESP 110Q	ESP TNQ
ABB order code	7TCA085400R0087	7TCA085400R0098	7TCA085400R0107	7TCA085400R0118	7TCA085400R0088	7TCA085400R0183
Nominal voltage ⁽¹⁾	6 V	15 V	30 V	50 V	110 V	–
Maximum working voltage U_c (RMS/DC) ⁽²⁾	5 V / 7.79 V	13 V / 18.8 V	26 V / 37.8 V	41 V / 57.8 V	93 V / 132 V	– / 296 V
Current rating (signal)	750 mA	750 mA	750 mA	750 mA	750 mA	300 mA
In-line resistance (per line $\pm 10\%$)	1.0 Ω	1.0 Ω	1.0 Ω	1.0 Ω	1.0 Ω	4.3 Ω
Bandwidth (-3 dB 50 Ω system)	1 MHz	2.5 MHz	6 MHz	5 MHz	15 MHz	20 MHz
Transient specification	ESP 06Q	ESP 15Q	ESP 30Q	ESP 50Q	ESP 110Q	ESP TNQ
Let-through voltage (all conductors)⁽³⁾ Up						
C2 test 4 kV 1.2/50 μ s, 2 kA 8/20 μ s to BS EN/EN/IEC 61643-21	15.0 V	28.0 V	53.0 V	84.0 V	188 V	395 V
C1 test 1 kV, 1.2/50 μ s, 0.5 kA 8/20 μ s to BS EN/EN/IEC 61643-21	12.5 V	26.5 V	48.0 V	76.0 V	175 V	390 V
B2 test 4 kV 10/700 μ s to BS EN/EN/IEC 61643-21	10.0 V	23.0 V	43.5 V	64.5 V	145 V	298 V
5 kV, 10/700 μ s ⁽⁴⁾	10.8 V	26.2 V	44.3 V	65.8 V	150 V	300 V
Maximum surge current						
D1 test 10/350 μ s to BS EN/EN/IEC 61643-21: – Per signal wire	2.5 kA					
8/20 μ s to ITU-T K.45:2003, – Per pair	5 kA					
IEEE C62.41.2:2002: – Per signal wire	10 kA					
– Per pair	20 kA					
Mechanical specification	ESP 06Q	ESP 15Q	ESP 30Q	ESP 50Q	ESP 110Q	ESP TNQ
Temperature range	-40 to +80 °C					
Connection type	Pluggable 12 way screw terminal - maximum torque 0.6 Nm					
Conductor size (stranded)	2.5 mm ²					
Earth connection	Via DIN rail or M5 threaded hole in base of unit					
Case material	FR Polymer UL-94 V-0					
Weight: – Unit	0.1 kg					
– Packaged (each)	0.12 kg					
– Packaged (per 10)	1.3 kg					
Dimensions	See diagram below					

⁽¹⁾ Nominal voltage (RMS/DC or AC peak) measured at < 5 μ A (ESP 15Q, ESP 30Q, ESP 50Q, ESP 110Q) and < 200 μ A (ESP 06Q)

⁽²⁾ Maximum working voltage (RMS/DC or AC peak) measured at < 5 mA leakage (ESP 15Q, ESP 30Q, ESP 50Q, ESP 110Q) and < 10 μ A (ESP TNQ)

⁽³⁾ The maximum transient voltage let-through of the protector throughout the test ($\pm 10\%$), line to line & line to earth, both polarities. Response time < 10 ns

⁽⁴⁾ Test to IEC 61000-4-5:2006, ITU-T (formerly CCITT) K.20, K.21 and K.45, Telcordia GR-1089-CORE, Issue 2:2002, ANSI TIA/EIA/IS-968-A:2002 (formerly FCC Part 68)

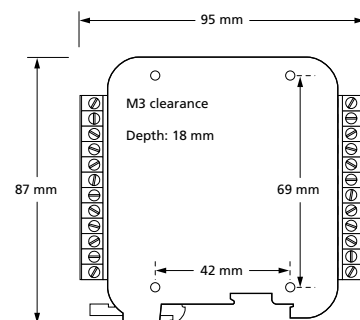

Data & signal protection

ESP KS & KE Series

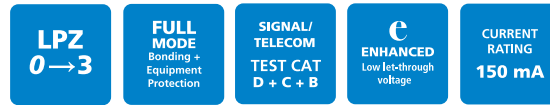
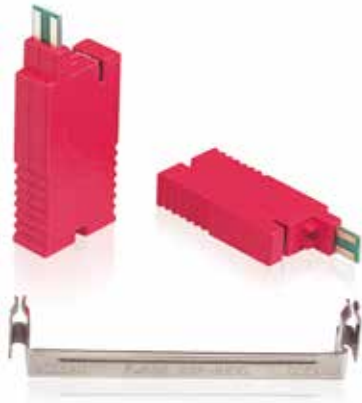

Combined Category D, C, B tested protector (to BS EN 61643) suitable for use on ten line LSA-PLUS disconnection modules to protect individual twisted pair data or signal lines. For use at boundaries up to LPZ 0 to protect against flashover (typically the service entrance location) through to LPZ 3 to protect sensitive electronic equipment.

Features & benefits

- Low cost protection for large numbers of data and signal lines
- Very low let-through voltage (enhanced protection to IEC/BS EN 62305) between all lines - Full Mode protection
- Full Mode design capable of handling partial lightning currents as well as allowing continual operation of protected equipment
- Repeated protection in lightning intense environments
- Quick and easy plug-in installation
- Colour of housing distinguishes electrically different protectors to help avoid confusion when installed with other protectors (e.g. the ESP KT1/2) on the same distribution frame
- Protect only the lines you need
- Ridged finger holds make it easy to obtain a firm grip for installation or removal
- Use the ESP KE10 to provide trouble free earthing for up to ten protectors (per disconnection module)

Application

Use these units to protect signal, data, control and instrumentation systems with LSA-PLUS disconnection modules.

Full product range order codes can be found on pages 17/8-17/9

Installation

Install protectors on all data communication and signal lines that enter or leave each building. All protectors must be installed via the ESP KE10 earth bar. Identify the lines requiring protection and clip the ESP KE10 on to the disconnection modules' earth points. Plug the protector directly into each disconnection module requiring protection (ensuring the correct orientation) for a series connection.

In the unlikely situation that the protector is damaged, it will sacrifice itself and fail short circuit, taking the line out of commission. In addition to indicating that the protector needs replacing, this will also prevent subsequent transients from damaging the equipment.

NOTE: For PSTN and U interface ISDN lines on LSA-PLUS modules, use the ESP KT1 or ESP K10T1. For S/T interface ISDN lines on LSA-PLUS modules, use the ESP KT2 or ESP K10T2. For individual twisted pair data or signal lines, use the ESP D, E or H Series Lightning Barriers. The ESP SL and ESP Q Series Lightning Barriers are suitable for high density data and signal lines.

Data & signal protection

ESP KS & KE Series

ESP KS & KE Series - Technical specification

Electrical specification	ESP KS06	ESP KS15	ESP KS30	ESP KS50	
ABB order code	7TCA085400R0029	7TCA085400R0030	7TCA085400R0032	7TCA085400R0033	
Nominal voltage ⁽¹⁾	6 V	15 V	30 V	50 V	
Maximum working voltage U_c (RMS/DC) ⁽²⁾	5 V / 7.79 V	11 V / 16.7 V	24 V / 33.4 V	41 V / 58 V	
Current rating (signal)	150 mA				
In-line resistance (per line $\pm 10\%$)	1 Ω	22 Ω	22 Ω	22 Ω	
Bandwidth (-3 dB 50 Ω system)	2 MHz	5 MHz	5 MHz	5 MHz	
Transient specification	ESP KS06	ESP KS15	ESP KS30	ESP KS50	
Let-through voltage (all conductors)⁽³⁾ Up					
C2 test 4 kV 1.2/50 μ s, 2 kA 8/20 μ s to BS EN/EN/IEC 61643-21	16.0 V	26.5 V	48.0 V	98.0 V	
C1 test 1 kV, 1.2/50 μ s, 0.5 kA 8/20 μ s to BS EN/EN/IEC 61643-21	14.5 V	24.0 V	46.5 V	84.5 V	
B2 test 4 kV 10/700 μ s to BS EN/EN/IEC 61643-21	11.5 V	23.0 V	45.0 V	75.0 V	
5 kV, 10/700 μ s ⁽⁴⁾	12.0 V	24.4 V	48.8 V	80.0 V	
Maximum surge current⁽⁵⁾					
D1 test 10/350 μ s to BS EN/EN/IEC 61643-21:	- Per signal wire	1 kA			
	- Per pair	2 kA			
8/20 μ s to ITU-T K.45:2003, IEEE C62.41.2:2002:	- Per signal wire	5 kA			
	- Per pair	10 kA			
Mechanical specification	ESP KS06	ESP KS1	ESP KS30	ESP KS50	ESP KE10
Temperature range	-40 to +80 °C				-
Connection type	To LSA-PLUS disconnection modules (BT part number 237A)				
Earth connection	Via ESP KE10 earth bar				-
Material	FR Polymer UL-94 V-0				Stainless Steel
Weight: - Unit	0.01 kg				0.01 kg
- Packaged	0.10 kg (per 10)				0.12 kg (per 10)
Dimensions	See diagram below				

⁽¹⁾ Nominal voltage (RMS/DC or AC peak) at 200 μ A for ESP KS06 and at 5 μ A for ESP KS15, ESP KS30 and ESP KS50

⁽²⁾ Maximum working voltage (RMS/DC or AC peak) at 10 mA for ESP KS06, at 1 mA for ESP KS15 and ESP KS30, and at 5 μ A for ESP KS50.

⁽³⁾ The maximum transient voltage let-through of the protector throughout the test ($\pm 10\%$), line to line & line to earth, both polarities. Response time < 10 ns

⁽⁴⁾ Test to IEC 61000-4-5:2006, ITU-T (formerly CCITT) K.20, K.21 and K.45, Telcordia GR-1089-CORE, Issue 2:2002, ANSI TIA/EIA/IS-968-A:2002 (formerly FCC Part 68)

⁽⁵⁾ The installation and connections external to the protector may limit the capability of the protector

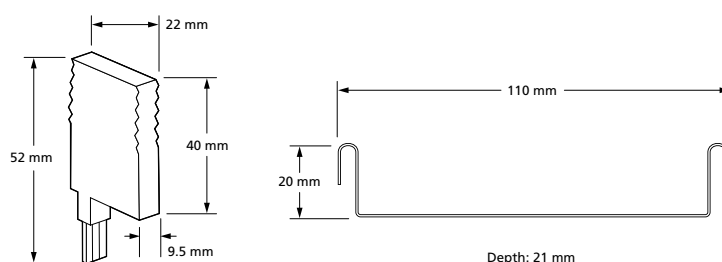

Data & signal protection

ESP PCB/D & PCB/TN Series

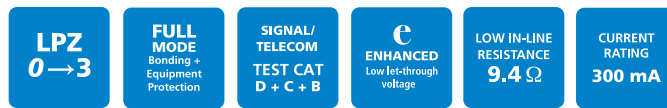

Combined Category D, C, B tested protector (to BS EN 61643) for ‘through hole’ mounting directly onto the PCB of data communication, signal or telephone equipment. Available for working voltages of up to 110 Volts. ESP PCB/TN suitable for Broadband, POTS, dial-up, T1/E1, lease line and *DSL telephone applications. For use at boundaries up to LPZ 0 to protect against flashover (typically the service entrance location) through to LPZ 3 to protect sensitive electronic equipment.

Features & benefits

- Suitable for wave soldering
- Very low let-through voltage (enhanced protection to IEC/BS EN 62305) between all lines - Full Mode protection
- Full Mode design capable of handling partial lightning currents as well as allowing continual operation of protected equipment
- Repeated protection in lightning intense environments
- Low in-line resistance minimizes unnecessary reductions in signal strength
- 2 pin clean end and 3 pin line end to ensure correct insertion
- ESP PCB/TN is suitable for telecommunication applications in accordance with Telcordia and ANSI Standards (see Application Note AN005)

Installation

Connect in series, soldering pins direct onto PCB. Tracks to line and earth pins should be as wide as practical (see Furse Application Note AN003). Dirty (line) tracks should be routed parallel and as close together as possible. This should also be implemented on clean tracks, however clean tracks should never be routed close and parallel to line tracks or dirty barrier earth connections as transients can be re-introduced after the protector due to electromagnetic coupling.

The use of an earth layer or plane is highly recommended as this reduces the electromagnetic field produced by a transient discharging to earth considerably, and hence the chance of the transient being picked up on clean tracks.

Full product range order codes can be found on pages 17/8-17/9

Maximum line to clean separation. Large input tracks and pads (using top and bottom copper layers). Earth pin is bonded to an earth layer/plane.

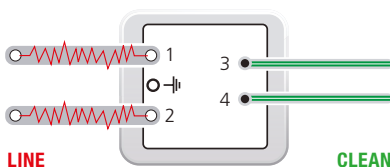

All dirty (line) incoming tracks are separated from the clean output tracks, individual line and clean tracks are routed close together. Earth pins are bonded to an earth layer/plane.

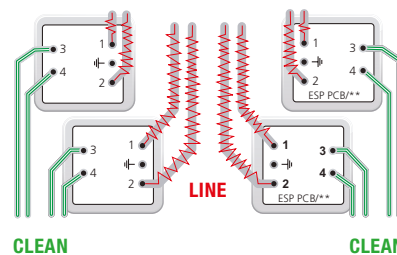

Data & signal protection

ESP PCB/D & PCB/TN Series

ESP PCB/D & PCB/TN Series - Technical specification

Electrical specification	ESP PCB/06D	ESP PCB/15D	ESP PCB/30D	ESP PCB/50D	ESP PCB/110D	ESP PCB/TN
ABB order code	7TCA085400R0038	7TCA085400R0042	7TCA085400R0154	7TCA085400R0155	7TCA085400R0040	7TCA085400R0157
Nominal voltage ⁽¹⁾	6 V	15 V	30 V	50 V	110 V	–
Maximum working voltage U_c (RMS/DC) ⁽²⁾	5 V / 7.79 V	13 V / 19 V	26 V / 37.1 V	41 V / 58 V	93 V / 132 V	– / 296 V
Current rating (signal)	300 mA					
In-line resistance (per line $\pm 10\%$)	9.4 Ω	9.4 Ω	9.4 Ω	9.4 Ω	9.4 Ω	4.4 Ω
Bandwidth (-3 dB 50 Ω system)	800 kHz	2.5 MHz	4 MHz	6 MHz	9 MHz	20 MHz
Transient specification	ESP PCB/06D	ESP PCB/15D	ESP PCB/30D	ESP PCB/50D	ESP PCB/110D	ESP PCB/TN
Let-through voltage (all conductors)⁽³⁾ Up						
C2 test 4 kV 1.2/50 μ s, 2 kA 8/20 μ s to BS EN/EN/IEC 61643-21	12.0 V	25.0 V	44.0 V	78.0 V	155 V	395 V
C1 test 1 kV, 1.2/50 μ s, 0.5 kA 8/20 μ s to BS EN/EN/IEC 61643-21	11.5 V	24.5 V	43.5 V	76.0 V	150 V	390 V
B2 test 4 kV 10/700 μ s to BS EN/EN/IEC 61643-21	10.0 V	23.0 V	42.5 V	73.0 V	145 V	298 V
5 kV, 10/700 μ s ⁽⁴⁾	10.5 V	23.8 V	43.4 V	74.9 V	150 V	300 V
Maximum surge current⁽⁵⁾						
D1 test 10/350 μ s to BS EN/EN/IEC 61643-21: – Per signal wire	2.5 kA					
8/20 μ s to ITU-T K.45:2003, – Per signal wire	5 kA					
IEEE C62.41.2:2002: – Per signal wire	10 kA					
– Per pair	20 kA					
Mechanical specification	ESP PCB/D & PCB/TN Series					
Temperature range	-40 to +80 °C					
Connection type	0.64 mm (0.025") square PCB pins, 1.2 mm diameter PCB holes recommended					
Case Material	FR Polymer UL-94 V-0					
Dimensions	See diagram below					

⁽¹⁾ Nominal voltage (RMS/DC or AC peak) measured at < 5 μ A (ESP PCB/15D, ESP PCB/30D, ESP PCB/50D, ESP PCB/110D) and < 200 μ A (ESP PCB/06D)

⁽²⁾ Maximum working voltage (RMS/DC or AC peak) measured at < 1 mA leakage (ESP PCB/15D, ESP PCB/30D, ESP PCB/50D, ESP PCB/110D), < 10 mA (ESP PCB/06D) and < 10 μ A (ESP PCB/TN)

⁽³⁾ The maximum transient voltage let-through of the protector throughout the test ($\pm 10\%$), line to line & line to earth, both polarities. Response time < 10 ns

⁽⁴⁾ Test to IEC 61000-4-5:2006, ITU-T (formerly CCITT) K.20, K.21 and K.45, Telcordia GR-1089-CORE, Issue 2:2002, ANSI TIA/EIA/IS-968-A:2002 (formerly FCC Part 68)

⁽⁵⁾ The installation and connections external to the protector may limit the capability of the protector

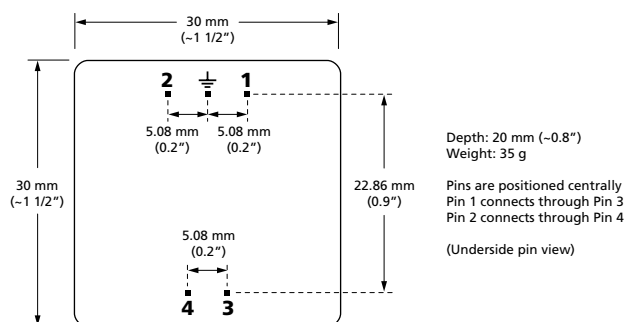

Data & signal protection

ESP PCB/E Series

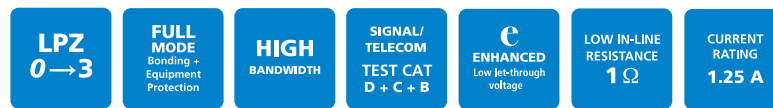
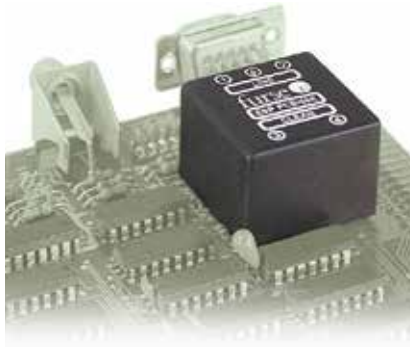

Combined Category D, C, B tested protector (to BS EN 61643) for ‘through hole’ mounting directly onto the PCB of data communication, signal or telephone equipment which require a lower in-line resistance, an increased current or a higher bandwidth than the PCB/**D Series. Available for working voltages of up to 110 Volts for AC & DC power applications up to 125 Amps. For use at boundaries up to LPZ 0 to protect against flashover (typically the service entrance location) through to LPZ 3 to protect sensitive electronic equipment.

Features & benefits

- Suitable for wave soldering
- Very low let-through voltage (enhanced protection to IEC/BS EN 62305) between all lines - Full Mode protection
- Full Mode design capable of handling partial lightning currents as well as allowing continual operation of protected equipment
- Repeated protection in lightning intense environments
- Very low (1 Ω) in-line resistance for resistance critical applications
- High (1.25 A) maximum running current
- Higher bandwidth enables higher frequency data communications
- 2 pin clean end and 3 pin line end to ensure correct insertion

Installation

Connect in series, soldering pins direct onto PCB. Tracks to line and earth pins should be as wide as practical (see Furse Application Note AN003). Dirty (line) tracks should be routed parallel and as close together as possible. This should also be implemented on clean tracks, however clean tracks should never be routed close and parallel to line tracks or dirty barrier earth connections as earth connections as transients can be re-introduced after the protector due to electromagnetic coupling.

The use of an earth layer or plane is highly recommended as this reduces the electromagnetic field produced by a transient discharging to earth considerably, and hence the chance of the transient being picked up on clean tracks.

Full product range order codes can be found on pages 17/8-17/9

Maximum line to clean separation. Large input tracks and pads (using top and bottom copper layers). Earth pin is bonded to an earth layer/plane.

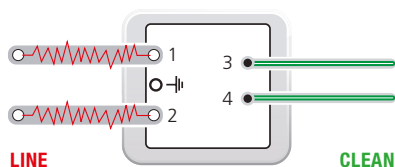

All dirty (line) incoming tracks are separated from the clean output tracks, individual line and clean tracks are routed close together. Earth pins are bonded to an earth layer/plane.

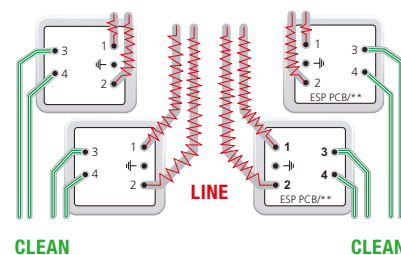

Data & signal protection

ESP PCB/E Series

ESP PCB/E Series - Technical specification

Electrical specification	ESP PCB/06E	ESP PCB/15E	ESP PCB/30E	ESP PCB/50E	ESP PCB/110E
ABB order code	7TCA085400R0039	7TCA085400R0153	7TCA085400R0043	7TCA085400R0156	7TCA085400R0041
Nominal voltage ⁽¹⁾	6 V	15 V	30 V	50 V	110 V
Maximum working voltage U_c (RMS/DC) ⁽²⁾	5 V / 7.79 V	11 V / 16.7 V	25 V / 36.7 V	40 V / 56.7 V	93 V / 132 V
Current rating (signal)	1.25 A				
In-line resistance (per line $\pm 10\%$)	1.0 Ω				
Bandwidth (-3 dB 50 Ω system)	45 MHz				
Transient specification	ESP PCB/06E	ESP PCB/15E	ESP PCB/30E	ESP PCB/50E	ESP PCB/110E
Let-through voltage (all conductors)⁽³⁾ Up					
C2 test 4 kV 1.2/50 μ s, 2 kA 8/20 μ s to BS EN/EN/IEC 61643-21	36.0 V	39.0 V	60.0 V	86.0 V	180 V
C1 test 1 kV, 1.2/50 μ s, 0.5 kA 8/20 μ s to BS EN/EN/IEC 61643-21	26.2 V	28.0 V	49.0 V	73.5 V	170 V
B2 test 4 kV 10/700 μ s to BS EN/EN/IEC 61643-21	16.0 V	25.5 V	43.5 V	65.0 V	160 V
5 kV, 10/700 μ s ⁽⁴⁾	17.0 V	26.2 V	44.3 V	65.8 V	165 V
Maximum surge current⁽⁵⁾					
D1 test 10/350 μ s to BS EN/EN/IEC 61643-21: - Per signal wire	2.5 kA				
8/20 μ s to ITU-T K.45:2003, IEEE C62.41.2:2002: - Per pair	5 kA				
	10 kA				
	20 kA				
Mechanical specification	ESP PCB/E Series				
Temperature range	-40 to +80 °C				
Connection type	0.64 mm (0.025") square PCB pins, 1.2 mm diameter PCB holes recommended				
Case Material	FR Polymer UL-94 V-0				
Dimensions	See diagram below				

⁽¹⁾ Nominal voltage (RMS/DC or AC peak) measured at < 10 μ A (ESP PCB/15E, ESP PCB/30E, ESP PCB/50E, ESP PCB/110E) and < 200 μ A (ESP PCB/06E)

⁽²⁾ Maximum working voltage (RMS/DC or AC peak) measured at < 5 mA leakage (ESP PCB/15E, ESP PCB/30E, ESP PCB/50E, ESP PCB/110E), < 10 mA (ESP PCB/06E)

⁽³⁾ The maximum transient voltage let-through of the protector throughout the test ($\pm 10\%$), line to line & line to earth, both polarities. Response time < 10 ns

⁽⁴⁾ Test to IEC 61000-4-5:2006, ITU-T (formerly CCITT) K.20, K.21 and K.45, Telcordia GR-1089-CORE, Issue 2:2002, ANSI TIA/EIA/IS-968-A:2002 (formerly FCC Part 68).

⁽⁵⁾ The installation and connections external to the protector may limit the capability of the protector

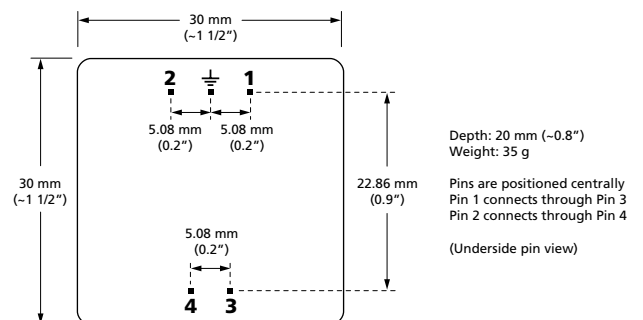

Data & signal protection

ESP RTD, RTDQ & SL RTD Series

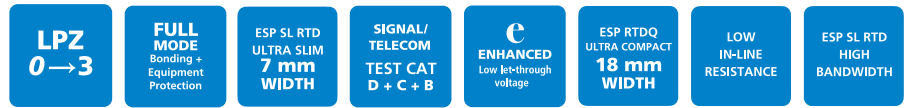

Combined Category D, C, B tested protector (to BS EN 61643) suitable for 3-wire RTD systems to protect monitoring equipment. For use at boundaries up to LPZ 0 (ESP RTD & ESP RTDQ) or LPZ 0 (ESP SL RTD) to protect against flashover (typically the service entrance location) through to LPZ 3. Available as standard ESP RTD format, or compact ESP RTDQ and Slim Line ESP SL RTD versions for installations where a high number of lines require protection.

Features & benefits

- Protects all three wires on a 3-wire RTD system with a single protector
- Very low let-through voltage (enhanced protection to IEC/BS EN 62305) between all lines - Full Mode protection
- Full Mode design capable of handling partial lightning currents as well as allowing continual operation of protected equipment
- Repeated protection in lightning intense environments
- Low in-line resistance minimizes reductions in signal strength
- Built-in DIN rail foot for simple mounting to top hat DIN rails
- Convenient earthing through DIN foot and/or earth terminal
- ESP RTD can be flat mounted on base or side
- ESP RTD and ESP RTDQ have colour coded terminals for quick and easy installation check
- ESP SL RTD has ultra slim 7 mm width ideal for compact protection of large numbers of lines (e.g. process control installations)
- ESP SL RTD includes two stage removable protection module with simple quick release mechanism allowing partial removal for easy line commissioning and maintenance as well as full removal for protection replacement

For further information on RTD applications, see separate Application Note AN001 (contact us for a copy).

Installation

Connect in series with the signal line either near where it enters or leaves the building or close to the equipment being protected ensuring it is very close to the system's earth star

point. Install protectors either within an existing cabinet/cubicle or in a separate enclosure.

12

Accessories

Replacement module for ESP SL RTD:

ESP SLRTD/M

Standard module replacement

ESP SLRTD/B

Base replacement

Combined Mounting/Earthing kits for ESP RTD:

CME 4 For up to 4 x ESP RTD

CME 8 For up to 8 x ESP RTD

CME 16 For up to 16 x ESP RTD

CME 32 For up to 32 x ESP RTD

Full product range order codes can be found on pages 17/8-17/9

ESP RTD installed in series

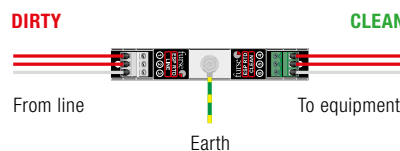

ESP RTDQ installed in series (in-line)

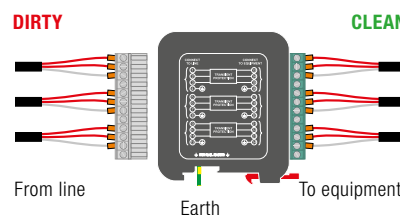

ESP SL RTD installed in series

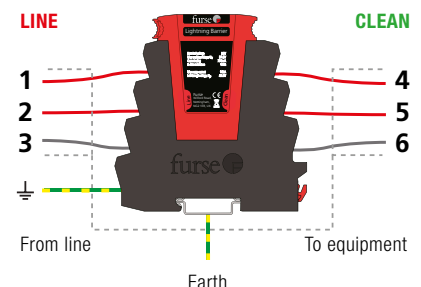

NOTE: For 2-wire or 4-wire RTD applications, use one or two ESP 06D or ESP SL06 protectors respectively.

Data & signal protection

ESP RTD, RTDQ & SL RTD Series

ESP RTD, RTDQ & SL RTD Series - Technical specification

Electrical specification	ESP RTD	ESP SL RTD	ESP RTDQ	
ABB order code	7TCA085460R0157	7TCA085400R0232	7TCA085400R0158	
Nominal voltage ⁽¹⁾	6 V			
Maximum working voltage U_c (RMS/DC) ⁽²⁾	5 V / 7.79 V			
Current rating (signal)	200 mA	500 mA	700 mA	
In-line resistance (per line $\pm 10\%$)	10 Ω	1.0 Ω	1.0 Ω	
Bandwidth (-3 dB 50 Ω system)	800 kHz	1.5 MHz	800 kHz	
Transient specification	ESP RTD	ESP SL RTD	ESP RTDQ	
Let-through voltage (all conductors)⁽³⁾ Up				
C2 test 4 kV 1.2/50 μ s, 2 kA 8/20 μ s to BS EN/EN/IEC 61643-21	12.0 V	17.9 V	15.0 V	
C1 test 1 kV, 1.2/50 μ s, 0.5 kA 8/20 μ s to BS EN/EN/IEC 61643-21	11.5 V	12.1 V	12.5 V	
B2 test 4 kV 10/700 μ s to BS EN/EN/IEC 61643-21	10.0 V	11.0 V	10.0 V	
5 kV, 10/700 μ s ⁽⁴⁾	10.5 V	11.3 V	10.5 V	
Maximum surge current				
D1 test 10/350 μ s to BS EN/EN/IEC 61643-21:	- Per signal wire	2.5 kA	1.25 kA	2.5 kA
8/20 μ s to ITU-T K.45:2003, IEEE C62.41.2:2002:	- Per pair	5 kA	2.5 kA	5 kA
	- Per signal wire	10 kA		
	- Per pair	20 kA		
Mechanical specification	ESP RTD	ESP SL RTD	ESP RTDQ	
Temperature range	-40 to +80 °C			
Connection type	Screw terminal - max. torque 0.5 Nm	Screw terminal - max. torque 0.8 Nm	Pluggable 12 way screw terminal	
Conductor size (stranded)	2.5 mm ²	4 mm ²	2.5 mm ²	
Earth connection	M6 stud - max. torque 0.5 Nm	Via DIN rail or 4 mm ² earth terminal - max. torque 0.8 Nm	Via DIN rail or M5 threaded hole in base of unit - max. torque 0.6 Nm	
Case Material	FR Polymer UL-94 V-0			
Weight: - Unit	0.08 kg	0.08 kg	0.1 kg	
- Packaged (per 10)	0.85 kg	0.85 kg	1.3 kg	
Dimensions	See diagram below			

⁽¹⁾ Nominal voltage (RMS/DC or AC peak) measured at < 200 μ A

⁽²⁾ Maximum working voltage (RMS/DC or AC peak) measured at < 10 mA

⁽³⁾ The maximum transient voltage let-through of the protector throughout the test ($\pm 10\%$), line to line & line to earth, both polarities. Response time < 10 ns

⁽⁴⁾ Test to IEC 61000-4-5:2006, ITU-T (formerly CCITT) K.20, K.21 and K.45, Telcordia GR-1089-CORE, Issue 2:2002, ANSI TIA/EIA/IS-968-A:2002 (formerly FCC Part 68)

ESP RTD

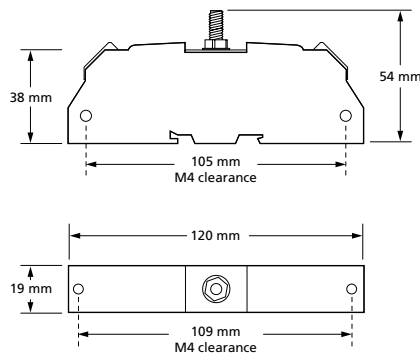

ESP RTDQ

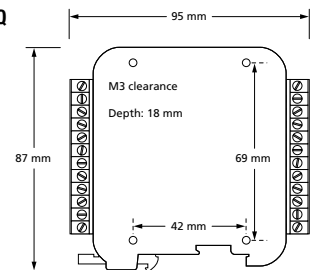

ESP SL RTD

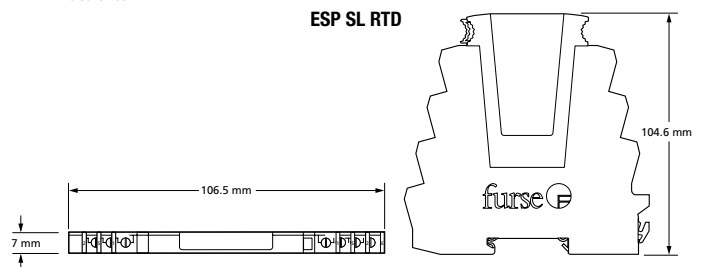

Data & signal protection

ESP RS485, RS485Q & SL RS485 Series



Combined Category D, C, B tested protector (to BS EN 61643) specifically designed for RS 485 and Fieldbus applications, such as Profibus DP. For use at boundaries up to LPZ 0 (ESP RS485 & ESP RS485Q), or LPZ 0 (ESP SL RS485) protect against flashover (typically the service entrance location) through to LPZ 3. Available as standard ESP RS485 format, or compact ESP RS485Q and Slim Line ESP SL RS485 versions for installations where a high number of lines require protection.

Features & benefits

- Very low let-through voltage (enhanced protection to IEC/BS EN 62305) between all lines - Full Mode protection
- Full Mode design capable of handling partial lightning currents as well as allowing continual operation of protected equipment
- Repeated protection in lightning intense environments
- 45 MHz bandwidth greatly exceeds 12 Mbps maximum speeds
- Low in-line resistance minimizes reductions in signal strength
- Suitable for earthed or isolated screen systems
- Built-in DIN rail foot for simple mounting to top hat DIN rails
- Convenient earthing through DIN foot and/or earth terminal
- ESP RS485 can be flat mounted on base or side
- ESP RS485 and ESP RS485Q have colour coded terminals for quick and easy installation check
- ESP SL RS485 has ultra slim 7 mm width ideal for compact protection of large numbers of lines (e.g. process control installations)
- ESP SL RS485 includes two stage removable protection module with simple quick release mechanism allowing partial removal for easy line commissioning and maintenance as well as full removal for protection replacement
- ESP SL RS485 includes optional LED status indication
- Add L suffix to part number - i.e. ESP SL RS485L

Application

Connect in series with the signal line either near where it enters or leaves the building or close to the equipment being protected ensuring it is very close to the system's earth star point. Install protectors either within an existing cabinet/cubicle or in a separate enclosure.

Accessories

Replacement module for ESP SL RS485: ESP SLRS485/M	Combined Mounting/Earthing kits for ESP RS485:
Standard module replacement ESP SLRS485/B	CME 4 For up to 4 x ESP RS485
Base replacement	CME 8 For up to 8 x ESP RS485
	CME 16 For up to 16 x ESP RS485
	CME 32 For up to 32 x ESP RS485

Full product range order codes can be found on pages 17/8-17/9

ESP RS485 installed in series

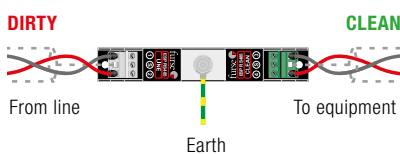

ESP SL RS485 installed in series

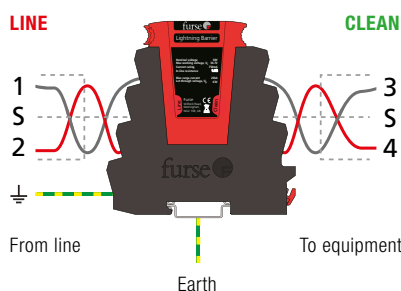

ESP RS485Q installed in series (in-line)

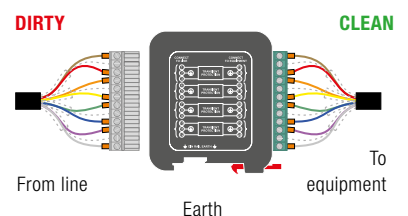

NOTE: The ESP SL 'Slim Line' Series is also available for protection of 3-wire and RTD applications (ESP SL/3W & ESP SL RTD). The ESP SL X Series has approvals for use in hazardous areas.

Data & signal protection

ESP RS485, RS485Q & SL RS485 Series

ESP RS485, RS485Q & SL RS485 Series - Technical specification

Electrical specification	ESP RS485	ESP SL RS485	ESP RS485Q	
ABB order code	7TCA085400R0191	7TCA085400R0193	7TCA085400R0192	
Nominal voltage ⁽¹⁾	15 V			
Maximum working voltage U_c (RMS/DC) ⁽²⁾	11 V / 16.7 V			
Current rating (signal)	300 mA			
In-line resistance (per line $\pm 10\%$)	1 Ω			
Bandwidth (-3 dB 50 Ω system)	45 MHz			
Transient specification	ESP RS485	ESP SL RS485	ESP RS485Q	
Let-through voltage (all conductors)⁽³⁾ Up				
C2 test 4 kV 1.2/50 μ s, 2 kA 8/20 μ s to BS EN/EN/IEC 61643-21	55.0 V			
C1 test 1 kV, 1.2/50 μ s, 0.5 kA 8/20 μ s to BS EN/EN/IEC 61643-21	42.0 V			
B2 test 4 kV 10/700 μ s to BS EN/EN/IEC 61643-21	27.2 V			
5 kV, 10/700 μ s ⁽⁴⁾	28.2 V			
Maximum surge current				
D1 test 10/350 μ s to BS EN/EN/IEC 61643-21:	- Per signal wire	2.5 kA	1.25 kA	2.5 kA
8/20 μ s to ITU-T K.45:2003, IEEE C62.41.2:2002:	- Per pair	5 kA	2.5 kA	5 kA
	- Per signal wire	10 kA		
	- Per pair	20 kA		
Mechanical specification	ESP RS485	ESP SL RS485	ESP RS485Q	
Temperature range	-40 to +80 °C			
Connection type	Screw terminal - max. torque 0.5 Nm	Screw terminal - max. torque 0.8 N	Pluggable 12 way screw terminal	
Conductor size (stranded)	2.5 mm ²	4 mm ²	2.5 mm ²	
Earth connection	M6 stud	Via DIN rail or 4 mm ² earth terminal - max. torque 0.8 Nm	Via DIN rail or M5 threaded hole in base of unit	
Case Material	FR Polymer UL-94 V-0			
Weight: - Unit	0.08 kg		0.1 kg	
- Packaged (per 10)	0.85 kg		1.3 kg	
Dimensions	See diagram below			

⁽¹⁾ Nominal voltage (RMS/DC or AC peak) measured at < 10 μ A

⁽²⁾ Maximum working voltage (RMS/DC or AC peak) measured at < 5 mA

⁽³⁾ The maximum transient voltage let-through of the protector throughout the test ($\pm 10\%$), line to line & line to earth, both polarities. Response time < 10 ns

⁽⁴⁾ Test to IEC 61000-4-5:2006, ITU-T (formerly CCITT) K.20, K.21 and K.45, Telcordia GR-1089-CORE, Issue 2:2002, ANSI TIA/EIA/IS-968-A:2002 (formerly FCC Part 68)

ESP RS485

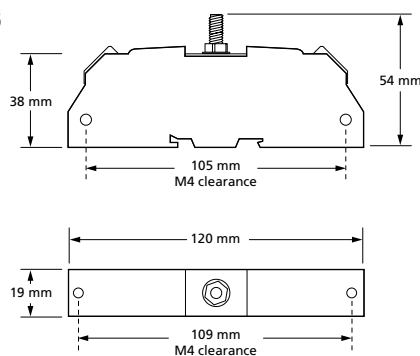

ESP RS485Q

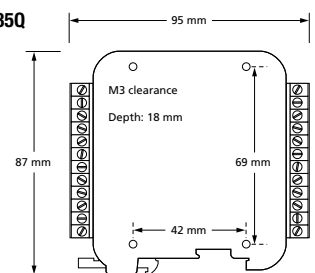

ESP SL RS485

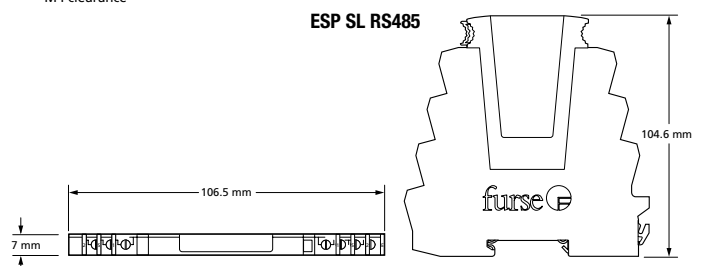



Electronic systems protection

Telecoms & computer line protection





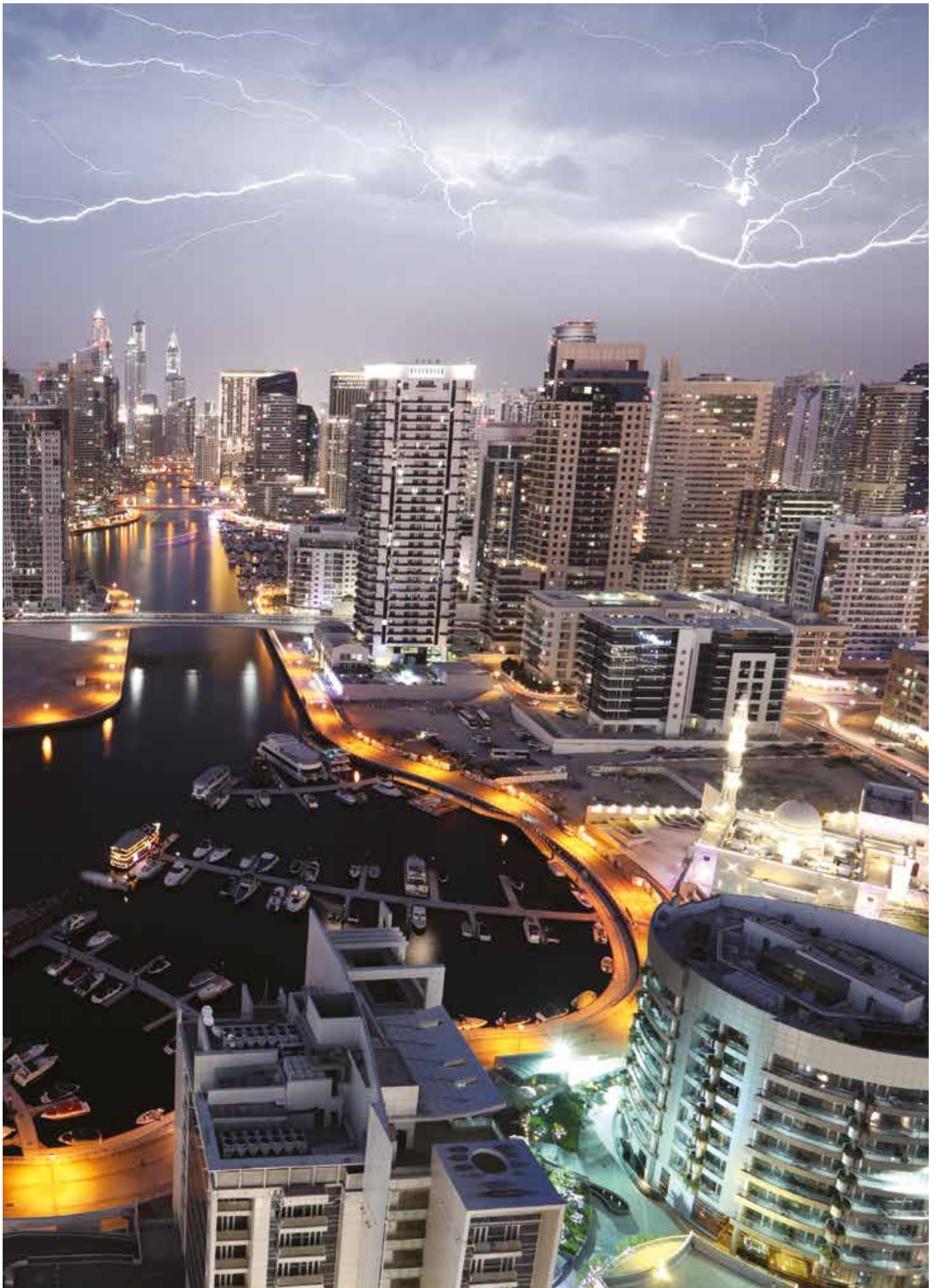

Telecoms & computer line protection

Product selector - Telecommunication / Computer systems	13/2
ESP TN/JP, TN/RJ11 & ISDN/RJ45 Series	13/4
ESP KT & KE Series	13/6
ESP Cat-5 & Cat-6 Series	13/8
ESP LA & LB Series	13/10
ESP LN Series	13/12



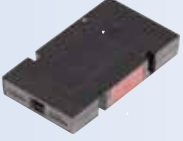

Telecoms & computer line protection

Product selector - Telecommunications / Computer systems

Selection guide - Telecommunications /Computer systems	Installation locations	
Common applications	Service entrance	Critical terminal equipment - located >20 m from service entrance
<p>Analogue Telecom systems Twisted pair data protection see Furse Application Note AN005) Standard, for twisted pair lines</p>	 <p>ESP TN Series ESP TN/BX Series ESP TN/2BX Series See pages 12/4 & 12/10</p>	
<p>Compact, ideal where space is a premium</p>	 <p>ESP SL TN Series See page 12/12</p>	<p>ESP MC/TN/RJ11 Series e.g. Fax machines / Modems See page 12/24</p>
<p>Multiple line protection in a single unit</p>	 <p>ESP TNQ Series See page 12/20</p>	
<p>For BT type socket systems</p>	 <p>ESP TN/JP Series See page 13/4</p>	
<p>For PBX systems terminating of LSA-Plus disconnection modules</p>	 <p>ESP KT Series See page 13/6</p>	

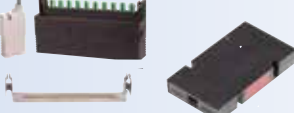
Protectors for specific systems

System	Protector
<p>ISDN telecom systems see Furse Application Note, Note AN002, AN005)</p>	 <p>ESP KT2 Series ESP ISDN Series See pages 13/6 & 13/4</p>
<p>Coaxial CCTV systems</p>	 <p>ESP CCTV/B Series See pages 4/14</p>
<p>Cable TV systems (see Furse Application Note AN006)</p>	 <p>ESP TV Series See pages 14/12</p>
<p>Telecom interfaces at PCB level (see Furse Application Note AN003)</p>	 <p>ESP PCB Series See pages 12/24 & 12/26</p>

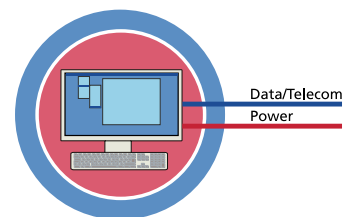

WARNING Equipment is **ONLY** protected if all incoming lines have protection fitted

Telecoms & computer line protection

ESP TN/JP, TN/RJ11 & ISDN/RJ45 Series



LPZ 0→3	FULL MODE Bonding + Equipment Protection	SIGNAL/ TELECOM TEST CAT D + C + B	ENHANCED Low let-through voltage	LOW IN-LINE RESISTANCE 4.4 Ω	CURRENT RATING 300 mA
-------------------	--	---	---	--	-------------------------------------

Combined Category D, C, B tested protector (to BS EN 61643) suitable to protect telephony equipment plugged into a BT telephone (BS 6312), Modem (RJ11) or ISDN (RJ45) socket. For use at boundaries up to LPZ 0 to protect against flashover (typically the service entrance location) through to LPZ 3 to protect sensitive electronic equipment.

Features & benefits

- Very low let-through voltage (enhanced protection to IEC/BS EN 62305) between all lines - Full Mode protection
- Full Mode design capable of handling partial lightning currents as well as allowing continual operation of protected equipment
- Repeated protection in lightning intense environments
- Substantial earth connection to enable effective earthing
- Supplied in a sturdy ABS housing ready for flat mounting, or vertically via TS35 'Top Hat' DIN rail
- ESP TN/JP, ESP TN/RJ11-2/6, ESP TN/RJ11-4/6 and ESP TN/RJ11-6/6 are suitable for telecommunication applications in accordance with Telcordia and ANSI Standards (see Application Note AN005)

Application

- For PSTN (e.g. POTS, dial-up, lease line, T1/E1, *DSL and Broadband) use ESP TN/JP or TN/RJ11
- ESP TN/JP and ESP TN/RJ11... are suitable for use on telephone lines with a maximum (or ringing) voltage of up to 296 Volts
- For telephone lines with a British style, jack plug and socket connection, use ESP TN/JP
- For telephone lines with RJ11 connections protect the middle 2 (of 6) conductors with ESP TN/RJ11-2/6, the middle 4 (of 6) with ESP TN/RJ11-4/6 or all 6 with ESP TN/RJ11-6/6
- For S/T interface ISDN lines, use ESP ISDN/RJ45-4/8 and ESP ISDN/RJ45-8/8
- For S/T interface ISDN lines with RJ45 connections protect the middle 4 (of 8) conductors (paired 3&6, 4&5) with ESP ISDN/RJ45-4/8, or all 8 (outside pairs 1&2, 7&8) with ESP ISDN/RJ45-8/8

For further information on RJ45 ISDN applications, see separate Application Note AN002 and for global telephony applications, see separate Application Note AN005 (contact us for a copy).

Installation

Connect in series with the telephone or ISDN line. These units are usually installed close to the equipment being protected and within a short distance of a good electrical earth.

Accessories

ESP CAT5e/UTP-1

1 metre cable with RJ45 connections

Full product range order codes can be found on pages 17/8-17/9

Plug-in series connection for ESP TN/JP



Plug-in series connection for ESP TN/RJ11-2/6, 4/6 & 6/6



Plug-in series connection for ESP ISDN/RJ45-4/8 & 8/8

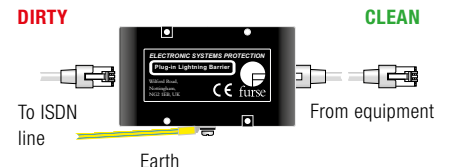

NOTE: For non-ISDN wire-in applications the high performance ESP TN or readyboxed derivative ESP TN/BX or ESP TN/2BX can be used. Protect PBX telephone exchanges and other equipment with LSA-PLUS connections.

Telecoms & computer line protection

ESP TN/JP, TN/RJ11 & ISDN/RJ45 Series

ESP TN/JP, TN/RJ11 & ISDN/RJ45 Series - Technical specification

	ESP TN/JP	ESP TN/ RJ11-2/6	ESP TN/ RJ11-4/6	ESP TN/ RJ11-6/6	ESP ISDN/ RJ45-4/8	ESP ISDN/ RJ45-8/8	
Electrical specification							
ABB order code	7TCA085400R0177	7TCA085400R0178	7TCA085400R0179	7TCA085400R0180	7TCA085460R0170	7TCA085460R0171	
Nominal voltage	296 V	296 V	296 V	296 V	5 V	5 V/58 V ⁽²⁾	
Maximum working voltage $U_c^{(1)}$	296 V	296 V	296 V	296 V	58 V	58 V	
Current rating (signal)	300 mA						
In-line resistance (per line $\pm 10\%$)	4.4 Ω						
Bandwidth (-3 dB 50 Ω system)	20 MHz	20 MHz	20 MHz	20 MHz	19 MHz	19 MHz	
Transient specification							
Let-through voltage (all conductors)⁽³⁾ Up							
C2 test 4 kV 1.2/50 μ s, 2 kA 8/20 μ s to	– line to line	395 V	395 V	395 V	395 V	28 V	28 V/88 V ⁽⁵⁾
BS EN/EN/IEC 61643-21	– line to earth	395 V	395 V	395 V	395 V	88 V	88 V
C1 test 1 kV, 1.2/50 μ s, 0.5 kA 8/20 μ s to	– line to line	390 V	390 V	390 V	390 V	23 V	23 V/63 V ⁽⁵⁾
BS EN/EN/IEC 61643-21	– line to earth	390 V	390 V	390 V	390 V	63 V	63 V
B2 test 4 kV 10/700 μ s to	– line to line	298 V	298 V	298 V	298 V	26 V	26 V/65 V ⁽⁵⁾
BS EN/EN/IEC 61643-21	– line to earth	298 V	298 V	298 V	298 V	65 V	65 V
5 kV, 10/700 μ s ⁽⁴⁾	– line to line	300 V	300 V	300 V	300 V	27 V	27 V/80 V ⁽⁵⁾
	– line to earth	300 V	300 V	300 V	300 V	80 V	80 V
Maximum surge current⁽⁶⁾							
D1 test 10/350 μ s to BS EN/EN/IEC 61643-21	1 kA						
8/20 μ s to ITU-T K.45:2003, IEEE C62.41.2:2002:	10 kA						
Mechanical specification							
Temperature range	-40 to +80 °C						
Connection type	Standard BT jack plug and socket (to BS 6312)	RJ11 plug and socket	RJ11 plug and socket	RJ11 plug and socket	RJ45 plug and socket	RJ45 plug and socket	
Earth connection	M4/DIN rail						
Case Material	FR Polymer UL-94 V-0						
Weight: – Unit	0.15 kg						
– Packaged	0.2 kg						
Dimensions	See diagram below						

⁽¹⁾ Maximum working voltage (DC or AC peak) measured at < 10 μ A leakage for ESP TN/JP and ESP TN/RJ11 products and μ A for ESP ISDN/RJ45 products

⁽²⁾ Maximum working voltage is 5 V for pairs 3/6 & 4/5, and 58 V for pairs 1/2 & 7/8

⁽³⁾ The maximum transient voltage let-through of the protector throughout the test ($\pm 10\%$), line to line & line to earth, both polarities. Response time < 10 ns

⁽⁴⁾ Test to IEC 61000-4-5:2006, ITU-T (formerly CCITT) K.20, K.21 and K.45, Telcordia GR-1089-CORE, Issue 2:2002, ANSI TIA/EIA/IS-968-A:2002 (formerly FCC Part 68)

⁽⁵⁾ The first let-through voltage value is for pairs 3/4 & 5/6, and the second value is for pairs 1/2 & 7/8

⁽⁶⁾ The installation and connectors external to the protector may limit the capability of the protector

ESP TN/JP
cable length: 1 m

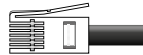

ESP ISDN/RJ45-4/8, 8/8
cable length: 0.5 m



ESP TN/RJ11-2/6, 4/6, 6/6
cable length: 1 m

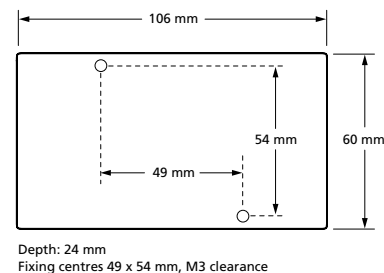

Telecoms & computer line protection

ESP KT & KE Series

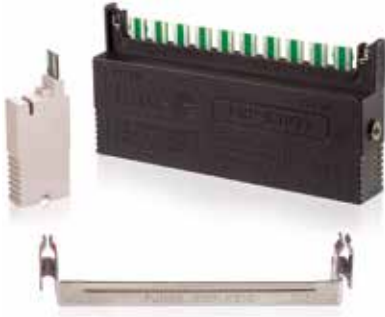

Combined Category D, C, B tested protector (to BS EN 61643) suitable for use on ten line LSA-PLUS disconnection modules to PBX telephone exchanges, ISDN and other telecoms equipment with LSA-PLUS disconnection modules. For use at boundaries up to LPZ 0 to protect against flashover (typically the service entrance location) through to LPZ 3 to protect sensitive electronic equipment.

Features & benefits

- Low cost protection for large numbers of data and signal lines
- Very low let-through voltage (enhanced protection to IEC/BS EN 62305) between all lines - Full Mode protection
- Full Mode design capable of handling partial lightning currents as well as allowing continual operation of protected equipment
- Repeated protection in lightning intense environments
- Colour of housing distinguishes electrically different protectors - avoids confusion when installed together on the same distribution frame
- Quick and easy plug-in installation, with 'bump' location feedback
- Under power line cross conditions /PTC versions offer safe disconnection during fault duration. Unit auto-resets once fault corrected
- At larger installations ESP K10T1/2 and ESP K10T1/PTC provide all in one protection for all ten lines on LSA-PLUS disconnection modules
- Use the ESP KE10 to provide trouble free earthing for up to ten ESP KT1/2 and ESP KT1/PTC (per disconnection module)
- ESP K10T1/2 and ESP K10T1/PTC have an integral earth connection, and an external M4 earth bush for use with non-metallic LSA-Plus frames
- ESP KT1/PTC and ESP K10T1/PTC have resettable overcurrent protection and are rated for power cross faults
- ESP KT1, ESP KT1/PTC, ESP K10T1 and ESP K10T1/PTC are suitable for telecoms applications in accordance with Telcordia and ANSI Standards

Application

- For PSTN (e.g POTS, dial-up, lease line, T1/E1, *DSL and Broadband) and U interface ISDN lines, use ESP KT1 (or ESP KT1/PTC) and ESP K10T1 (or ESP K10T1/PTC)
- For S/T interface ISDN lines, use ESP KT2 and ESP K10T2
- Protect single lines with ESP KT1, ESP KT2 or ESP KT1/PTC
- Protect all ten lines on a disconnection module with ESP K10T1/2

Full product range order codes can be found on pages 17/8-17/9

Installation

Install protectors on all lines that enter or leave each building (including extensions to other buildings). Identify the lines requiring protection and plug-in the protector (ensuring the correct orientation) for a series connection. Plug ESP K10T1/2 directly into each disconnection module requiring protection.

ESP KT1/2 and ESP KT1/PTC must be installed via the ESP KE10 earth bar. Clip an ESP KE10 on to the disconnection module and plug an ESP KT1/2 or ESP KT1/PTC in to each line on the module that needs protecting. In the unlikely situation that the protector is damaged, it will sacrifice itself and fail short circuit, taking the line out of commission, indicating it needs replacing and preventing subsequent transients from damaging equipment.

For further information on global telephony applications, see separate Application Note AN005 (contact us for a copy).

NOTE: For individual telephone lines and lines at unmanned sites the high performance ESP TN, ready-boxed derivative ESP TN/BX or ESP TN/2BX, or plug-in ESP TN/JP or ESP TN/RJ11 Series should be used. For plug-in S/T interface ISDN protection, use the ESP TN or ISDN Series protectors.

Telecoms & computer line protection

ESP KT & KE Series

ESP KT & KE Series - Technical specification

Electrical specification	ESP KT1	ESP KT1/PTC	ESP KT2	ESP K10T1	ESP K10T1/PTC	ESP K10T2	
ABB order code	7TCA085400R0135	7TCA085400R0034	7TCA085400R0136	7TCA085400R0130	7TCA085400R0131	7TCA085400R0133	
Maximum working voltage $U_c^{(1)}$							
– line to line	296 V	296 V	5 V	296 V	296 V	5 V	
– line to earth	296 V	296 V	58 V	296 V	296 V	58 V	
Current rating (signal)	300 mA	145 mA	300 mA	300 mA	145 mA	300 mA	
In-line resistance (per line $\pm 10\%$)	4.4 Ω						
Bandwidth (-3 dB 50 Ω system)	20 MHz	20 MHz	20 MHz	20 MHz	19 MHz	19 MHz	
Transient specification	ESP KT1	ESP KT1/PTC	ESP KT2	ESP K10T1	ESP K10T1/PTC	ESP K10T2	
Let-through voltage (all conductors)⁽²⁾ Up							
C2 test 4 kV 1.2/50 μ s, 2 kA 8/20 μ s to BS EN/EN/IEC 61643-21	– line to line	395 V	395 V	28 V	395 V	395 V	28 V
	– line to earth	395 V	395 V	88 V	395 V	395 V	88 V
C1 test 1 kV, 1.2/50 μ s, 0.5 kA 8/20 μ s to BS EN/EN/IEC 61643-21	– line to line	390 V	390 V	23 V	390 V	390 V	23 V
	– line to earth	390 V	390 V	63 V	390 V	390 V	63 V
B2 test 4 kV 10/700 μ s to BS EN/EN/IEC 61643-21	– line to line	298 V	298 V	26 V	298 V	298 V	26 V
	– line to earth	298 V	298 V	65 V	298 V	298 V	65 V
5 kV, 10/700 μ s ⁽³⁾	– line to line	300 V	300 V	27 V	300 V	27 V	27 V
	– line to earth	300 V	300 V	80 V	300 V	80 V	80 V
Maximum surge current⁽⁴⁾							
D1 test 10/350 μ s to BS EN/EN/IEC 61643-21:	– line to line	1 kA					
	– line to earth	2 kA					
8/20 μ s to ITU-T K.45:2003, IEEE C62.41.2:2002:	– line to line	5 kA					
	– line to earth	10 kA					
Power Faults specification	ESP KT1	ESP KT1/PTC	ESP KT2	ESP K10T1	ESP K10T1/PTC	ESP K10T2	
Power/Line Cross and Power Induction - tests to: ITU-T (formerly CCITT) K.20, K.21 and K.45, Telcordia GR-1089-CORE, Issue 2:2002, UL 60950/IEC 950							
Power/line cross	–	110/230 Vac (15 min)	–	–	110/230 Vac (15 min)	–	
Power induction	–	600 V, 1 A (0.2 sec)	–	–	600 V, 1 A (0.2 sec)	–	
Mechanical specification	ESP KT1, ESP KT2, ESP KT1/PTC		ESP K10T1, ESP K10T2, ESP K10T1/PTC		ESP KE10		
Temperature range	-40 to +80 °C				–		
Connection type	To LSA-PLUS disconnection modules (BT part number 237A)				–		
Earth connection	Via ESP KE10 earth bar		Via integral earth clip/external M4 bush		–		
Material	FR Polymer UL-94 V-0				Stainless Steel		
Weight: – Unit	0.01 kg		0.10 kg		0.01 kg		
– Packaged	0.12 kg (per 10)		0.12 kg		0.10 kg (per 10)		
Dimensions	See diagram below						

⁽¹⁾ Maximum working voltage (DC or AC peak) at 10 μ A for ESP KT1, ESP KT1/PTC, ESP K10T1, ESP K10T1/PTC and at 5 μ A for ESP KT2 and ESP K10T2

⁽²⁾ The maximum transient voltage let-through of the protector throughout the test ($\pm 10\%$), line to line & line to earth, both polarities. Response time < 10 ns

⁽³⁾ Test to IEC 61000-4-5:2006, ITU-T (formerly CCITT) K.20, K.21 and K.45, Telcordia GR-1089-CORE, Issue 2:2002, ANSI TIA/EIA/IS-968-A:2002 (formerly FCC Part 68)

⁽⁴⁾ The installation and connections external to the protector may limit the capability of the protector

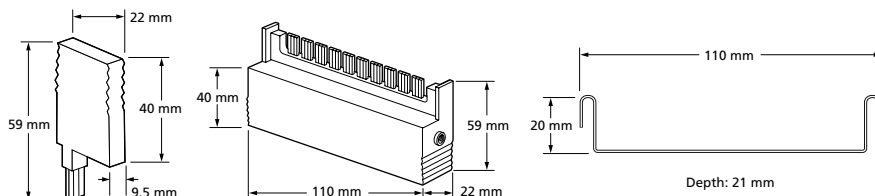

Telecoms & computer line protection

ESP Cat-5 & Cat-6 Series



LPZ 0→3	FULL MODE Bonding + Equipment Protection	SIGNAL/ TELECOM TEST CAT D + C + B	ENHANCED Low let-through voltage	LOW IN-LINE RESISTANCE 1.5 Ω	HIGH CURRENT RATING	PoE+ Compliant IEEE 802.3at	PoE Modes A & B
-------------------	--	---	---	--	------------------------------------	--	------------------------------

Combined Category D, C, B tested protector (to BS EN 61643) suitable to protect twisted pair Ethernet networks, including Power over Ethernet (PoE), with RJ45 connections. For use at boundaries up to LPZ 0 to protect against flashover (typically the service entrance location) through to LPZ 3 to protect sensitive electronic equipment.

Features & benefits

- Suitable for systems signalling on up to eight wires of either shielded or unshielded twisted pair cable
- Very low let-through voltage (enhanced protection to IEC/BS EN 62305) between all lines - Full Mode design capable of handling partial lightning currents as well as allowing continual operation of protected equipment
- Repeated protection in lightning intense environments
- Unlike some competing devices, the ethernet SPDs provide effective protection without impairing the system's normal operation
- Low capacitance circuitry prevents the start-up signal degradation associated with other types of network protector
- Low in-line resistance minimizes unnecessary reductions in signal strength to maximize signalling distance
- Sturdy ABS housing with convenient holes for flat mounting, or vertically via TS35 'Top Hat' DIN rail
- Substantial earth connection to enable effective earthing
- Will protect all PoE powering modes A and B.

Application

Use these protectors on network cables that travel between buildings to prevent damage to equipment, e.g. computers, servers, repeaters and hubs. Suitable for computer networks up to Cat-6A cabling.

- To protect up to 100baseT networks with Cat-5/Cat-5e cabling use ESP Cat-5e
- To protect up to 1000baseT/ 10GbaseT networks with Cat-6/Cat-6A cabling use ESP Cat-6

- To protect up to 100baseT Power over Ethernet (PoE) networks with Cat-5/Cat-5e use ESP Cat-5e/PoE
- To protect up to 1000baseT/ 10GbaseT Power over Ethernet (PoE) networks with Cat-6/Cat-6A cabling use ESP Cat-6/PoE

For further application information, see separate Application Note AN004 (contact us for a copy).

Installation

Connect in series with the network cable, either:

- Near to where it enters or leaves the building, or
- As it enters the network hub, or
- Close to the equipment being protected

This should be close to the system's earth star point (to enable a good connection to earth).

Accessories

ESP CAT5e/UTP-1

1 metre cable with unshielded RJ45 connections

ESP CAT6/STP-2

2 metre screened cable with shielded RJ45 connections

Full product range order codes can be found on pages 17/8-17/9

Plug-in series connection



TECHNICAL NOTE: The interfaces used in Ethernet networks incorporate an isolation transformer which gives these systems an inbuilt immunity to transients between line and earth of 1,500 Volts or more.

NOTE: To protect datacomms systems based on twisted pairs, use the ESP D, E or H Series. Local protection for networked equipment is also available. For protection of legacy coaxial Ethernet networks, please contact us for details of our ESP ThinNet and ESP ThickNet protectors.

Telecoms & computer line protection

ESP Cat-5 & Cat-6 Series

ESP Cat-5 & Cat-6 Series - Technical specification

Electrical Specification		ESP Cat-5e	ESP Cat-5e/PoE	ESP Cat-6	ESP Cat-6/PoE
ABB order code		7TCA085400R0017	7TCA085400R0021	7TCA085400R0023	7TCA085400R0024
Maximum working voltage $U_c^{(1)}$	- data ⁽²⁾ - power ⁽³⁾	5 V	58 V	58 V	58 V
Current rating		300 mA	600 mA ⁽⁴⁾	300 mA	600 mA ⁽⁴⁾
In-line resistance (per line $\pm 25\%$)	- data ⁽²⁾ - power	1.5 Ω	1.5 Ω	-	-
Maximum data rate		100 Mbps	100 Mbps	1000 Mbps	1000 Mbps
Networking standards:		10/100baseT	10/100baseT	10/100/1000/ 10GbaseT	10/100/1000/ 10GbaseT
		TIA Cat-5e	TIA Cat-5/PoE	TIA Cat-6	TIA Cat-6
		IEEE 802.3i	IEEE 802.3i	IEEE 802.3i	IEEE 802.3i
		IEEE 802.3u	IEEE 802.3u	IEEE 802.3u	IEEE 802.3u
		-	IEEE 802.3af	IEEE 802.3ab	IEEE 802.3ab
		-	IEEE 802.3at	IEEE 802.3an	IEEE 802.3an
		-	-	-	IEEE 802.3af
		-	-	-	IEEE 802.3at
Transient specification		ESP Cat-5e	ESP Cat-5e/PoE	ESP Cat-6	ESP Cat-6/PoE
Let-through voltage (all conductors)⁽⁵⁾ Up					
C2 test 4 kV 1.2/50 μ s, 2 kA 8/20 μ s to BS EN/EN/IEC 61643-21	- line to line - line to earth ⁽⁶⁾	120 V	120 V/116 V ⁽⁶⁾	120 V	120 V/116 V ⁽⁶⁾
C1 test 1 kV, 1.2/50 μ s, 0.5 kA 8/20 μ s to BS EN/EN/IEC 61643-21	- line to line - line to earth ⁽⁶⁾	74 V	74 V/95 V ⁽⁶⁾	74 V	74 V/95 V ⁽⁶⁾
B2 test 4 kV 10/700 μ s to BS EN/EN/IEC 61643-21	- line to line - line to earth ⁽⁶⁾	21 V	21 V/87 V ⁽⁶⁾	21 V	21 V/87 V ⁽⁶⁾
5 kV, 10/700 μ s ⁽⁷⁾	- line to line - line to earth ⁽⁶⁾	25 V	25 V/90 V ⁽⁶⁾	25 V	25 V/90 V ⁽⁶⁾
Maximum surge current⁽⁹⁾					
D1 test 10/350 μ s to BS EN/EN/IEC 61643-21		1 kA			
8/20 μ s to ITU-T K.45:2003, IEEE C62.41.2:2002		10 kA			
Mechanical specification		ESP Cat-5e, ESP Cat-5e/PoE		ESP Cat-6, ESP Cat-6/PoE	
Temperature range		-40 to +80 °C			
Connection type		RJ45 sockets			
Cable (supplied)		0.5 m Cat-5e UTP patch lead		0.5 m Cat-6 STP patch lead	
Earth connection		M4/DIN rail			
Case Material		FR Polymer UL-94 V-0			
Weight: - Unit		0.15 kg			
- Packaged		0.2 kg			
Dimensions		See diagram below			

⁽¹⁾ Maximum working voltage (DC or AC peak) measured at 1 mA leakage

⁽²⁾ Data pairs 1/2 and 3/6 are protected as standard. Pairs 4/5 and 7/8 are also protected on Cat-6 barriers

⁽³⁾ PoE protectors transmit power Mode A and Mode B power

⁽⁴⁾ Based on 30W of transmitted PSE power, to IEEE 802.3at.

⁽⁵⁾ The maximum transient voltage let-through of the protector throughout the test ($\pm 10\%$), line to line & line to earth. Response time <10 ns (on all protected pairs)

⁽⁶⁾ The interfaces used in network systems incorporate an isolation transformer that inherently provides an inbuilt immunity to transients between line and earth of 1,500 Volts or more

⁽⁷⁾ Test to IEC 61000-4-5:2014, ITU-T (formerly CCITT) K.20, K.21 and K.45, Telcordia GR-1089-CORE, Issue 6:2011, ANSI TIA/EIA/IS-968-A:2005 (formerly FCC Part 68).

⁽⁸⁾ The first number is for the data pair, with the second number for the power pair

⁽⁹⁾ The installation and connectors may limit the capability of the protector

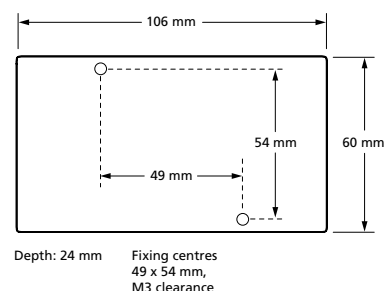

Telecoms & computer line protection

ESP LA & LB Series

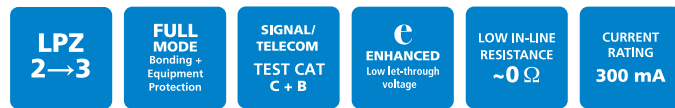

Combined Category C, B tested protector (to BS EN 61643) suitable to protect PCs and other computer equipment on systems using 9, 15 or 25 pins. For use on lines running within buildings at boundaries up to LPZ 2 through to LPZ 3 to protect sensitive electronic equipment.

Features & benefits

- Let-through voltage below equipment susceptibility levels
- Negligible in-line resistance
- Suitable for equipment using “D” connectors - DB-9, DB-15 and DB-25
- ESP LA-5/25 protects pins 1, 2, 3, 7 & 20 to earth/shell. Note pin 1 is connected to earth
- ESP LA-25/25 and ESP LB-25/25 protects all pins. Note pin 1 is connected to earth/shell
- ESP LA-9/9, ESP LB-9/9, ESP LA-15/15 and ESP LB-15/15 protect all pins
- Sturdy plastic housing
- Male/female connectors allow easy plug-in installation without rewiring
- Earthed via shell and supplementary earth strap

Application

Use on cables running within a building to protect equipment locally from transients induced on to data cables from the magnetic field caused by a lightning strike.

- For Asynchronous RS 232 systems, use ESP LA-5/25
- For RS 232 systems, use ESP LA-25/25, ESP LA-9/9 or ESP LA-15/15
- For RS 422, RS 423 and RS 485 systems, use ESP LB-9/9, ESP LB-15/15 or ESP LB-25/25

Installation

Simple plug-in connection to the communication port, between the equipment to be protected and its incoming data cable. Make suitable attachment to earth.

Full product range order codes can be found on pages 17/8-17/9

TECHNICAL NOTE: ESP LA... and ESP LB... protectors are designed only for use on cables running within a building (typically LPZ 2) to offer local protection to equipment. They therefore will not be able to handle the higher level transients that occur when lines between buildings are protected. ESP LA... and ESP LB... protectors should not be used in such an application (up to LPZ 0) where high energy ESP lightning barriers (such as ESP E Series) should be employed. If they are used in lines between buildings, there is a high risk of the protector being overloaded and destroyed during transient activity. Connected equipment will, in most cases, still be protected, but there is a small risk that equipment will suffer damage in such circumstances.

NOTE: For cabling up to Cat-6 with RJ45 connections (running external to the building) and local protection for up to Cat-6 with RJ45 connections, (running within a building) products are also available. For protection of legacy coaxial Ethernet networks, please contact us for details of our ESP ThinNet and ESP ThickNet protectors.

Telecoms & computer line protection

ESP LA & LB Series

ESP LA & LB Series - Technical specification

Electrical specification	ESP LA-5/25	ESP LA-25/25	ESP LA-9/9	ESP LB-9/9	ESP LA-15/15	ESP LB-15/15	ESP LB-25/25
ABB order code	7TCA085400R0139	7TCA085400R0138	7TCA085400R0140	7TCA085400R0143	7TCA085400R0137	7TCA085400R0141	7TCA085400R0142
Nominal voltage ⁽¹⁾	23.1 V	23.1 V	23.1 V	5.8 V	15.3 V	6.4 V	5.8 V
Maximum working voltage U_c (RMS/DC) ⁽²⁾	25.7 V	25.7 V	25.7 V	6.4 V	17.1 V	7.13 V	6.4 V
Capacitance	< 500 pF	< 500 pF	< 500 pF	< 2000 pF	< 50 pF	< 50 pF	< 2000 pF
Current rating	300 mA						
In-line resistance	~ 0 Ω						
Transient specification	ESP LA-5/25	ESP LA-25/25	ESP LA-9/9	ESP LB-9/9	ESP LA-15/15	ESP LB-15/15	ESP LB-25/25
Let-through voltage⁽³⁾ Up							
C2 test 4 kV 1.2/50 μ s, 2 kA 8/20 μ s to BS EN/EN/IEC 61643-21	–	–	–	12.5 V	31.5 V	16.0 V	12.5 V
B2 test 1 kV 10/700 μ s to BS EN/EN/IEC 61643-21	36.5 V	36.5 V	36.5 V	10.0 V	27.5 V	14.0 V	10.0 V
5 kV, 10/700 μ s ⁽⁴⁾	37.5 V	37.5 V	37.5 V	10.5 V	28.5 V	14.6 V	10.5 V
Protection provided	Pins 1, 2, 3, 7 and 20 to earth/shell ⁽⁵⁾	Pins 1-25 to earth/shell ⁽⁵⁾	Pins 1-9 to earth/shell	Pins 1-9 to earth/shell	Pins 1-15 to earth and each other	Pins 1-15 to earth and each other	Pins 1-25 to earth/shell ⁽⁵⁾
Maximum surge current							
8/20 μ s to ITU-T K.45:2003, IEEE C62.41.2:2002	200 A	200 A	200 A	300 A	350 A	700 A	300 A
Mechanical specification	ESP LA-5/25	ESP LA-25/25	ESP LA-9/9	ESP LB-9/9	ESP LA-15/15	ESP LB-15/15	ESP LB-25/25
Temperature range	-40 to +80 °C						
Connection type	DB-25 m-f	DB-25 m-f	DB-9 m-f	DB-9 m-f	DB-15 m-f	DB-15 m-f	DB-25 m-f
Earth connection	Shell or 150 mm earth lead (supplied)						
Case Material	FR Polymer UL-94 V-0						
Weight: – Unit	50 g	50 g	40 g	40 g	50 g	50 g	50 g
– Packaged	70 g	70 g	50 g	50 g	60 g	60 g	70 g
Dimensions	See diagram below						

⁽¹⁾ Nominal voltage (RMS/DC or AC peak) measured at 5 μ A (ESP LA-5/25, ESP LA-9/9, ESP LA-25/25, ESP LA-15/15), 0.5 mA (ESP LB-15/15) and 1 mA (ESP LB-9/9, ESP LB-25/25)

⁽²⁾ Maximum working voltage (RMS/DC or AC peak) measured at 1 mA leakage (ESP LA-5/25, ESP LA-9/9, ESP LA-25/25, ESP LA-15/15) and 10 mA (ESP LB-15/15, ESP LB-9/9 and ESP LB-25/25)

⁽³⁾ The maximum transient voltage let-through of the protector throughout the test ($\pm 10\%$). Response time < 10 ns.

⁽⁴⁾ Test to IEC 61000-4-5:2006, ITU-T (formerly CCITT) K.20, K.21 and K.45, Telcordia GR-1089-CORE, Issue 2:2002, ANSI TIA/EIA/IS-968-A:2002 (formerly FCC Part 68)

⁽⁵⁾ Pin 1 connected to earth/shell

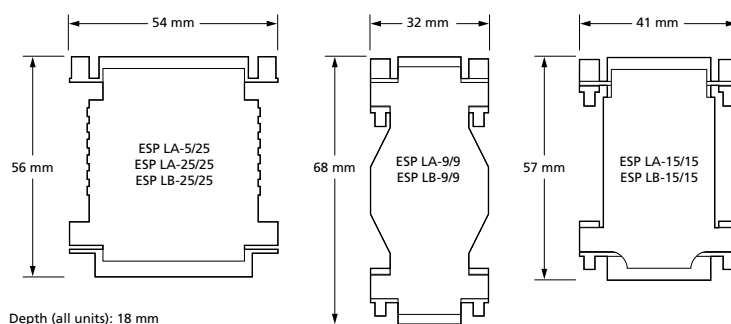

Telecoms & computer line protection

ESP LN Series



LPZ
2→3

FULL
MODE
Bonding +
Equipment
Protection

SIGNAL/
TELECOM
TEST CAT
C + B

ENHANCED
Low let-through
voltage

LOW IN-LINE
RESISTANCE
~0 Ω

CURRENT
RATING
300 mA

Combined Category C, B tested protector (to BS EN 61643) suitable to protect equipment on twisted pair applications using Cat-5 wiring with RJ45 connectors. For use on lines running within buildings at boundaries up to LPZ 2 through to LPZ 3 to protect sensitive electronic equipment.

Features & benefits

- Suitable for systems signalling on up to 8 wires of unshielded twisted pair cable - protects all 8 pins in each line
- Use to protect 1, 4, 8 or 16 lines
- Suitable for RS 422/423, 10baseT, 100baseT, Token Ring and Fast Ethernet systems
- Available for individual connections or for multiport applications
- Free-standing or 19" rack mounted versions available for multiport applications
- Let-through voltage below equipment susceptibility levels
- Protects twisted pair lines operating at speeds up to 100 Mbps
- Available as 4 or 8 port free-standing versions (ESP LN-4 and ESP LN-8) and 8 or 16 port 19" rack mounted panels (ESP LN-8/16 and ESP LN-16/16)
- Negligible in-line resistance
- Sturdy housing and simple plug-in installation
- Simple earthing via single braided metal strap

Application

Use on network cables running within a building to protect systems locally from transients induced on to data cables from the magnetic field caused by a lightning strike.

Suitable for internal cabling Cat-5.

- Protect the network connection to individual pieces of equipment with the ESP LN
- Protect multiport applications such as hubs, switches and patch panels with the ESP LN-4, ESP LN-8, ESP LN-8/16 or ESP LN-16/16

Installation

Plug-in connection between incoming data cables and equipment to be protected. Make suitable attachment to earth.

Full product range order codes can be found on pages 17/8-17/9

TECHNICAL NOTE: ESP LN... range of protectors are designed only for use on cables running within a building (typically LPZ 2) to offer local protection to equipment. They therefore will not be able to handle the higher level transients that occur when lines between buildings are protected. ESP LN... range of protectors should not be used in such an application (up to LPZ 0) where high energy ESP lightning barriers (such as ESP E and ESP Cat-5 & Cat-6 Series) should be employed. If they are used in lines between buildings, there is a high risk of the protector being overloaded and destroyed during transient activity. Connected equipment will, in most cases, still be protected, but there is a small risk that equipment will suffer damage in such circumstances.

NOTE: Protectors for coaxial (or twisted pair) CCTV Lines are available. For coaxial RF lines, use the ESP RF Series. Transients can also be conducted into TV systems via the mains power supplies - use suitable ESP mains protection.

Telecoms & computer line protection

ESP LN Series

ESP LN Series - Technical specification

Electrical specification	ESP LN	ESP LN-4	ESP LN-8	ESP LN-8/16	ESP LN-16/16
ABB order code	7TCA085400R0145	7TCA085400R0147	7TCA085400R0148	7TCA085400R0149	7TCA085400R0146
Maximum working voltage U_c (RMS/DC) ⁽¹⁾	4 V				
Current rating	300 mA				
In-line resistance	~ 0 Ω				
Bandwidth (-3 dB 50 Ω system)	100 Mbps				
Transient specification	ESP LN	ESP LN-4	ESP LN-8	ESP LN-8/16	ESP LN-16/16
Let-through voltage⁽²⁾ Up					
C2 test 4 kV 1.2/50 μ s, 2 kA 8/20 μ s to BS EN/EN/IEC 61643-21	13.5 V				
B2 test 4 kV 10/700 μ s to BS EN/EN/IEC 61643-21	12.0 V				
1.5 kV, 10/700 μ s ⁽³⁾	12.5 V				
Maximum surge current					
8/20 μ s to ITU-T K.45:2003, IEEE C62.41.2:2002	350 A				
Mechanical specification	ESP LN	ESP LN-4	ESP LN-8	ESP LN-8/16	ESP LN-16/16
Temperature range	-40 to +80 °C				
Connection type	RJ45 sockets				
Earth connection	External earth strap	External earth strap on front fascia panel	External earth strap on front fascia panel	External earth strap through mounting screws	External earth strap through mounting screws
Case Material	FR Polymer UL-94 V-0			Steel	Steel
Weight: - Unit	0.05 kg	0.29 kg	0.32 kg	0.75 kg	1 kg
- Packaged	0.09 kg	0.58 kg	0.61 kg	1.1 kg	1.35 kg
Dimensions	See diagram below				

⁽¹⁾ Maximum working voltage (RMS/DC or AC peak) measured at 1 mA leakage

⁽²⁾ The maximum transient voltage let-through of the protector throughout the test ($\pm 10\%$). Response time < 10 ns

⁽³⁾ Test to IEC 61000-4-5:2006, ITU-T (formerly CCITT) K.20, K.21 and K.45, Telcordia GR-1089-CORE, Issue 2:2002, ANSI TIA/EIA/IS-968-A:2002 (formerly FCC Part 68)

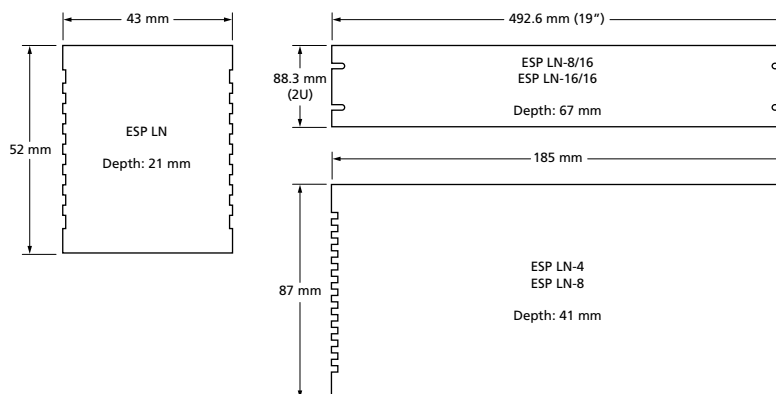



Electronic systems protection

Specific systems protection

Specific systems protection

Introduction	14/2
ESP WT Series	14/6
ESP PV Series	14/8
ESP SSI Series	14/10
ESP TV Series	14/12
ESP CCTV Series	14/14
ESP RF Series	14/16

Specific systems protection

Introduction



Protecting wind turbines - Wind turbines contain a vast array of electronic systems, including power, control and telecoms, which require transient overvoltage protection.



Protection follows the Lightning Protection Zones (LPZ) concept established in IEC/BS EN 62305 and IEC 61400, with equipment sited in internal zones up to LPZ 2 (see Figure 8 & Table 3 for specific locations).

Power line protection

Lightning current/equipotential bonding SPDs (minimum Type 1) are required at LPZ boundary LPZ 0 to LPZ 1 to counter partial lightning currents resulting from a direct lightning strike. Transient overvoltage SPDs (minimum Type 2) are required at LPZ boundary LPZ 1 to LPZ 2 to protect critical electronic systems.

The SPD selected should be suitable for the voltage of the line. Furse ESP WT Series protectors apply at 690 V with Furse ESP D1 Series or Furse ESP M1 Series protectors covering 230 V/400 V lines (see Table 3).

These power line protectors offer low let-through voltage protection creating a safe area downstream of minimum LPZ 2, meeting the requirements for wind turbines.

SPDs should be installed on the line side, as close as possible to the equipment being protected. Where connected downstream equipment is > 10 m away, a second SPD should be installed at the subsequent equipment (in line with guidance in DD CLC/TS 50539-22:2010).

If the main HV transformer is housed separately from the wind turbine, incoming/outgoing lines from the turbine and the HV transformer should be protected (minimum LPZ 0 to LPZ 1, or where control system electronics are installed LPZ 0 to LPZ 2).

Data/signal/telecoms line protection

SPDs should be installed to protect data, signal and telecoms lines in the wind turbine and where appropriate, the HV transformer. A wide range of Furse SPDs are available for this purpose, including the the ESP SL Series and ESP D, E, H Series protectors (see Table 3 for specific application).

The SPD selected should be compatible with the system to be protected, and offer sufficient protection to reduce overvoltages below the immunity threshold of the protected equipment. The SPD must not impede system performance and must be able to survive repeated transients.

Table 3: SPD requirement according to component to be protected

Location	LPZ	SPD required
Generator (690 V)	LPZ 0 to LPZ 1	ESP WT Series protector
Frequency converter (690 V)	LPZ 0 to LPZ 2	ESP WT Series protector
Transformer (690 V)	LPZ 0 to LPZ 1*	ESP WT Series protector
Control system (230 V)	LPZ 0 to LPZ 1	ESP 240 D1 or ESP 240 M1
Aviation warning light (230 V)	LPZ 0 to LPZ 1	ESP 240 D1 or ESP 240 M1
Hub control:	- (230 V)	ESP 240 D1 or ESP 240 M1
	- (4-20 mA loop)	ESP SL RS485
	- (RS 485 line)	ESP SL RS485
Anemometer (24 V)	LPZ 0 to LPZ 1	ESP SL30
Modem	LPZ 0 to LPZ 1	ESP TN or ESP SL TN

*Where the transformer includes process control/data lines, protect to LPZ 2

The SPD should be installed as close as possible to the point of entry/exit of the incoming/outgoing line. Where connected equipment is > 10 m from the incoming/outgoing line, a second SPD should be installed at any subsequent connected equipment.

Application of SPDs within a typical wind turbine environment

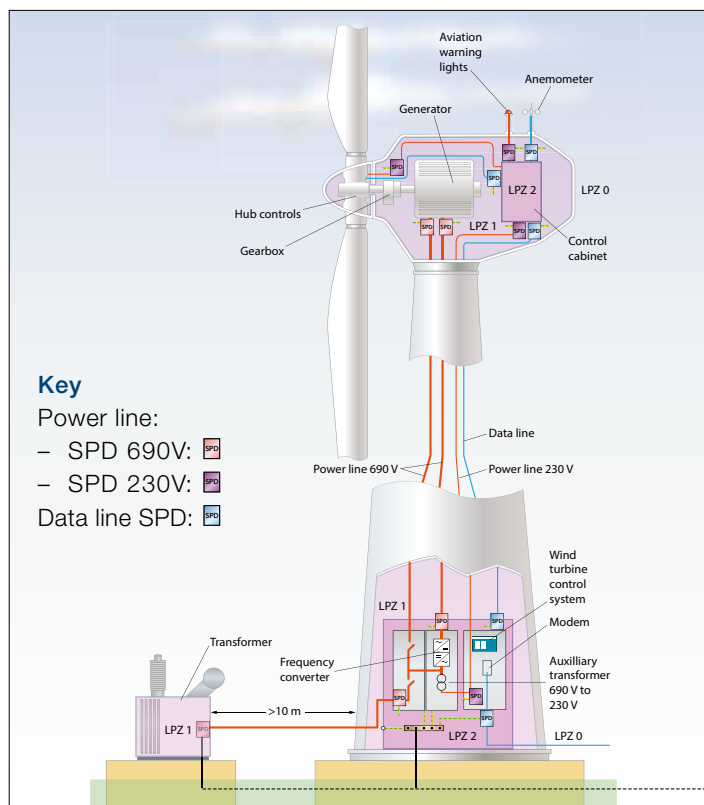

Specific systems protection

Introduction

Table 4: SPD requirement according to structural LPS configuration

Status of Structural LPS	DC side, distance PV array to inverter		AC side of inverter
	< 10 m	> 10 m	
No structural LPS	ESP PV Series protector (min. Type 2 performance)	ESP PV Series protector (min. Type 2 performance)	ESP AC mains power protector (min. Type 2 performance)
Structural LPS (separation distance kept)	ESP PV Series protector (min. Type 2 performance)	ESP WT Series protector (min. Type 2 performance)	ESP AC mains power protector (min. Type 2 performance - inverter) (min. Type 1 performance - MDB)
Structural LPS (separation distance not kept)	ESP PV Series protector (min. Type 1 performance)	ESP PV Series protector (min. Type 1 performance)	ESP AC mains power protector (min. Type 1 performance)

Photovoltaic (PV) systems are at risk from transient overvoltages which may enter the system following a direct lightning strike to a structural LPS, or via the wider electrical network.

Protection against transient overvoltages is achieved through installation of appropriate SPDs on the DC and AC side of the DC-AC inverter in the PV system. Installation should follow the guidance provided in Technical Specification DD CLC/TS 50539-12.

Installation on the DC side of the DC-AC inverter

An SPD specifically designed for use on the DC side of a PV system should be installed. Where the distance between the PV array and the inverter is < 10 m, a single SPD suffices, mounted as close as possible to the inverter. Where the distance > 10 m, two SPDs should be installed, one close to the inverter and the other close to the PV array. The minimum Type of SPD is dependent on presence of structural LPS/ separation distance (see Table 4).

Installation on the AC side of the DC-AC inverter

The presence (or lack) of a structural LPS, plus whether sufficient separation distance has been kept between the LPS and the PV array, defines the SPD requirement on the AC side of the inverter (see Table 4). Where the distance between service entrance (Main Distribution Board (MDB)) and inverter is < 10 m, a single SPD should be installed at the service entrance (MDB). Where > 10 m, two SPDs should be installed, one at the MDB and the other close to the inverter.

Furse Combined Type SPDs for AC mains power circuits are applicable here. The SPD to be installed will be dependent on the Class of LPS around the structure, and the location of the metallic services connected to it (i.e. underground/ exposed overhead supply).

IMPORTANT: This page refers to protection of PV power circuits only. Ensure any data/signal/ telecoms lines connected to the PV system are also appropriately protected.

NOTE: Furse ESP PV Series SPDs offer combined Type 1+2 protection, and therefore apply across all scenarios.

Roof mounted PV array, with external LPS

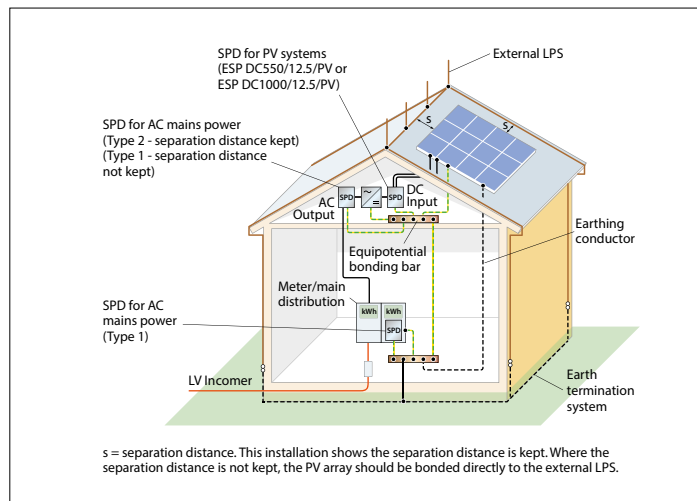

Protection of solar park/PV array

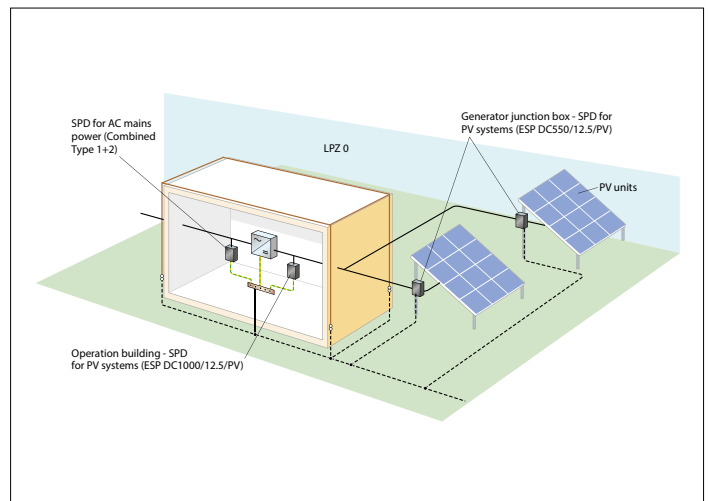

Transient overvoltage protection for rail networks

Location	Requirement	Protection measure (SPD)
Main terminals & stations	Protect 3-phase & 1-phase power supplies	ESP M1 Series ESP D1 Series ESP M2/M4 Series ESP 415/XXX Series
	Protect critical systems (e.g. fire fighting equipment)	ESP 5A/BX & ESP 16A/BX Series
	Protect telecoms systems	ESP D, E, H Series ESP SL Series
Trackside location Cabinets (LOCS)	Protect trackside signalling equipment (SSI systems) & radio network	ESP SSI/M & ESP SSI/B ESP RF Series
	Protect power supplies	SSI/120AC & ESP SSI/140AC ESP M1 Series ESP D1 Series
	Maintain TFMs/SSI datalinks	ESP PTE002 Tester
Level crossings	Protect CCTV systems	ESP 5A/BX & ESP 16A/BX Series ESP CCTV Series ESP D Series
	Signalling equipment & radio network	ESP SSI Series ESP RF Series

Note: list of Surge Protection Measures shown above is not exhaustive. Additional electronic systems may require transient overvoltage protection on a case-by-case basis. Please contact us to discuss particular project requirements.

Safety, reliability and availability of service are essential prerequisites for a rail network.

For all types of network, from mass transit systems and mainline services to metros, airport links and light rail, this has clear implications for the sensitive and critical electronic systems installed throughout.

These systems manage network performance, and ensure its continuous safe and practical operation. Yet they can easily be damaged or degraded by transient overvoltages, caused by:

- Partial lightning currents entering an electrical system following a direct lightning strike to a network location
- Indirect lightning (nearby lightning strikes) to the rail network, leading to transient overvoltages entering an electrical system via a local earthing arrangement (resistive coupling), or via overhead metallic service lines (inductive coupling)

Outright damage to electronic systems causes service interruptions and network downtime leading to customer dissatisfaction and maintenance costs.

Degradation leads to reduced equipment reliability and lower equipment lifetimes, risking sudden, unpredictable or intermittent failures.

Installing protection against transient overvoltages throughout the network is therefore critical. Transient overvoltage protection should be applied on (but not limited to):

- Power supplies throughout the network, including trackside cabinets, level crossings and at stations and terminals
- Signalling networks including trackside Solid State Interlocking (SSI) systems
- Telecommunications equipment and trackside telephones
- CCTV monitoring systems
- Passenger information systems, ticketing and gating operations
- Security systems and critical safety equipment such as fire detection and fire alarm systems

Effective, repeat protection against transient overvoltages can be achieved through installation of Furse Surge Protective Devices as part of an overall Lightning Protection System to IEC/BS EN 62305.

Key protection locations together with the appropriate Furse SPD are shown in the table below. Many of these SPDs have Network Rail approval (see individual product pages for further reference).

Specific systems protection

ESP WT Series

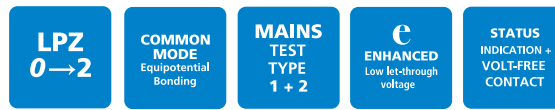

Combined Type 1 and 2 tested protector (to BS EN 61643) for use on the main distribution board within wind turbines, for equipotential bonding. For use at boundaries up to LPZ 0 to protect against flashover (typically the main distribution board location) through to LPZ 2 to protect electrical equipment from damage.

Features & benefits

- Enhanced protection (to IEC/BS EN 62305) offering low let-through voltage further minimizing the risk of flashover creating dangerous sparking or electric shock
- Repeated protection in lightning intense environments
- The varistor based design eliminates the high follow current (I_f) associated with spark gap based surge protection
- Indicator shows when the protector requires replacement
- Remote signal contact can indicate the protector's status through interfacing with a building management system

Application

Use on 690 V three phase mains power supplies and power distribution boards for protection against partial direct and indirect lightning strikes. The services (typically 3 phase 400 V mains, UPS, data, signal and telecom lines) to the cabinet within the wind turbine nacelle will require additional protection.

- For a 3 phase TN-S supply, install 4 ESP WT units together with ESP CE10 or ESP CE13 connecting and earthing bar (see installation)
- For a 3 phase TN-C supply, install 3 ESP WT units together with ESP CE7 or ESP CE9 connecting and earthing bar (see installation)

Installation

Protector should be installed in the main distribution board with connecting leads of minimal length. The protector should be fused and is suitable for attachment to a 35 mm top hat DIN rail. The diagrams below illustrate how to wire the appropriate ESP protector according to your chosen electrical system.

Accessories

Connecting and earthing bars

ESP CE7

Use with 3 of ESP 690/12.5/WT for TN-C supplies

ESP CE9

Use with 3 of ESP 690/25/WT for TN-C supplies

ESP CE10

Use with 4 of ESP 690/12.5/WT for TN-S supplies

ESP CE13

Use with 4 of ESP 690/25/WT for TN-S supplies

For suitable enclosures for the ESP WT series, please contact us.

Full product range order codes can be found on pages 17/8-17/9

TN-S earthing system (ESP WT x 4 with ESP CE10 or ESP CE13 earthing bars

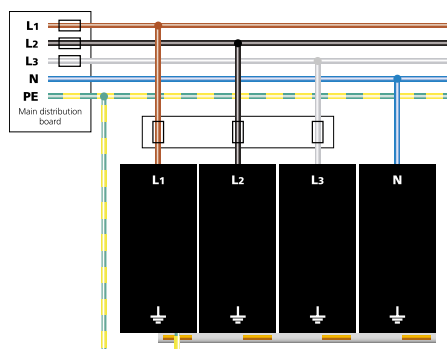

TN-C earthing system (ESP WT x 3) with ESP CE7 or ESP CE9 earthing bars

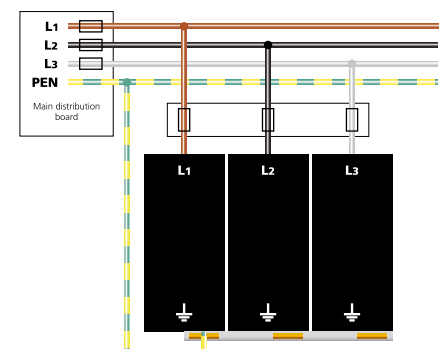

IMPORTANT: The primary purpose of lightning current or equipotential bonding mains Type 1 Surge Protective Devices (SPDs) is to prevent dangerous sparking caused by flashover to protect against the loss of human life. In order to protect electronic equipment and ensure the continual operation of systems, transient overvoltage mains Type 2 and 3 SPDs such as the ESP M1 Series or ESP D1 Series are further required, typically installed at downstream subdistribution boards feeding sensitive equipment. IEC/BS EN 62305 refers to the correct application of mains Type 1, 2 and 3 SPDs as a coordinated set. For further information, please refer to the Furse Guide to BS EN 62305 Protection against Lightning.

Specific systems protection

ESP WT Series

ESP WT Series - Technical specification

Electrical specification	ESP 690/25/WT	ESP 690/12.5/WT
ABB order code	7TCA085460R0028	7TCA085460R0027
Nominal voltage - Phase-Neutral U_0 (RMS)	690 V	
Maximum voltage - Phase-Neutral U_c (RMS/DC)	750 V/1000 V	
Short circuit withstand capability	25 kA/50 Hz	
Max. back-up fuse (see installation instructions)	250 A	
Leakage current (to earth)	< 3.5 mA	< 2.5 mA
Volt free contact:	Screw terminal	
– current rating	0.5 A	
– nominal voltage (RMS)	250 V	
Transient specification	ESP 690/25/WT	ESP 690/12.5/WT
Type 1 (BS EN/EN), Class I (IEC)		
Nominal discharge current 8/20 μ s (per mode) I_n	40 kA	20 kA
Let-through voltage U_p at $I_n^{(1)}$	< 2.5 kV	
Impulse discharge current 10/350 μ s I_{imp} (per mode) ⁽²⁾	25 kA	12.5 kA
Let-through voltage U_p at $I_{imp}^{(1)}$	< 2.0 kV	
Type 2 (BS EN/EN), Class II (IEC)		
Nominal discharge current 8/20 μ s (per mode) I_n	40 kA	20 kA
Let-through voltage U_p at $I_n^{(1)}$	< 2.5 kV	
Maximum discharge current I_{max} (per mode) ⁽²⁾	80 kA	40 kA
Mechanical specification	ESP 690/25/WT	ESP 690/12.5/WT
Temperature range	-40 to +80 °C	
Connection type	Screw terminal	
Conductor size (stranded)	25 mm ²	
Earth connection	Screw terminal	
Volt free contact	Connect via screw terminal with conductor up to 1.5 mm ² (stranded)	
Degree of protection (IEC 60529)	IP20	
Case Material	FR Polymer UL-94 V-0	
Mounting	Indoor, 35 mm top hat DIN rail	
Weight: – Unit	0.5 kg	0.33 kg
– Packaged	0.6 kg	0.43 kg
Dimensions to DIN 43880 – Per module	90 mm x 68 mm x 72 mm (4TE)	90 mm x 68 mm x 216 mm (total: 3 x ESP 690/25/WT)
– HxDxW: ⁽³⁾	– for 3ph TN-C supplies 90 mm x 68 mm x 216 mm (total: 3 x ESP 690/25/WT)	90 mm x 68 mm x 162 mm (total: 3 x ESP 690/12.5/WT)
	– for 3ph TN-S supplies 90 mm x 68 mm x 288 mm (total: 4 x ESP 690/25/WT)	90 mm x 68 mm x 216 mm (total: 4 x ESP 690/12.5/WT)

⁽¹⁾ The maximum transient voltage let-through of the protector throughout the test, per mode

⁽²⁾ The electrical system, external to the unit, may constrain the actual current rating achieved in a particular installation

⁽³⁾ The remote signal contact (removable) adds 10 mm to height

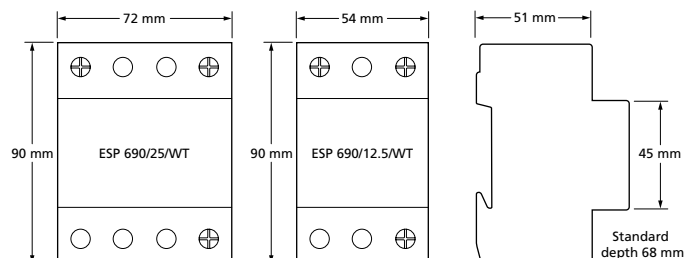

Specific systems protection

ESP PV Series

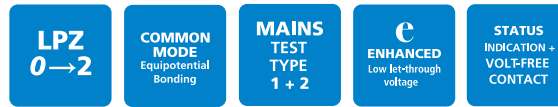

Combined Type 1 and 2 tested protector (to BS EN 61643) for a Photovoltaic PV solar panel system that is on a building where a structural Lightning Protection System (LPS) is employed, for equipotential bonding. For use at boundaries up to LPZ 0 to protect against flashover (on the DC side of the DC-AC inverter) through to LPZ 2 to protect the PV system from damage.

Features & benefits

- Enhanced protection (to IEC/BS EN 62305) offering low let-through voltage further minimizing the risk of flashover creating dangerous sparking or electric shock
- Repeated protection in lightning intense environments
- The varistor based design eliminates the high follow current (If) associated with spark gap based surge protection
- Compact, space saving design
- Indicator shows when the protector requires replacement
- Remote signal contact can indicate the protector's status through interfacing with a building management system

Application

Use on the DC side of the DC-AC inverter for protection against partial direct or indirect lightning strikes. ESP Type 1 AC mains protectors (e.g. ESP 415/III/TNS) are further required at the AC side of the DC-AC inverter.

Installation

Protector should be installed in the main distribution board with connecting leads of minimal length. The protector should be fused and is suitable for attachment to a 35 mm top hat DIN rail. Install in parallel to the DC supply of the DC-AC inverter via fuses.

Accessories

WBX D4

Weatherproof enclosure

Full product range order codes can be found on pages 17/8-17/9

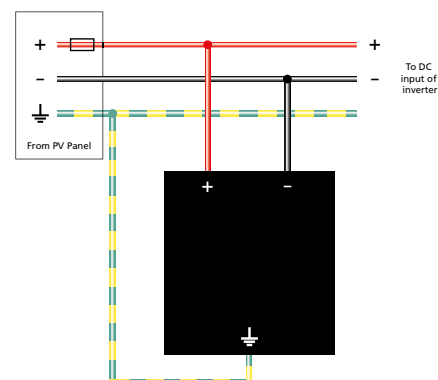

IMPORTANT: The primary purpose of lightning current or equipotential bonding mains Type 1 Surge Protective Devices (SPDs) is to prevent dangerous sparking caused by flashover to protect against the loss of human life. In order to protect electronic equipment and ensure the continual operation of systems, transient overvoltage mains Type 2 and 3 SPDs such as the ESP IM1 or ESP D1 Series are further required, typically installed at downstream sub-distribution boards feeding sensitive equipment. IEC/BS EN 62305 refers to the correct application of mains Type 1, 2 and 3 SPDs as a coordinated set. For further information, please refer to the Furse Guide to BS EN 62305 Protection against Lightning.

Specific systems protection

ESP PV Series

ESP PV Series - Technical specification

Electrical specification	ESP DC550/12.5/PV	ESP DC1000/12.5/PV
ABB order code	7TCA085460R0147	7TCA085460R0146
Maximum DC voltage (RMS/DC)	550 V	1000 V
Short circuit withstand capability	25 kA/50 Hz	
Leakage current (to earth)	< 2.5 mA	
Volt free contact:	Screw terminal	
– current rating	0.5 A	
– nominal voltage (RMS)	250 V	
Back up fuse	Fuses specifically designed for use on PV systems are recommended. Determine the most appropriate back up fuse from assessment of the nominal current of the PV module, and the open circuit voltage of the PV array: <ul style="list-style-type: none"> – Multiply the nominal current of the photovoltaic module by a factor of 1.4 and select the closest, higher value fuse to the calculated figure. – Multiply the open circuit voltage of the PV array by a factor of 1.2 and ensure that the selected fuse has a higher voltage withstand than the calculated figure. 	
Transient specification	ESP DC550/12.5/PV	ESP DC1000/12.5/PV
Type 1 (BS EN/EN), Class I (IEC)		
Nominal discharge current 8/20 μ s (per mode) I_n	20 kA	
Let-through voltage U_p at $I_n^{(1)}$	< 2.0 kV	< 2.6 kV
Impulse discharge current 10/350 μ s I_{imp} (per mode) ⁽²⁾	12.5 kA	
Let-through voltage U_p at $I_{imp}^{(1)}$	< 1.7 kV	< 2.4 kV
Type 2 (BS EN/EN), Class II (IEC)		
Nominal discharge current 8/20 μ s (per mode) I_n	20 kA	
Let-through voltage U_p at $I_n^{(1)}$	< 2.0 kV	< 2.6 kV
Maximum discharge current I_{max} (per mode) ⁽²⁾	40 kA	
Mechanical specification	ESP DC550/12.5/PV	ESP DC1000/12.5/PV
Temperature range	-40 to +80 °C	
Connection type	Screw terminal	
Conductor size (stranded)	25 mm ²	
Earth connection	Screw terminal	
Volt free contact	Connect via screw terminal with conductor up to 1.5 mm ² (stranded)	
Degree of protection (IEC 60529)	IP20	
Case Material	FR Polymer UL-94 V-0	
Mounting	Indoor, 35 mm top hat DIN rail	
Weight: – Unit	0.38 kg	0.59 kg
– Packaged	0.48 kg	0.69 kg
Dimensions to DIN 43880 - HxDxW: ⁽³⁾	90 mm x 68 mm x 72 mm (4TE)	

⁽¹⁾ The maximum transient voltage let-through of the protector throughout the test, per mode

⁽²⁾ The electrical system, external to the unit, may constrain the actual current rating achieved in a particular installation

⁽³⁾ The remote signal contact (removable) adds 10 mm to height

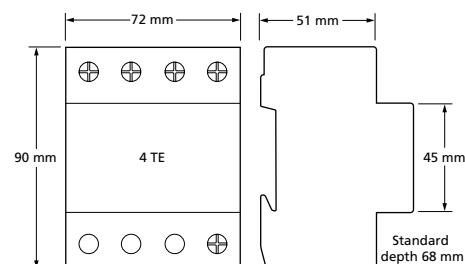

Specific systems protection

ESP SSI Series



Combined Category C, B tested data link protector and Combined Type 2 and Type 3 tested mains protector (to BS EN 61643) suitable for Solid State Interlocking (SSI) mains power and data links. Protectors are Network Rail approved. For use on lines running within buildings at boundaries up to LPZ 1 through to LPZ 3 to protect sensitive electronic equipment.

Features & benefits

- Accepted for use on Network Rail infrastructure. NRS PADS references: ESP SSI/M - 086/047066; ESP SSI/B - 086/047067; ESP SSI/120AC - 086/047058 and ESP SSI/140AC - 086/047059 (Network Rail Approval PA05/00471)
- Very low let-through voltage (enhanced protection to IEC/BS EN 62305) between all sets of conductors - Full Mode protection (ESP SSI/120AC and ESP SSI/140AC) and all signal lines (ESP SSI/M)
- ESP SSI/B (or ESP SSI/B/G) modified base can be permanently wired into the system
- ESP SSI/M plug-in protection module can be replaced without interfering with the operation of the system
- ESP SSI/B (or ESP SSI/B/G) incorporates a 100 Ω terminating resistance that can be connected if required
- ESP SSI/B (or ESP SSI/B/G) can be flat mounted, or a built-in DIN rail foot allows simple clip-on mounting to top-hat (ESP SSI/B) or G DIN rails (ESP SSI/B/G)
- ESP SSI/120AC and ESP SSI/140AC are a compact size for easy installation in trackside cabinets and control rooms
- ESP SSI/120AC and ESP SSI/140AC have three way visual indication of protector status and advanced pre-failure warning

Application

To prevent transient overvoltage damage to Solid State Interlocking (SSI) systems, protectors should be fitted in trackside cabinets and equipment rooms, on both the data link and the mains power lines.

- For single phase mains power supplies of 90-150 Volts, use the ESP SSI/120AC (formerly ESP 120X)
- For single phase mains power supplies of 90-165 Volts, use the ESP SSI/140AC (formerly S065)
- For SSI data links, use the ESP SSI/B (or ESP SSI/B/G) base unit with the ESP SSI/M protection module

Installation

ESP SSI/B: Connect in series with the data link either near where it enters the trackside location cabinet or the equipment room.

ESP SSI/120AC and ESP SSI/140AC: Install in parallel, within the trackside cabinet or equipment room. The protector should be installed on the load side of the fuses, at the secondary side of the step-down transformer. Connect, with very short leads, to phase (BX), neutral (NX or CNX) and earth.

Full product range order codes can be found on pages 17/8-17/9

Use ESP PTE002 SSI tester for line-side testing of SSI/M modules.

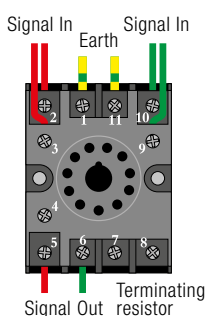

- 1 - Earth in Line
- 2 - Primary signal in + Line
- 3 - Secondary signal in + Line
- 4 - Not connected
- 5 - Signal out + (to DLM) Clean
- 6 - Signal out - (to DLM) Clean
- 7 - Not connected
- 8 - 100 Ω terminating Clean resistor
- 9 - Primary signal in - Line
- 10 - Secondary signal in - Line
- 11 - Earth in Line

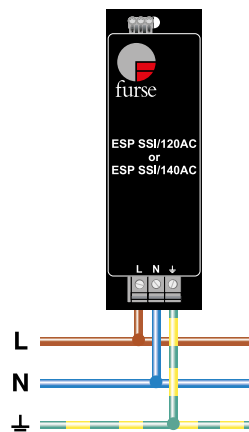

Parallel connection of single phase protectors ESP SSI/120AC and ESP SSI/140AC (fuses not shown for clarity)

Specific systems protection

ESP SSI Series

ESP SSI Series - Technical specification

Electrical specification	ESP SSI/M	ESP SSI/B	Electrical specification	ESP SSI/120AC	ESP SSI/140AC
ABB order code	7TCA085400R0168; 7TCA085400R0166		ABB order code	7TCA085460R0059	7TCA085460R0060
Maximum signal voltage ⁽¹⁾	7 V		Nominal voltage - Phase - Neutral U_0 (RMS)	120 V	140 V
Maximum common mode stand-off voltage	90 Vrms		Maximum working voltage - Phase - Neutral U_c (RMS)	150 V	165 V
Current rating	100 mA	10 A, 250 V	Working voltage (RMS)	90-150 V	90-165 V
In-line resistance (per line, $\pm 10\%$)	4.5 Ω		Frequency range	47-63 Hz	
Leakage: - (Line to line impedance)	> 1 M Ω		Current rating (supply) - see installation instructions	100 A	
- (Line to earth impedance)	> 10 k Ω		Leakage current (to earth)	< 60 μ A	
Differential bandwidth (50 Ω system)	10 MHz		Indicator circuit current	< 10 mA	
ESP SSI/B: This is a modified 11 pin 'relay type' socket containing a 100 Ω $\pm 5\%$ wire-wound 2.5 W resistor connected between terminals 8 and 9. Internal links between terminals 2 & 3, 9 & 10, and 1 & 11.			Volt free contact: ⁽⁴⁾	Screw terminal	
			- Current rating	> 1 M Ω	
			- Nominal voltage (RMS)	> 10 kV	
Transient specification	ESP SSI/M	ESP SSI/B	Transient specification	ESP SSI/120AC	ESP SSI/140AC
Transverse (Differential) 'let-through' voltage ⁽²⁾ U_p	15 V		Let-through voltage (all conductors) Type 2 (BS EN/EN), Class II (IEC)		
Common mode 'let-through' voltage ⁽³⁾ U_p	250 V		Nominal discharge current 8/20 μ s (per mode) I_n	5 kA	
			Let-through voltage U_p at I_n ⁽⁵⁾	460 V	540 V
			Maximum discharge current I_{max} (per mode) ⁽⁶⁾	20 kA	
			Type 3 (BS EN/EN), Class III (IEC)		
			Let-through voltage at U_{oc} of 6 kV 1.2/50 μ s and I_{sc} of 3 kA 8/20 μ s (per mode) ⁽⁷⁾	400 V	500 V
Mechanical specification	ESP SSI/M	ESP SSI/B	Mechanical specification	ESP SSI/120AC	ESP SSI/140AC
Temperature range	-40 to +80 $^{\circ}$ C		Temperature range	-40 to +80 $^{\circ}$ C	
Connection type	-	Screw terminal	Connection type	Screw terminal	
Fixing connection:		2 x M4 fixing holes with 33 mm centres	Conductor size (stranded)	16 mm ²	
- Flat mount	-		Earth connection	Screw terminal	
- Top Hat Din rail mount (ESP SSI/B)	-	An integral clip	Volt free contact	Connect via screw terminal with conductor up to 2.5 mm ² (stranded)	
- G Din rail mount (ESP SSI/B/G)	-	2 x mounting clips with screws	Case material	Steel	
Case material	FR Polymer UL-94 V-0		Weight: - Unit	0.5 kg	
Weight: - Unit	0.065 kg	0.075 kg	- Packaged	0.6 kg	
- Packaged (per 50)	3.25 kg	3.9 kg	Dimensions	See diagram below	
Dimensions	See diagram below				

⁽¹⁾ Maximum signal voltage (DC or AC peak) measured at 200 μ A

⁽²⁾ 'Let-through' voltage is the maximum transient voltage 'let-through' to the equipment to be protected.

C2 test (to BS EN/EN/IEC 61643-21) 2 kV 1.2/50 μ s.

1 kA 8/20 μ s. 'Let-through' voltage ($\pm 10\%$)

⁽³⁾ 'Let-through' voltage is the maximum transient voltage 'let-through' to the equipment to be protected.

C2 test (to BS EN/EN/IEC 61643-21) 4 kV 1.2/50 μ s.

2 kA 8/20 μ s. 'Let-through' voltage ($\pm 20\%$)

⁽⁴⁾ Minimum permissible load is 5 V DC, 10 mA to ensure reliable contact operation

⁽⁵⁾ The maximum transient voltage let-through of the protector throughout the test ($\pm 10\%$), per mode

⁽⁶⁾ The electrical system, external to the unit, may constrain the actual current rating achieved in a particular installation

⁽⁷⁾ Combination wave test within IEEE C62.41-2002 Location Cats C1 & B3, SS CP 33:1996 App. F, AS 1768-1991 App. B, Cat B, UL1449 mains wire-in

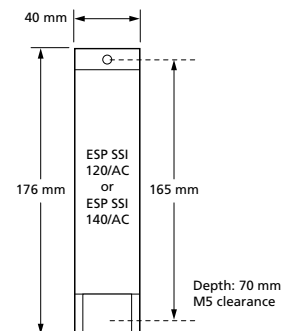
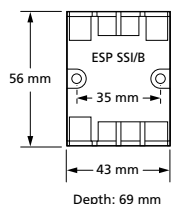
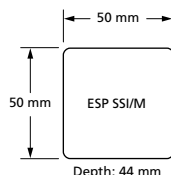

Specific systems protection

ESP TV Series

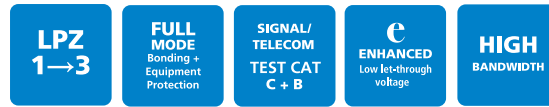

Combined Category C, B tested protector (to BS EN 61643) suitable to protect Cable, Terrestrial and Satellite TV systems. For use on lines running within buildings at boundaries up to LPZ 1 to through to LPZ 3 to protect sensitive electronic equipment.

Features & benefits

- Very low let-through voltage (enhanced protection to IEC/BS EN 62305) between all lines - Full Mode protection
- Low attenuation and high return loss over a wide range of frequencies ensures the protectors do not impair system performance
- Substantial earth termination
- Supplied ready for flat mounting
- Strong metal housing

Application

Use to protect analogue and digital Cable, Terrestrial and Satellite TV installations. ESP CATV/F, ESP MATV/F, ESP SMATV/F and ESP TV/F are suitable for systems using F connectors. ESP TV/EURO is suitable for systems using EURO-TV connectors.

- For protecting terrestrial antenna feeds use ESP TV/F or ESP TV/EURO
- For protecting satellite feeds use ESP SMATV/F

- For protecting distributed combined TV feeds use ESP MATV/F
- For protecting cable TV feeds use ESP CATV/F

For further information on TV applications, see separate Application Note AN006 (contact us for a copy).

Installation

Connect in series with the coaxial cable either near where it enters or leaves each building or close to equipment being protected.

Full product range order codes can be found on pages 17/8-17/9



NOTE: Protectors for coaxial (or twisted pair) CCTV Lines are available. For coaxial RF lines, use the ESP RF Series. Transients can also be conducted into TV systems via the mains power supplies - use suitable ESP mains protection.

Specific systems protection

ESP TV Series

ESP TV Series - Technical specification

Electrical specification	ESP CATV/F	ESP MATV/F	ESP SMATV/F	ESP TV/F	ESP TV/EURO
ABB order code	7TCA085400R0122	7TCA085450R0000	7TCA085450R0026	7TCA085450R0028	7TCA085450R0027
Maximum working voltage ⁽¹⁾	140 V	18.9 V	18.9 V	6.4 V	6.4 V
Maximum operating current	4 A	800 mA	800 mA	300 mA	300 mA
Characteristic impedance	75 Ω				
Bandwidth	5-860 MHz	5-2450 MHz	860-2450 MHz	5-860 MHz	5-860 MHz
Insertion loss:					
– 5-860 MHz	< 0.5 dB	< 0.3 dB	–	< 0.3 dB	< 0.3 dB
– 860-2150 MHz	–	< 1.5 dB	< 1.5 dB	–	–
– 2150-2450 MHz	–	< 2.2 dB	< 2.2 dB	–	–
Return loss (VSWR):					
– 5-860 MHz	> 20 dB (< 1.2:1)	> 32 dB (< 1.05:1)	–	> 32 dB (< 1.05:1)	> 32 dB (< 1.05:1)
– 860-2150 MHz	–	> 20 dB (< 1.2:1)	> 20 dB (< 1.2:1)	–	–
– 2150-2450 MHz	–	< 2.2 dB	< 2.2 dB	–	–
Transient specification	ESP CATV/F	ESP MATV/F	ESP SMATV/F	ESP TV/F	ESP TV/EURO
Let-through voltage (all conductors)⁽²⁾ Up					
C2 test 4 kV 1.2/50 μs, 2 kA 8/20 μs to BS EN/EN/IEC 61643-21	270 V	70 V	70 V	65 V	65 V
C1 test 1 kV 1.2/50 μs, 0.5 kA 8/20 μs to BS EN/EN/IEC 61643-21	265 V	60 V	60 V	50 V	50 V
B2 test 4 kV 10/700 μs to BS EN/EN/IEC 61643-21	245 V	45 V	45 V	30 V	30 V
5 kV, 10/700 μs ⁽³⁾	250 V	50 V	50 V	35 V	35 V
Maximum surge current					
8/20 μs to ITU-T K.45:2003, IEEE C62.41.2:2002	3 kA				
Mechanical specification	ESP CATV/F	ESP MATV/F	ESP SMATV/F	ESP TV/F	ESP TV/EURO
Temperature range	-40 to +80 °C				-40 to +80 °C
Connection type	F female				Euro-TV
Earth connection	~ 9.5 mm (3/8") diameter earth stud				~ 9.5 mm (3/8") diameter earth stud
Case Material	Diecast				Diecast
Weight: – Unit	0.14 kg				0.14 kg
– Packaged	0.15 kg				0.15 kg
Dimensions	See diagram below				

⁽¹⁾ Maximum working voltage (DC or AC peak) measured at < 5 μA (ESP CATV/F) and < 50 mA (ESP MATV/F, ESP SMATV/F, ESP TV/EURO, ESP TV/F)

⁽²⁾ The maximum transient voltage let-through of the protector throughout the test (±10%), line to line & line to earth. Response time < 10 ns

⁽³⁾ Test to IEC 61000-4-5:2006, ITU-T (formerly CCITT) K.20, K.21 and K.45, Telcordia GR-1089-CORE, Issue 2:2002, ANSI TIA/EIA/IS-968-A:2002 (formerly FCC Part 68)

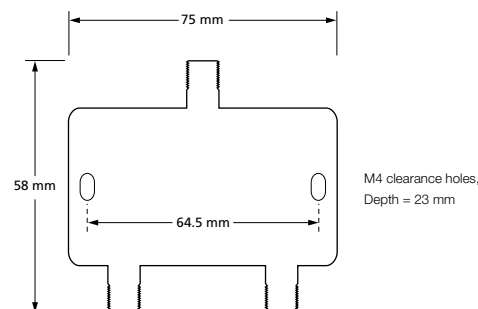

Specific systems protection

ESP CCTV Series

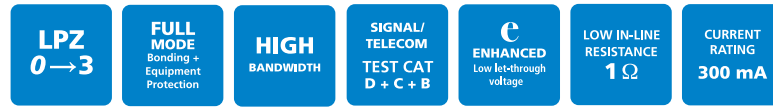

Combined Category D, C, B tested protector (to BS EN 61643) suitable for coaxial CCTV cables with BNC connectors (ESP CCTV/B) or twisted pair CCTV lines (ESP CCTV/T) on systems with either an earthed or an isolated screen. Not suitable for use on broadcast, satellite or cable TV systems. For use at boundaries up to LPZ 0 to protect against flashover (typically the service entrance location) through to LPZ 3 to protect sensitive electronic equipment.

Features & benefits

- Very low let-through voltage (enhanced protection to IEC/BS EN 62305) between all lines - Full Mode protection
- Full Mode design capable of handling partial lightning currents as well as allowing continual operation of protected equipment
- Repeated protection in lightning intense environments
- 100 MHz bandwidth prevents the degradation of high frequency signals
- Low in-line resistance to minimize unnecessary reductions in signal strength and maximizes signalling distance
- Very low reflection coefficient/VSWR ensure that the protector doesn't disrupt system operations
- Suitable for either earthed or isolated screen systems
- Sturdy, conductive ABS housing for 2 way shielding - preventing emissions & providing signals with immunity from external interference
- Convenient holes for flat mounting on base or side
- Built-in DIN rail foot for easy installation on a top hat DIN rail
- ESP CCTV/T has colour coded terminals for a quick and easy installation check - grey for the dirty (line) end and green for the clean end
- Substantial earth stud to enable effective earthing
- Integral earthing plate for enhanced connection to earth via CME kit
- ESP CCTV/B has Network Rail Approval PA05/02510. NRS PADS reference 086/023410

Application

Use these protectors on the video cable to outdoor CCTV cameras and central control and monitoring equipment.

Installation

Connect in series with the CCTV cable in a convenient place close to the equipment being protected. For outdoor CCTV cameras, protectors should be mounted in the junction box, or in a separate enclosure, close to the camera. Protect central control and monitoring equipment inside the building by installing protectors on all incoming or outgoing lines, either: a) near where they enter or leave the building, or b) close to the equipment being protected (or actually within its control panel).

Accessories

When CCTV protectors are installed in groups, or alongside protectors for signal and mains power lines, these can be mounted and earthed simultaneously on a CME kit. A CME 4 will accommodate the video, telemetry and power protectors to a camera. If protectors cannot be incorporated within an existing panel or enclosure, WBX enclosures are available for up to 4, 8, 16 or 32 protectors and their associated CME kit. The WBX 4/GS is a secure IP66 enclosure suitable for a CME 4 and associated protectors.

Full product range order codes can be found on pages 17/8-17/9

Series connection for ESP CCTV/B

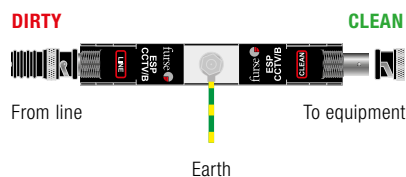

Series connection for ESP CCTV/T

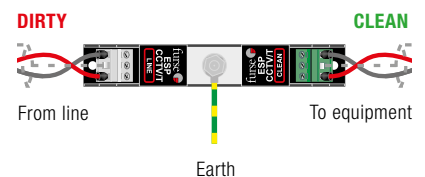

NOTE: Camera telemetry or control lines should be protected with a suitable Lightning Barrier from the ESP D or E Series. Protectors for the power supply to individual cameras (e.g. ESP 240-16A) and the mains supply to the control room (e.g. ESP 240 D1) are available. For coaxial RF (ESP RF Series) cable protectors and CATV systems (ESP CATV/F) are also available.

Specific systems protection

ESP CCTV Series

ESP CCTV Series - Technical specification

Electrical specification	ESP CCTV/B	ESP CCTV/B-15V	ESP CCTV/B-30V	ESP CCTV/B-50V	ESP CCTV/T	ESP CCTV/T-15V	ESP CCTV/T-30V	ESP CCTV/T-50V
ABB order code	7TCA085400R0123	7TCA085400R0124	7TCA085400R0125	7TCA085400R0126	7TCA085400R0129	7TCA085400R0270	7TCA085400R0271	7TCA085400R027
Nominal voltage ⁽¹⁾ (peak-peak)	1 V				2 V			
Maximum working voltage U_c ⁽²⁾ (peak)	7.79 V	16.7 V	36.7 V	56.7 V	7.79 V	16.7 V	36.7 V	56.7 V
Current rating (signal)	300 mA							
In-line resistance ($\pm 10\%$)	1 Ω inserted in coax inner				1 Ω per line			
Bandwidth (-3 dB 75 Ω system) ⁽³⁾	> 100 MHz							
Voltage standing wave ratio	< 1.2:1							
Transient specification	ESP CCTV/B	ESP CCTV/B-15V	ESP CCTV/B-30V	ESP CCTV/B-50V	ESP CCTV/T	ESP CCTV/T-15V	ESP CCTV/T-30V	ESP CCTV/T-50V
Let-through voltage (all conductors)⁽⁴⁾ Up								
C2 test 4 kV 1.2/50 μ s, 2 kA 8/20 μ s to BS EN/EN/IEC 61643-21	39.5 V	55.0 V	78.0 V	105.0 V	39.5 V	55.0 V	78.0 V	105.0 V
C1 test 1 kV 1.2/50 μ s, 0.5 kA 8/20 μ s to BS EN/EN/IEC 61643-21	26.0 V	42.0 V	66.5 V	93.5 V	26.0 V	42.0 V	66.5 V	93.5 V
B2 test 4 kV 10/700 μ s to BS EN/EN/IEC 61643-21	16.0 V	27.2 V	47.5 V	73.6 V	16.0 V	27.2 V	47.5 V	73.6 V
5 kV, 10/700 μ s ⁽⁵⁾	17.0 V	28.2 V	49.5 V	76.2 V	17.0 V	28.2 V	49.5 V	76.2 V
Maximum surge current⁽⁶⁾								
D1 test 10/350 μ s to BS EN/EN/IEC 61643-21: - Per signal wire	2.5 kA				2.5 kA			
- Per pair	-				5 kA			
8/20 μ s to ITU (formerly CCITT): - Per signal wire	10 kA				10 kA			
- Per pair	-				20 kA			
Mechanical specification	ESP CCTV/B variants				ESP CCTV/T variants			
Temperature range	-40 to +80 °C							
Connection type	Coaxial BNC female				Screw terminal			
Conductor size (stranded)	Not applicable				2.5 mm ²			
Earth connection	M6 stud							
Case Material	Conductive ABS UL94 V-0				Conductive ABS UL94 V-0			
Weight: - Unit	0.08 kg							
- Packaged	0.9 kg							
Dimensions	See diagram below							

⁽¹⁾ Nominal voltage (DC or AC peak) measured at <10 μ A leakage

⁽²⁾ Maximum working voltage (DC or AC peak) measured at 5 mA leakage

⁽³⁾ Capacitance < 30 pF

⁽⁴⁾ The maximum transient voltage let-through of the protector throughout the test ($\pm 10\%$), line to line & line to earth. Screen to earth let-through voltage will be up to 600 V (with 5 kV 10/700 test), when protector is configured for use with non-earthed or isolated screen systems. Response time < 10 ns

⁽⁵⁾ Test to IEC 61000-4-5:2006, ITU-T (formerly CCITT) K.20, K.21 and K.45, Telcordia GR-1089-CORE, Issue 2:2002, ANSI TIA/EIA/IS-968-A:2002 (formerly FCC Part 68)

⁽⁶⁾ The installation and connectors external to the protector may limit the capability of the protector

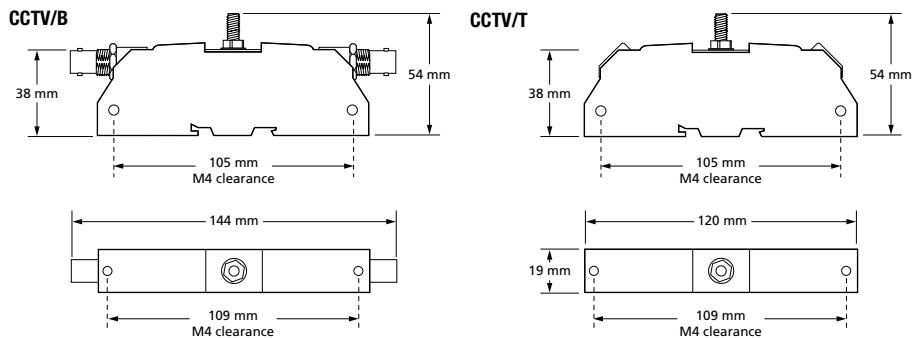

Specific systems protection

ESP RF Series

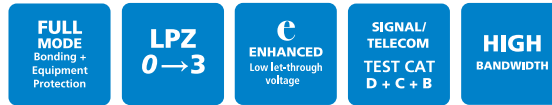

Combined Category D, C, B tested protector (to BS EN 61643) suitable for RF systems using coaxial cables at frequencies between DC and 2.7 GHz and where DC power is present. Suitable for RF systems with power up to 2.3 kW. For use at boundaries up to LPZ 0 to protect against flashover (typically the service entrance location) through to LPZ 3 to protect sensitive electronic equipment.

Features & benefits

- Very low let-through voltage (enhanced protection to IEC/BS EN 62305) between all lines - Full Mode protection
- Full Mode design capable of handling partial lightning currents as well as allowing continual operation of protected equipment
- Repeated protection in lightning intense environments
- Superior transient protection to both Gas Discharge Tube (GDT) and Quarter Wave Stub (QWS) based protectors
- Wide bandwidth means a single product is suitable for a range of applications
- Very low attenuation and near unity VSWR over a wide range of frequencies ensure the protectors do not impair system performance
- Available with N, 7/16 DIN and BNC connectors
- Easily mounted and earthed via fixtures on the base of the unit that accept M3 and M5 screws or via mounting brackets
- Additional mounting plates give increased flexibility
- Robust white bronze plated aluminium housing (silver plate option)

Application

Use on coaxial cables to protect RF transmitter and receiver systems, including electronics located at the antenna or dish. Typical examples include cell sites, military communications, satellite earth stations, pager systems and emergency services communications systems.

Installation

In a building, connect in series with the coaxial cable near where it enters or leaves the structure, or close to the equipment being protected. This should be as close as possible to the system's earth star point (to enable a good connection to earth). On a mast, connect in series with the coaxial cable near the antenna/dish being protected. Install in a radio communications room, an existing cabinet or a suitable enclosure.

Accessories

- ESP RF BK1** Straight mounting plates
- ESP RF BK2** 90° angled mounting plates
- ESP RF BK3** Bulkhead through mounting plate (single)
- ESP RF BK4** Bulkhead through mounting plate (for 4 products)
- ESP RF GDT-x** Replacement gas discharge tubes (Where x is the correct GDT part code digit for your system).

Full product range order codes can be found on pages 17/8-17/9

ESP RF 111A21 with N female connectors installed in series

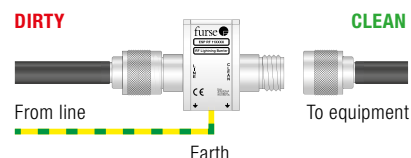

PART NUMBERING SYSTEM: Furse RF protectors have six digit part codes, prefixed with ESP RF. The selected digits define the exact specification of the required protector, e.g. **ESP RF AABCDE**

Connector type - ESP RF AAxxxx The first 2 digits refer to the connector type: **11** - N type female, **AA** - 7/16 DIN type female, **44** - BNC female

Line impedance - ESP RF xxBxxx 3rd digit refers to the line impedance. Currently only one option: **1** - 50 Ω transmission line.

Gas Discharge Tube (GDT) selection - ESP RF xxxCxx Select the 4th digit from the table at the bottom (opposite). Selection of the correct GDT is critical

in the effectiveness of using these protectors. For the correct GDT, take the maximum RF power or voltage of the system and select a GDT with a voltage/power handling greater than the system.

IMPORTANT NOTE: When using the peak RF voltage to select the GDT, if the system is a multi-carrier system the (in phase) peak RF voltage can be calculated as the total of all the single carrier peak voltages on the transmission line.

Protector rating - ESP RF xxxxDx 5th digit specifies the protector rating: **1** - Higher specification, **2** - Standard specification **Case plating - ESP RF xxxxE** 6th digit specifies the case plating: **1** - White bronze, **2** - Silver

NOTE: These protectors are based on a continuous transmission line with a GDT connected between this line and screen/earth, and are suited for applications where DC is required to pass to the equipment. For RF applications where the connected equipment is very sensitive to transient overvoltages, use the higher specification RF protectors. ESP CCTV/B and ESP CCTV/T are suitable for use on coaxial (or twisted pair) CCTV lines. For coaxial CATV lines, use the CATV/F.

Specific systems protection

ESP RF Series

ESP RF Series - Technical specification

Electrical specification	ESP RF xx1x21					
ABB order code	** See table at the bottom of the page for Part no./ABB order code **					
Gas Discharge Tube voltage	90 V	150 V	230 V	350 V	470 V	600 V
Maximum working voltage U_c (RMS) ⁽¹⁾	51 V	85 V	130 V	200 V	265 V	340 V
Characteristic impedance	50 Ω					
Bandwidth	DC-2.7 GHz					
Voltage standing wave ratio	≤ 1.1					
Insertion loss over bandwidth	≤ 0.1 dB					
Maximum power ⁽¹⁾	40 W	120 W	280 W	650 W	1.15 kW	1.90 kW
Transient specification	ESP RF xx1x21					
Let-through voltage (all conductors)⁽²⁾ Up						
C2 test 4 kV 1.2/50 μ s, 2 kA 8/20 μ s to BS EN/EN/IEC 61643-21	< 700 V	< 650 V	< 700 V	< 800 V	< 900 V	< 1050 V
C1 test 1 kV 1.2/50 μ s, 0.5 kA 8/20 μ s to BS EN/EN/IEC 61643-21	< 550 V	< 450 V	< 550 V	< 650 V	< 800 V	< 950 V
B2 test 4 kV 10/700 μ s to BS EN/EN/IEC 61643-21	< 400 V	< 350 V	< 450 V	< 550 V	< 730 V	< 800 V
5 kV, 10/700 μ s ⁽³⁾	< 430 V	< 370 V	< 470 V	< 580 V	< 750 V	< 830 V
Maximum surge current⁽⁴⁾						
D1 test 10/350 μ s to BS EN/EN/IEC 61643-21	2.5 kA					
8/20 μ s to ITU-T K.45:2003, IEEE C62.41.2:2002	20 kA					
Mechanical specification	ESP RF 111x21	ESP RF AA1x21		ESP RF 441x21		
Temperature range	-40 to +80 °C					
Connection type	N female	7/16 DIN female		BNC female		
Conductor size (stranded)	Via mounting fixtures					
Case Material	Aluminium, white bronze plated					
Weight: – Unit	120 g	190 g		90 g		
– Packaged	140 g	210 g		110 g		
Dimensions	See diagram below					

- ⁽¹⁾ The maximum RF working voltage and maximum power for the protectors is dependent on the GDT selected, with the power levels derated based on real life 'worst case' conditions with VSWR=2:1. See 'Gas Discharge Tube selection' below
- ⁽²⁾ The maximum transient voltage let-through of the protector throughout the test ($\pm 10\%$) ($\pm 10\%$). Response time < 10 ns. This let-through voltage represents a deviation from the applied signal voltage, present at the time of the test
- ⁽³⁾ Test to IEC 61000-4-5:2006, ITU-T (formerly CCITT) K.20, K.21 and K.45, Telcordia GR-1089-CORE, Issue 2:2002, ANSI TIA/EIA/IS-968-A:2002 (formerly FCC Part 68)
- ⁽⁴⁾ The installation and connections external to the protector may limit the capability of the protector

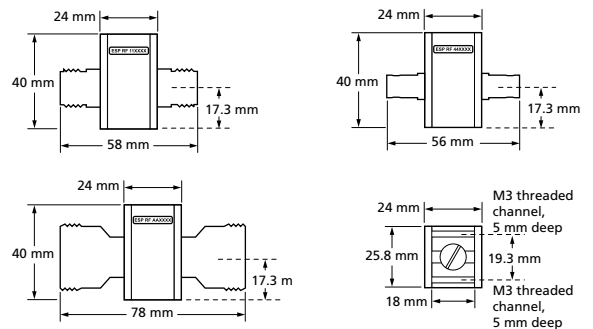

ESP RF BK1 (ABB order code: 7TCA085450R0017)

Straight mounting bracket, 53 x 26.3 x 3 mm
2 x M4 clearance mounting holes, 16.3 mm apart

ESP RF BK2 (ABB order code: 7TCA085450R0018)

90° mounting bracket, 33 x 26.3 x 3 mm, 20 x 26.3 x 3 mm
2 x M4 clearance mounting holes, 16.3 mm apart, 14 mm from fold line

ESP RF BK3 (ABB order code: 7TCA085450R0020)

90° mounting bracket, 50 x 24 x 1.5 mm, 60 x 24 x 1.5 mm
2 x M5 clearance mounting holes, 40 mm apart

ESP RF BK4 (ABB order code: 7TCA085450R0046)

90° quad mounting bracket, 50 x 24 x 1.5 mm, 210 x 24 x 1.5 mm
5 x M5 clearance mounting holes, various spacings

Mounting brackets supplied with screws for fixing to protector

Gas Discharge Tube selection

V_{Peak}	V_{RMS}	Max RF power 50 Ω system (P_{RMS}) with VSWR = 2:1	GDT voltage code	GDT part digit
72 V	51 V	40 W	90 V	1
120 V	85 V	120 W	150 V	2
185 V	130 V	280 W	230 V	3
280 V	200 V	650 W	350 V	4
375 V	265 V	1.15 kW	470 V	5
480 V	340 V	1.90 kW	600 V	6

Power levels have been de-rated to allow for real life 'worst case' conditions, calculated with VSWR as 2:1

Specific systems protection

ESP RF Series

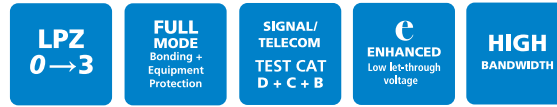

Combined Category D, C, B tested protector (to BS EN 61643) suitable for RF systems (of power up to 150 W) using coaxial cables at frequencies between 50 MHz and 2.7 GHz to provide effective protection without impairing system performance. For use at boundaries up to LPZ 0 to protect against flashover (typically the service entrance location) through to LPZ 3 to protect sensitive electronic equipment.

Features & benefits

- Very low let-through voltage (enhanced protection to IEC/BS EN 62305) between all lines - Full Mode protection
- Full Mode design capable of handling partial lightning currents as well as allowing continual operation of protected equipment
- Repeated protection in lightning intense environments
- Superior transient protection to both Gas Discharge Tube (GDT) and Quarter Wave Stub (QWS) based protectors
- Very low attenuation and near unity VSWR over a wide range of frequencies ensure the protectors do not impair system performance
- Wide bandwidth means a single product is suitable for a range of applications
- Available with N, 7/16 DIN and BNC connectors
- Easily mounted and earthed via fixtures on the base of the unit that accept M3 and M5 screws or via mounting brackets
- Additional mounting plates give increased flexibility
- Robust white bronze plated aluminium housing (silver plate option)

Application

Use on coaxial cables to protect RF transmitter and receiver systems, including electronics located at the antenna or dish. Typical examples include cell sites, military communications, satellite earth stations, pager systems and emergency services communications systems.

Installation

In a building, connect in series with the coaxial cable near where it enters or leaves the structure, or close to the equipment being protected. This should be as close as possible to the system's earth star point (to enable a good connection to earth). On a mast, connect in series with the coaxial cable near the antenna/dish being protected. Install in a radio communications room, an existing cabinet or a suitable enclosure.

Accessories

ESP RF BK1

Straight mounting plates

ESP RF BK2

90° angled mounting plates

ESP RF BK3

Bulkhead through mounting plate (single)

ESP RF BK4

Bulkhead through mounting plate (for 4 products)

ESP RF GDT-A

Replacement gas discharge tube

Full product range order codes can be found on pages 17/8-17/9

ESP RF 111A11 with N female connectors installed in series

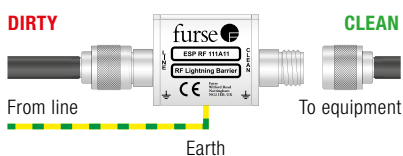

ESP RF 441A11 with BNC female connectors installed in series

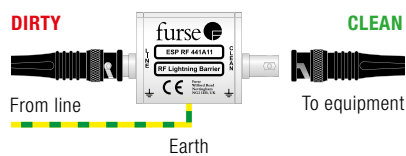

ESP RF AA1A11 with 7/16 DIN female connectors installed in series

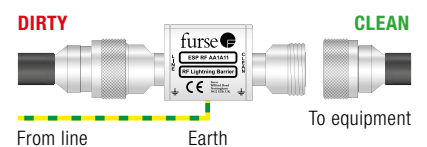

NOTE: The high level of protection offered by these units comes from the addition of a high pass filter circuit which gives a very low letthrough voltage. It should be noted that due to this high pass filter circuit no DC power can pass along the transmission line. This is referred to as "DC blocked". Protectors with other connectors are available. For RF applications where DC power is present on the coaxial cable, use the alternative RF protectors. The ESP CCTV/B and ESP CCTV/T are suitable for use on coaxial (or twisted pair) CCTV lines. For coaxial CATV lines, use the ESP CATV/F.

Specific systems protection

ESP RF Series

ESP RF Series - Technical specification

Electrical specification	ESP RF 111A11	ESP RF AA1A11	ESP RF 441A11
ABB order code	7TCA085450R0007	7TCA085450R0016	7TCA085450R0014
Maximum working voltage U_c (RMS)	86 V		
Maximum transmitted power (RMS)	150 W		
Characteristic impedance	50 Ω		
Bandwidth	50-2700 MHz		
Voltage standing wave ratio	≤ 1.2		
Insertion loss over bandwidth:			
- 50-500 MHz	≤ 0.4 dB		
- 500-1,600 MHz	≤ 0.2 dB		
- 1.6-2.7 GHz	≤ 0.4 dB		
Maximum power	150 W		
Transient specification	ESP RF 111A11	ESP RF AA1A11	ESP RF 441A11
Let-through voltage (all conductors)⁽¹⁾ Up			
C2 test 4 kV 1.2/50 μ s, 2 kA 8/20 μ s to BS EN/EN/IEC 61643-21	24 V		
C1 test 1 kV 1.2/50 μ s, 0.5 kA 8/20 μ s to BS EN/EN/IEC 61643-21	15 V		
B2 test 4 kV 10/700 μ s to BS EN/EN/IEC 61643-21	15 V		
5 kV, 10/700 μ s ⁽²⁾	20 V		
Maximum surge current⁽³⁾			
D1 test 10/350 μ s to BS EN/EN/IEC 61643-21	1 kA		
8/20 μ s to ITU-T K.45:2003, IEEE C62.41.2:2002	10 kA		
Mechanical specification	ESP RF 111A11	ESP RF AA1A11	ESP RF 441A11
Temperature range	-40 to +80 °C		
Connection type	N female	7/16 DIN female	BNC female
Conductor size (stranded)	Via mounting fixtures		
Case Material	Aluminium, white bronze plated		
Weight:			
- Unit	150 g	220 g	120 g
- Packaged	170 g	240 g	160 g
Dimensions	See diagram below		

⁽¹⁾ The maximum transient voltage let-through of the protector throughout the test ($\pm 10\%$). Response time < 10 ns. This let-through voltage represents a deviation from the applied signal voltage, present at the time of the test

⁽²⁾ Test to IEC 61000-4-5:2006, ITU-T (formerly CCITT) K.20, K.21 and K.45, Telcordia GR-1089-CORE, Issue 2:2002, ANSI TIA/EIA/IS-968-A:2002 (formerly FCC Part 68)

⁽³⁾ The installation and connectors external to the protector may limit the capability of the protector

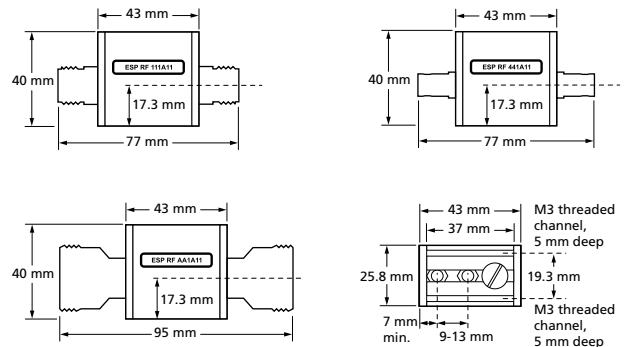

ESP RF BK1 (ABB order code: 7TCA085450R0017)

Straight mounting bracket, 53 x 26.3 x 3 mm
2 x M4 clearance mounting holes, 16.3 mm apart

ESP RF BK2 (ABB order code: 7TCA085450R0018)

90° mounting bracket, 33 x 26.3 x 3 mm, 20 x 26.3 x 3 mm
2 x M4 clearance mounting holes, 16.3 mm apart, 14 mm from fold line

ESP RF BK3 (ABB order code: 7TCA085450R0020)

90° mounting bracket, 50 x 24 x 1.5 mm, 60 x 24 x 1.5 mm
2 x M5 clearance mounting holes, 40 mm apart

ESP RF BK4 (ABB order code: 7TCA085450R0046)

90° quad mounting bracket, 50 x 24 x 1.5 mm, 210 x 24 x 1.5 mm
5 x M5 clearance mounting holes, various spacings

Mounting brackets supplied with screws for fixing to protector



Electronic systems protection

Protector accessories

Protector accessories

WBX Series	15/2
CME Series	15/3
ESP Remote display unit	15/4
Cable assembly	15/4
Slim Line replacement base/module	15/5
Connecting and earthing bar	15/5
ESP PTE002	15/5
ESP RF mounting plates	15/5
ESP RF GDT-x	16/18

Protector accessories

WBX Series



WBX Series

A range of moisture and dirt resistant enclosures for the convenient installation of ESP protectors and their associated CME with grey base and either a see-through or grey (part number /G or /GS) lid.

Features & benefits

- Tough polycarbonate enclosures (except ABS WBX 2/G)
- Weatherproof with IP resistance to dirt and water of IP56 or more
- Clear lid enables easy visual inspection of the protector's visual status indication (WBX 3, WBX 4, WBX D4, WBX 8, WBX D8, WBX M2, WBX M4)
- Grey lid for applications not needing regular protector inspection (WBX 2/G, WBX 3/G, WBX 4/GS, WBX 8/GS and WBX 16/2/G)
- For external CCTV and other installations requiring added security the WBX 4/GS and WBX 8/GS are supplied with an opaque lid and special secure head screws (plus tool)
- Supplied complete with metal base (mounting) plate with pre-prepared mounting positions and fixing hardware for easy installation (except WBX 2/G which has a plain metal base)

Application

Use on coaxial cables to protect RF transmitter and receiver systems, including electronics located at the antenna or dish. Typical examples include cell sites, military communications, satellite earth stations, pager systems and emergency services communications systems.

Full product range order codes can be found on pages 17/8-17/9

Installation

WBX Series

The protector(s), or CME kit, are mounted on the metal base plate, which in turn mounts in the enclosure.

WBX Series - Technical specification

Enclosure part no.	For use with following protectors	Enclosure part no.	For use with following protectors
WBX D4	1 ESP 240 or 415/XXX/TNS or TNC protector, or single phase D1 series protector	WBX M4	1 ESP M4 series protector
WBX D8	1 ESP 415/XXX/TT protector, or three phase D1 series protector	WBX 4 or the secure WBX 4/GS	1 CME 4 and associated protectors
WBX 3	1 single phase M1 series protector	WBX 8 or the secure WBX 8/GS	1 CME 8 and associated protectors
WBX 4	1 three phase M1 series protector	WBX 16/2/G	1 or 2 CME 16 and associated protectors
WBX M2	1 ESP M2 series protector	WBX 2/G	1 or 2 single earth stud protectors
		WBX 3/G	Up to 3 single earth stud protectors
		WBX 3/G	1 double earth stud protector

	WBX 2/G	WBX 3 WBX 3/G	WBX 4 WBX 4/GS	WBX D4	WBX 8 WBX 8/GS	WBX D8	WBX 16/2/G	WBX M2	WBX M4	WBX SLQ WBX SLQ/G
Weight: - Unit	0.45 kg	0.5 kg	0.9 kg	0.4 kg	1.3 kg	0.55 kg	6.4 kg	1.9 kg	2.2 kg	0.7 kg
- Packaged	0.5 kg	0.55 kg	0.95 kg	0.45 kg	1.35kg	0.6 kg	7.6 kg	2.3 kg	3.0 kg	1.0 kg

Dimensions:

Length: - Internal	150 mm	222 mm	246 mm	-	225 mm	-	460 mm	254 mm	246 mm	230 mm
- External	160 mm	230 mm	255 mm	200 mm	235 mm	200 mm	474 mm	280 mm	255 mm	250 mm
Width: - Internal	110 mm	72 mm	171 mm	-	225 mm	-	380 mm	254 mm	171 mm	105 mm
- External	120 mm	80 mm	180 mm	123 mm	235 mm	195 mm	396 mm	280 mm	180 mm	125 mm
Depth: - Internal	71 mm	79 mm	119 mm	-	100 mm	-	120 mm	115 mm	119 mm	110 mm
- External	90 mm	85 mm	125 mm	112 mm	117 mm	112 mm	128 mm	130 mm	125 mm	125 mm
Fixing centres (mm)	148 x 90	210 x 60	240 x 165	140 centrally	215 x 215	140 x 88	380 x 310	254 x 254	240 x 165	235 x 110
IP rating	IP66	IP67	IP66	IP65	IP66	IP65	IP56	IP67	IP67	IP67
Temperature range	-40 to +80 °C	-40 to +80 °C	-15 to +75 °C	-5 to +40 °C	-15 to +75 °C	-5 to +40 °C	-25 to +60 °C	-40 to +80 °C	-40 to +80 °C	-40 to +80 °C
Flammability	UL 746C 5V	UL 746C 5V	UL 94 V2	UL 94 V2	UL 94 V2	UL 94 V2	UL 94 V0	UL 746C 5V	UL 746C 5V	UL 746C 5V

Protector accessories

CME Series



CME Series

CME Series

Enables groups of protectors to be simultaneously mounted and earthed via their earth stud. Suitable for installing protectors with one or two earth studs on their top face. Available with 4, 8, 16 and 32 mounting holes.

Features & benefits

- Enables quick and easy installation of protectors for added convenience
- Speedy installation of groups of protectors saves time and money
- Individual protectors can be changed without needing to remove others
- Sturdy construction
- Supplied with a choice of flat and round ended fixing screws to suit your application

Application

Use CME kits to simultaneously mount and earth groups of single and double earth stud protectors. Each single earth stud protector requires one CME mounting position and each double earth stud protector requires two CME mounting positions, this includes:

- High conductivity copper with electro-tin plating and nylon insulating pillars, for low impedance to earth

Single earth stud protectors which are:

- | | | | |
|------------|------------|------------|--------------|
| - ESP 06D | - ESP 06E | - ESP 06H | - ESP TN |
| - ESP 15D | - ESP 15E | - ESP 15H | - ESP RTD |
| - ESP 30D | - ESP 30E | - ESP 30H | - ESP CCTV/B |
| - ESP 50D | - ESP 50E | - ESP 50H | - ESP CCTV/T |
| - ESP 110D | - ESP 110E | - ESP 110H | - ESP RS485 |

Double earth stud protectors which are:

- | | | |
|--------------|---------------|---------------|
| - ESP 120-5A | - ESP 120-16A | - ESP 240-16A |
| - ESP 240-5A | - ESP 277-5A | - ESP 277-16A |

Once you know how many CME mounting positions you require choose a CME kit to suit:

- CME 4 has 4 mounting positions
- CME 8 has 8 mounting positions
- CME 16 has 16 mounting positions
- CME 32 has 32 mounting positions

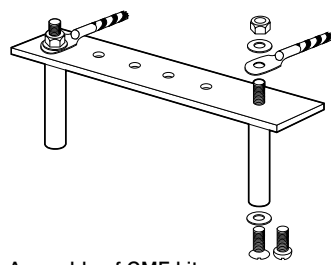

Assembly of CME kit
Earth connection (not supplied)

Accessories

Enclosures suitable for a CME 4 and its associated protectors:

(WBX 4/GS), CME 8 and protectors **(WBX 8/GS)** or one or two **CME 16** and protectors **(WBX 16/2/G)**

Full product range order codes can be found on pages 17/8-17/9

Installation

The earth bar is supported by a series of mounting pillars (which are fixed to the cubicle or box base). Protectors are attached to the CME's earth bar via their earth stud(s) and earthed with shared connections to earth. We suggest one earth connection per mounting pillar.

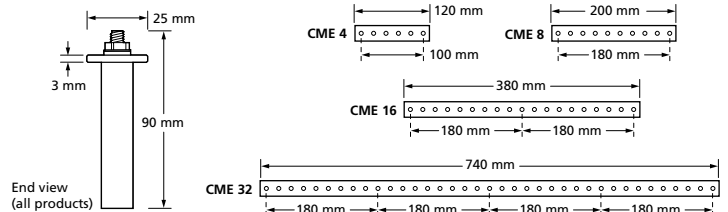

CME Series - Technical specification

	CME 4	CME 8	CME 16	CME 32
Hole size	6.5 mm with 20 mm spacings			
Weight	0.1 kg	0.15 kg	0.3 kg	0.6 kg
Dimensions	See diagram opposite			

Protector accessories

Accessories



ESP Remote display unit

Use with: ESP M1R, M2R and M4R

Part no.	Description
ESP RDU/415M1R	Remote LED display for 3 phase 415 V M1R protector
ESP RDU/415M2R	Remote LED display for 3 phase 415 V M2R protector
ESP RDU/415M4R	Remote LED display for 3 phase 415 V M4R protector
ESP RDU/480M1R	Remote LED display for 3 phase 480 V M1R protector
ESP RDU/480M2R	Remote LED display for 3 phase 480 V M2R protector
ESP RDU/480M4R	Remote LED display for 3 phase 480 V M4R protector
ESP RDU-SEAL	IP64 rated seal for remote displays

Full product range order codes can be found on pages 17/8-17/9



Cable assembly

Use to: Connect display units to suitable three phase protectors

Part no.	Description	Length
ESP RLA-1	Cable assembly for connecting ESP Remote Display Unit to ESP M1R, M2R and M4R series	1 m
ESP RLA-2	Cable assembly for connecting ESP Remote Display Unit to ESP M1R, M2R and M4R series	2 m
ESP RLA-4	Cable assembly for connecting ESP Remote Display Unit to ESP M1R, M2R and M4R series	4 m
ESP RLA HD-1	Cable assembly for connecting display unit to three phase ESP XXX D1R or ESP XXX D1R/LCD protectors	1 m
ESP RLA HD-2	Cable assembly for connecting display unit to three phase ESP XXX D1R or ESP XXX D1R/LCD protectors	2 m
ESP RLA HD-4	Cable assembly for connecting display unit to three phase ESP XXX D1R or ESP XXX D1R/LCD protectors	4 m

Full product range order codes can be found on pages 17/8-17/9



ESP Remote display unit

Use with: ESP D1R variants

Part no.	Description
ESP RDU D1R/208	Remote LED display for 3 phase 208 V D1R protector
ESP RDU D1R/415	Remote LED display for 3 phase 415 V D1R protector
ESP RDU D1R/480	Remote LED display for 3 phase 480 V D1R protector
ESP RDU D1R/LCD/208	Remote LCD display for 3 phase 208 V D1R protector
ESP RDU D1R/LCD/415	Remote LCD display for 3 phase 415 V D1R protector
ESP RDU D1R/LCD/480	Remote LCD display for 3 phase 480 V D1R protector

Full product range order codes can be found on pages 17/8-17/9



Cable assembly

Use with: ESP ISDN/RJ45-* /8 or ESP Cat-5e or ESP Cat-6 protector range

Part no.	Description	Length
ESP CAT5e/UTP-1	Cable assembly for ESP Cat-5e with unshielded RJ45 connections	1 m
ESP CAT6/STP-2	Cable assembly for ESP Cat-6 with shielded RJ45 connections	2 m

Cable assembly with RJ45 connections for the ESP ISDN/RJ45-4/8 or ESP ISDN/RJ45-8/8 plug-in ISDN protectors for use if the standard 0.5 m cable is insufficient

Full product range order codes can be found on pages 17/8-17/9

Protector accessories

Accessories



Slim Line replacement base/module

Slim Line replacement base/module

Replacement: Base & module for the Slim Line Series of protectors

Part no.	Description
Slim Line protector replacement base	
ESP SL/B	For use with standard and 4-20 mA Slim Line Series
ESP SL/I/B	Isolated screen version for use with standard and 4-20 mA Slim Line Series
ESP SLX/B	For use with Slim Line Intrinsically Safe (ATEX) Series
ESP SLX/I/B	Isolated screen version for use with Slim Line Intrinsically Safe (ATEX) Series
ESP SL/3W/B	For use with Slim Line 3-wire Series
ESP SLRTD/B	For use with Slim Line RTD Series
ESP SL RS485/B	For use with Slim Line RS485 Series

Slim Line protector replacement module

ESP SLXX/M	For use with Slim Line Series - replace 'XX' with relevant voltage, i.e. 06, 15, 30, 50, 110
ESP SLTN/M	For use with Slim Line TN Series
ESP SL15X/M	For use with Slim Line Intrinsically Safe (ATEX) Series, 15 V
ESP SL30X/M	For use with Slim Line Intrinsically Safe (ATEX) Series, 30 V
ESP SLRTD/M	For use with Slim Line RTD Series
ESP SLRS485/M	For use with Slim Line RS485 Series

Slim Line LED protector replacement module

ESP SLXXL/M	For use with Slim Line LED Series - replace 'XX' with relevant voltage, i.e. 06, 15, 30, 50, 110
ESP SL30L/4-20/M	For use with Slim Line LED Series, 4-20 mA
ESP SL15XL/M	For use with Slim Line Intrinsically Safe (ATEX) LED Series, 15 V
ESP SL30XL/M	For use with Slim Line Intrinsically Safe (ATEX) LED Series, 30 V
ESP SLXX/3W/M	For use with Slim Line 3-wire LED Series – replace 'XX' with relevant voltage, i.e. 06, 15, 30, 50, 110

Full product range order codes can be found on pages 17/8-17/9



Connecting and earthing bar

Connecting and earthing bar

Use with: ESP WT protectors

Part no.	Description
ESP CE7	For use with 3 x ESP 690/12.5/WT for TN-C supplies
ESP CE9	For use with 3 x ESP 690/25/WT for TN-C supplies
ESP CE10	For use with 4 x ESP 690/12.5/WT for TN-S supplies
ESP CE13	For use with 4 x ESP 690/25/WT for TN-S supplies

Full product range order codes can be found on pages 17/8-17/9



ESP PTE002

ESP PTE002

Use to: Test the ESP SSI/M protector

Part no.	Description
ESP PTE002	SSI Portable Tester

ESP PTE002 has Network Rail Approval PA05/02216. NRS PADS reference 094/020033 Annual calibration is required, which is processed as ESP PTE002/CAL

Full product range order codes can be found on pages 17/8-17/9



ESP RF mounting plates

ESP RF mounting plates

Use with: Any ESP RF protector to assist installation

Part no.	Description
ESP SL/B	Straight Mounting plate
ESP RF BK2	90° Mounting plate
ESP RF BK3	Bulkhead through mounting plate (single)
ESP RF BK4	Bulkhead through mounting plate (4 protectors)

Full product range order codes can be found on pages 17/8-17/9



ESP RF GDT-x

ESP RF GDT-x

Replacement: Gas Discharge Tubes for use with standard RF protectors

Part no.	Description	Voltage
ESP SL/B	Gas Discharge Tube	90 V
ESP RF GDT-2	Gas Discharge Tube	150 V
ESP RF GDT-3	Gas Discharge Tube	230 V
ESP RF GDT-4	Gas Discharge Tube	350 V
ESP RF GDT-5	Gas Discharge Tube	470 V
ESP RF GDT-6	Gas Discharge Tube	600 V

Part no.	Description	GDT Voltage
ESP RF GDT-A	Gas Discharge Tube	600 V

Replacement Gas Discharge Tube for use with the ESP RF 111A11, ESP RF AA1A11 and ESP RF 441A11 protectors

Full product range order codes can be found on pages 17/8-17/9



Technical reference

Technical reference

Introduction	16/2
Key points	16/4
IEC/BS EN 62305-1 - General principles	16/5
IEC/BS EN 62305-1 - Lightning protection levels (LPL)	16/6
IEC/BS EN 62305-1 - Lightning protection zones (LPZ)	16/7
IEC/BS EN 62305-2 - Risk management	16/8
IEC/BS EN 62305-3 - Physical damage to structures & life hazard	16/9
IEC/BS EN 62305-4 - Electrical & electronic systems within structures	16/16
IEC/BS EN 62561 series - Lightning protection system components	16/20
Earthing standards	16/22
Lightning protection to NFPA & UL standards	16/23
Overvoltage protection to BS 7671	16/24
BS EN 61643 standard series	16/25
Lightning protection of hazardous areas to ATEX/IECEX	16/26

Technical reference

Introduction



The IEC/BS EN 62305 standard reflects increased scientific understanding of lightning and its effects over the last twenty years, and takes stock of the growing impact of technology and electronic systems on our daily activities.

IEC/BS EN 62305 Lightning protection standard

The IEC/BS EN 62305 Standard for lightning protection was originally published in September 2006, to supersede the previous standard, BS 6651:1999.

For a limited period, IEC/BS EN 62305 and BS 6651 ran in parallel, but in August 2008, BS 6651 was withdrawn and now IEC/BS EN 62305 is the recognized standard for lightning protection.

More complex and exacting than its predecessor, IEC/BS EN 62305 includes four distinct parts - general principles, risk management, physical damage to structures and life hazard, and electronic systems protection.

These parts to the standard are introduced here. In 2010 these parts underwent periodic technical review, with updated parts 1, 3 and 4 released in 2011, with part 2 published in 2012.

Key to IEC/BS EN 62305 is that all considerations for lightning protection are driven by a comprehensive and complex risk assessment and that this assessment not only takes into account the structure to be protected, but also the services to which the structure is connected. In essence, structural lightning protection can no longer be considered in isolation, protection against transient overvoltages or electrical surges is integral to IEC/BS EN 62305.



Structure of IEC/BS EN 62305

The IEC/BS EN 62305 series consists of four parts, all of which need to be taken into consideration. These four parts are outlined opposite:

Part 1: General principles

IEC/BS EN 62305-1 (part 1) is an introduction to the other parts of the standard and essentially describes how to design a Lightning Protection System (LPS) in accordance with the accompanying parts of the standard.

Part 2: Risk management

IEC/BS EN 62305-2 (part 2) risk management approach, does not concentrate so much on the purely physical damage to a structure caused by a lightning discharge, but more on the risk of loss of human life (including permanent injury), loss of service to the public, loss of cultural heritage and economic loss.

Part 3: Physical damage to structures and life hazard

IEC/BS EN 62305-3 (part 3) relates directly to the major part of BS 6651. It differs from BS 6651 in as much that this new part has four Classes or protection levels of LPS, as opposed to the basic two (ordinary and high-risk) levels in BS 6651.

Figure 2. Structure of IEC/BS EN 62305

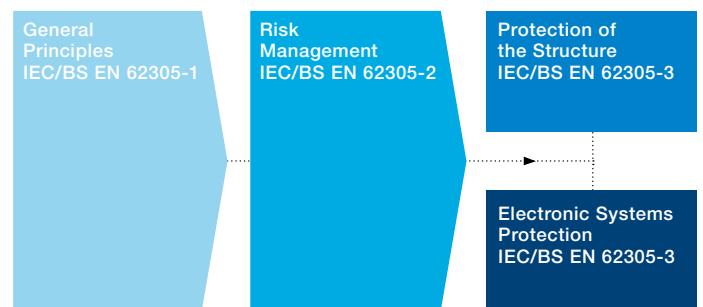

Part 4: Electrical and electronic systems within structures

IEC/BS EN 62305-4 (part 4) covers the protection of electrical and electronic systems housed within structures. It embodies what Annex C in BS 6651 conveyed, but with a new zonal approach referred to as Lightning Protection Zones (LPZs). It provides information for the design, installation, maintenance and testing of a Lightning Electromagnetic Impulse (LEMP) protection system (now referred to as Surge Protection Measures - SPM) for electrical/electronic systems within a structure.

Technical reference

Key points

Key variances between the previous standard, BS 6651, and the IEC/BS EN 62305 - Technical reference table

BS 6651 Standard (withdrawn August 2008)	IEC/BS EN 62305 Standard
Document structure	
118 page document, including 9 pages devoted to risk assessment	Over 470 pages in 4 parts, including over 150 pages devoted to risk assessment (IEC/BS EN 62305-2)
Focus on Protection of Structures against Lightning	Broader focus on Protection against Lightning including the structure and services connected to the structure
Specific tables relating to choice and dimension of LPS components and conductors	Specific tables relating to sizes and types of conductor and earth electrodes LPS components - specifically related to BS EN 50164/IEC 62561 testing regimes
Annex B - guidance on application of BS 6651	IEC/BS EN62305-3 Annex E - extensive guidance given on application of installation techniques complete with illustrations
Annex C - general advice (recommendation) for protection of electronic equipment with separate risk assessment	IEC/BS EN 62305-4 is devoted entirely to protection of electrical and electronic systems within the structure (integral part of standard) and is implemented through single separate risk assessment (IEC/BS EN 62305-2)
Definition of risk	
Risk (of death/injury) level set at 1 in 100,000 (1×10^{-5}) based on comparable exposures (smoking, traffic accidents, drowning etc)	3 primary risk levels defined (IEC/BS EN 62305): – R_1 Loss of human life (including permanent injury) 1 in 100,000 (1×10^{-5}) – R_2 Loss of service to the public 1 in 10,000 (1×10^{-4}) – R_3 Loss of cultural heritage 1 in 10,000 (1×10^{-4})
Protection measures	
Mesh arrangement is promoted as the commonly used means of air termination network	Mesh arrangement, protective angle method, catenary system, extensive use of air finials, all form part of or all of air termination network
2 levels of Lightning Protection mesh design: (20 m x 10 m; 10 m x 5 m)	4 sizes of mesh defined according to structural class of Lightning Protection System: – Class I 5 m x 5 m – Class II 10 m x 10 m – Class III 15 m x 15 m – Class IV 20 m x 20 m
2 levels of down conductor spacing: 20 m & 10 m	4 levels of down conductor spacing dependent on structural class of Lightning Protection System: – Class I 10 m – Class II 10 m – Class III 15 m – Class IV 20 m
Use of bonds promoted to minimize side flashing	Extensive sections/explanations provided on equipotential bonding
10 Ω overall earthing requirement, achieved by 10 x number of down conductors	10 Ω overall earthing requirement achieved either by Type A arrangement (rods) or Type B arrangement (ring conductor)
Requirement to bond all metallic services, (gas, water, electricity etc) to main earth terminal along with external down conductor	Requirement to bond all metallic services to main equipotential bonding bar. 'Live' electrical conductors (e.g. power, data, telecoms) bonded via Surge Protective Devices (SPDs)
Use of bonds promoted to minimize side flashing	Via mounting fixtures
Rolling sphere concept on structures over 20 m tall: 20 m sphere used on highly flammable contents/electronic equipment within building 60 m sphere all other buildings	4 sizes of rolling sphere concept defined according to structural class of Lightning Protection System: – Class I 20 m – Class II 30 m – Class III 45 m – Class IV 60 m

Technical reference

IEC/BS EN 62305-1 - General principles

This opening part of the IEC/BS EN 62305 suite of standards serves as an introduction to the further parts of the standard. It classifies the sources and types of damage to be evaluated and introduces the risks or types of loss to be anticipated as a result of lightning activity.

Furthermore, It defines the relationships between damage and loss that form the basis for the risk assessment calculations in part 2 of the standard.

Lightning current parameters are defined. These are used as the basis for the selection and implementation of the appropriate protection measures detailed in parts 3 and 4 of the standard.

Part 1 of the standard also introduces new concepts for consideration when preparing a lightning protection scheme, such as Lightning Protection Zones (LPZs) and separation distance.

Damage and loss

IEC/BS EN 62305 identifies four main sources of damage:

- **S1** Flashes to the structure
- **S2** Flashes near to the structure
- **S3** Flashes to the lines connected to the structure
- **S4** Flashes near the lines connected to the structure

Each source of damage may result in one or more of three types of damage:

- **D1** Injury of living beings by electric shock
- **D2** Physical damage (fire, explosion, mechanical destruction, chemical release) due to lightning current effects including sparking
- **D3** Failure of internal systems due to Lightning Electromagnetic Impulse (LEMP)

The following types of loss may result from damage due to lightning:

- **L1** Loss of human life (including permanent injury)
- **L2** Loss of service to the public
- **L3** Loss of cultural heritage
- **L4** Loss of economic value (structure, its content, and loss of activity)

The relationships of all of the above parameters are summarized in Table 5.

Table 5: Damage and loss in a structure according to point of lightning strike (IEC/BS EN 62305-1 Table 2)

Point of strike	Source of damage	Type of damage	Type of loss
Structure	S1	D1	L1, L4**
		D2	L1, L2, L3, L4
		D3	L1*, L2, L4
Near a Structure	S2	D3	L1*, L2, L4
Lines connected to the structure	S3	D1	L1, L4**
		D2	L1, L2, L3, L4
		D3	L1*, L2, L4
Near a Line	S4	D3	L1*, L2, L4

*Only for structures with risk of explosion and for hospitals or other structures where failures of internal systems immediately endangers human life

**Only for properties where animals may be lost

For a more detailed explanation of the general principles forming part 1 of the BS EN 62305 standard, please refer to our full reference guide 'A Guide to IEC/BS EN 62305 Protection Against Lightning'. Although focused on the BS EN standard, this guide may provide supporting information of interest to consultants designing to the IEC equivalent.

Scheme design criteria

The ideal lightning protection for a structure and its connected services would be to enclose the structure within an earthed and perfectly conducting metallic shield (box), and in addition provide adequate bonding of any connected services at the entrance point into the shield.

This in essence would prevent the penetration of the lightning current and the induced electromagnetic field into the structure. However, in practice it is not possible or indeed cost effective to go to such lengths.

This standard thus sets out a defined set of lightning current parameters where protection measures, adopted in accordance with its recommendations, will reduce any damage and consequential loss as a result of a lightning strike. This reduction in damage and consequential loss is valid provided the lightning strike parameters fall within defined limits, established as Lightning Protection Levels (LPL).

Technical reference

IEC/BS EN 62305-1 - Lightning protection levels (LPL)

Lightning Protection Levels (LPL)

Four protection levels have been determined based on parameters obtained from previously published technical papers. Each level has a fixed set of maximum and minimum lightning current parameters. These parameters are shown in Table 6.

The maximum values have been used in the design of products such as lightning protection components and Surge Protective Devices (SPDs).

The minimum values of lightning current have been used to derive the rolling sphere radius for each level.

Table 6: Lightning current for each LPL based on 10/350 μ s waveform

LPL	I	II	III	IV
Maximum current (kA)	200	150	100	100
Minimum current (kA)	3	5	10	16

For a more detailed explanation of Lightning Protection Levels and maximum/minimum current parameters please see the Furse Guide to BS EN 62305.

Figure 3. The types of damage and loss resulting from a lightning strike on or near a structure

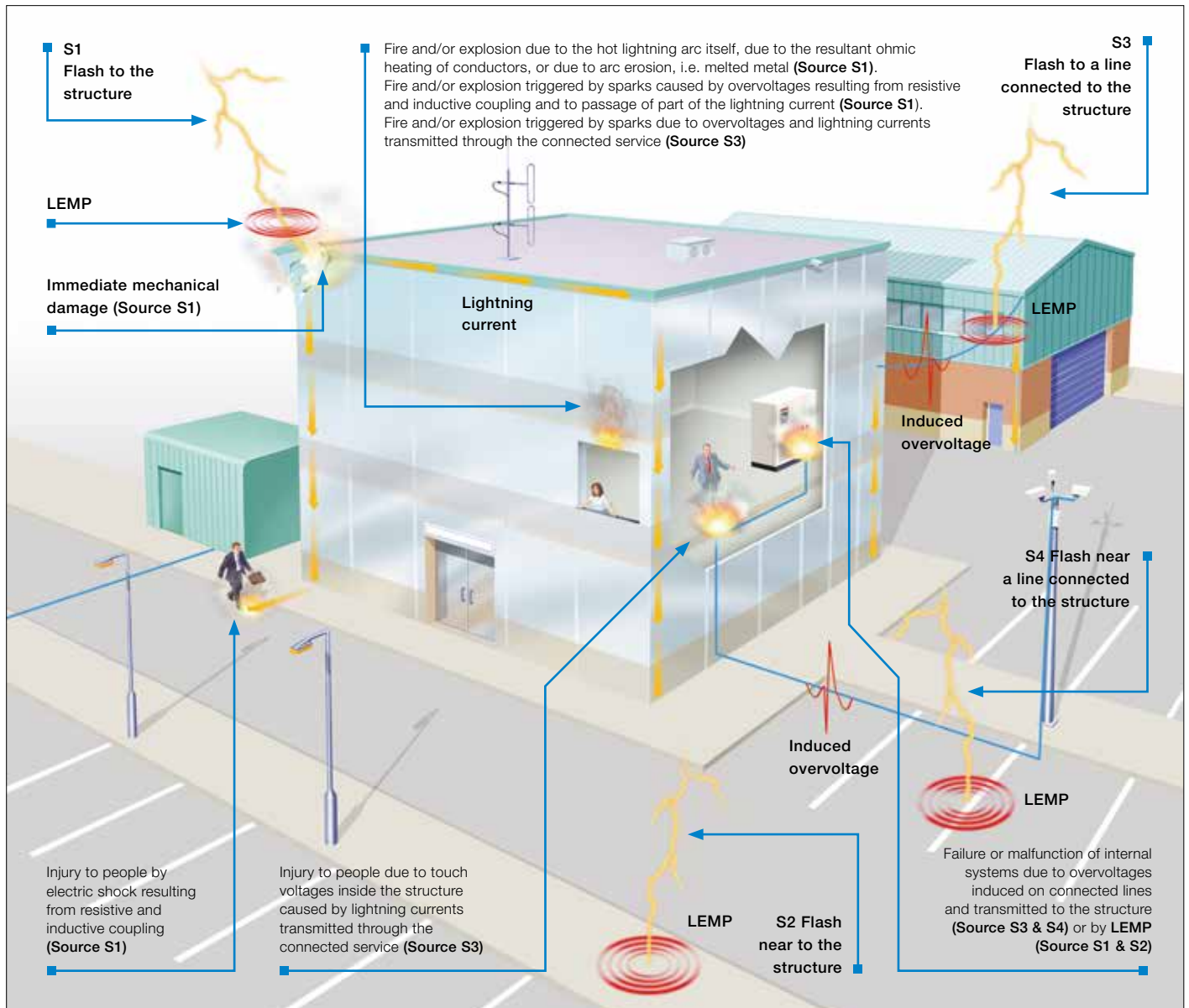

Technical reference

IEC/BS EN 62305-1 - Lightning protection zones (LPZ)

Lightning protection zones (LPZ)

The concept of the Lightning Protection Zone (LPZ) was introduced within IEC/BS EN 62305 particularly to assist in determining the protection measures required to establish protection measures to counter Lightning Electromagnetic Impulse (LEMP) within a structure.

The general principle is that the equipment requiring protection should be located in an LPZ whose electromagnetic characteristics are compatible with the equipment stress withstand or immunity capability.

The concept caters for external zones, with risk of direct lightning strike, or partial lightning current occurring (LPZ 0) and levels of protection within internal zones (LPZ 1 & LPZ 2).

In general the higher the number of the zone (LPZ 2; LPZ 3 etc) the lower the electromagnetic effects expected. Typically, any sensitive electronic equipment should be located in higher numbered LPZs and be protected against LEMP by relevant Surge Protection Measures (SPM as defined in BS EN 62305).

SPM were previously referred to as a LEMP Protection Measures System (LPMS) in IEC/BS EN 62305:2006.

Figure 4 highlights the LPZ concept as applied to the structure and to SPM. The concept is expanded upon in IEC/BS EN 62305-3 and IEC/BS EN 62305-4.

Selection of the most suitable SPM is made using the risk assessment in accordance with IEC/BS EN 62305-2.

Figure 4. The LPZ concept

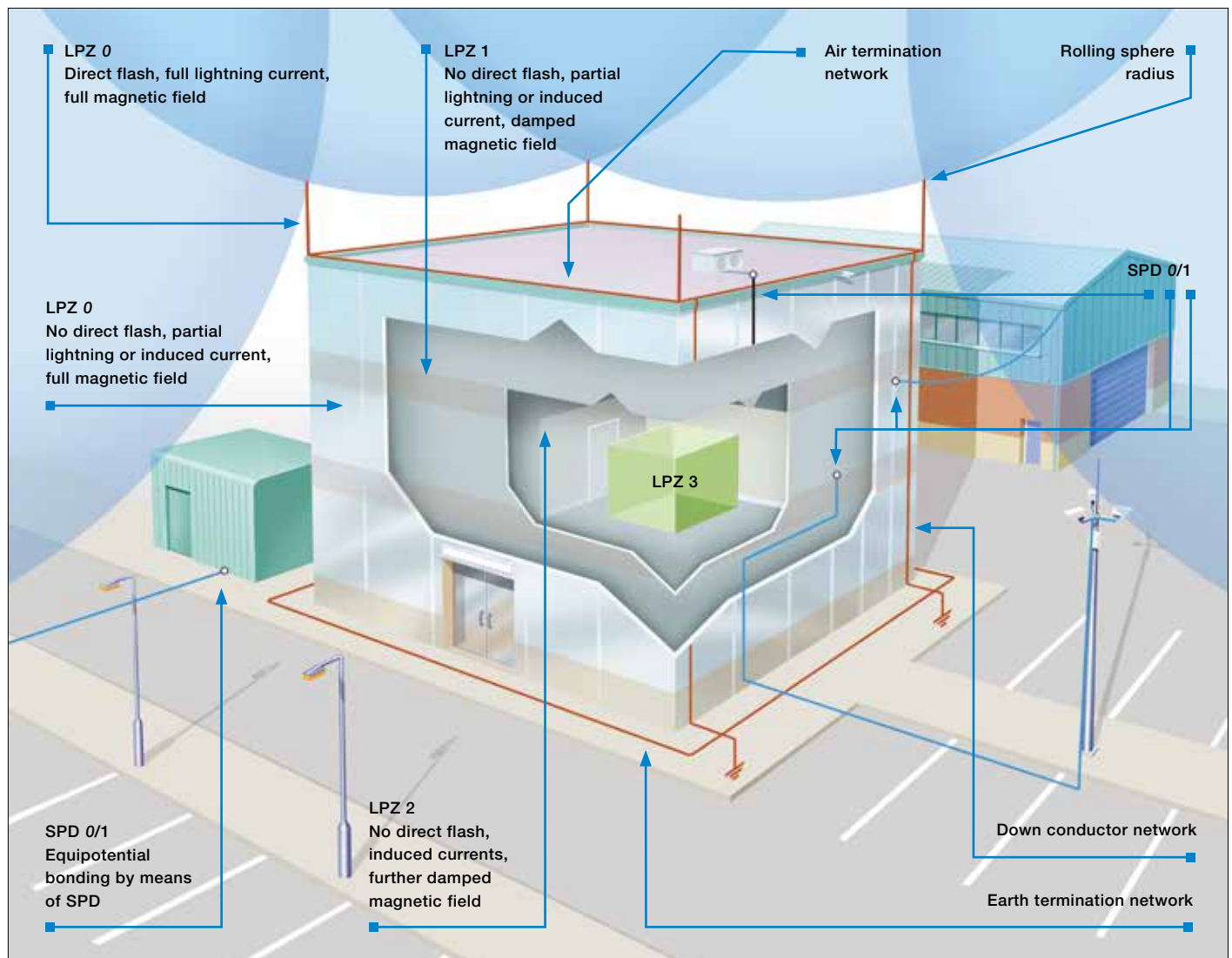

Technical reference

IEC/BS EN 62305-2 - Risk management

IEC/BS EN 62305-2 is key to the correct implementation of IEC/BS EN 62305-3 and IEC/BS EN 62305-4. The assessment and management of risk is now significantly more in depth and extensive than the approach of BS 6651.

IEC/BS EN 62305-2 specifically deals with making a risk assessment, the results of which define the level of Lightning Protection System (LPS) required. While BS 6651 devoted 9 pages (including figures) to the subject of risk assessment, IEC/BS EN 62305-2 currently contains over 140 pages.

The first stage of the risk assessment is to identify which of the four types of loss (as identified in IEC/BS EN 62305-1) the structure and its contents can incur. The ultimate aim of the risk assessment is to quantify and if necessary reduce the relevant primary risks i.e.:

- R_1 risk of loss of human life (including permanent injury)
- R_2 risk of loss of service to the public
- R_3 risk of loss of cultural heritage
- R_4 risk of loss of economic value

For each of the first three primary risks, a tolerable risk (R_T) is set. This data can be sourced in Table 7 of IEC 62305-2 or Table NF.1 of the National Annex of BS EN 62305-2.

Each primary risk (R_n) is determined through a long series of calculations as defined within the standard. If the actual risk (R_n) is less than or equal to the tolerable risk (R_T), then no protection measures are needed. If the actual risk (R_n) is greater than its corresponding tolerable risk (R_T), then protection measures must be instigated. The above process is repeated (using new values that relate to the chosen protection measures) until R_n is less than or equal to its corresponding R_T .

It is this iterative process as shown in Figure 5 that decides the choice or indeed Lightning Protection Level (LPL) of Lightning Protection System (LPS) and Surge Protective Measures (SPM) to counter Lightning Electromagnetic impulse (LEMP).

Figure 5. Procedure for deciding the need for protection (IEC/BS EN 62305-1 Figure 1)

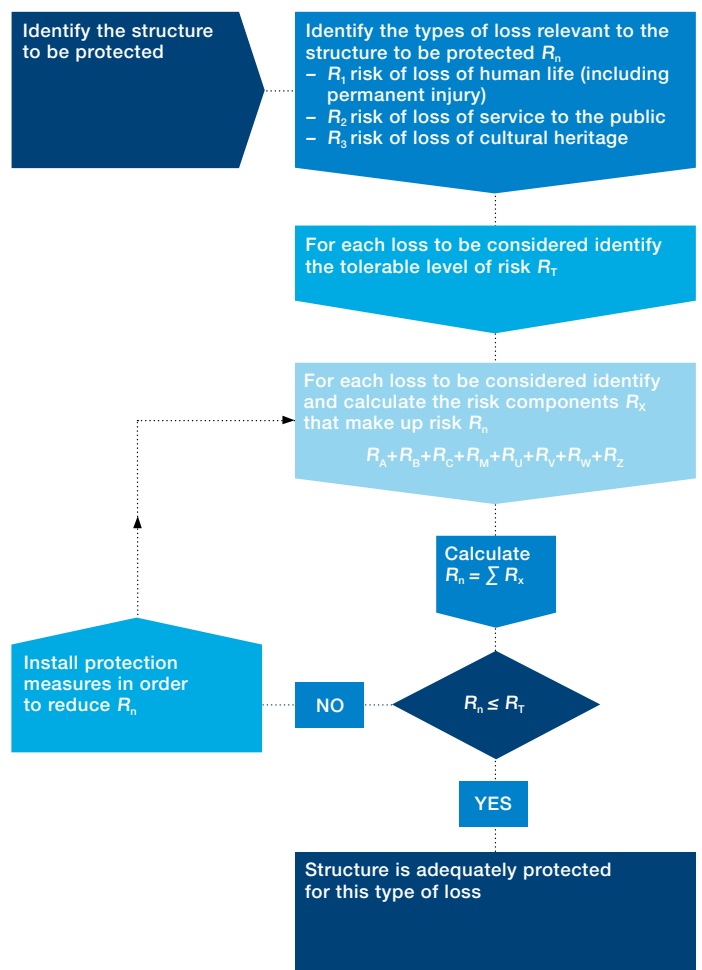

StrikeRisk risk management software

An invaluable tool for those involved in undertaking the complex risk assessment calculations required by IEC/BS EN 62305-2, StrikeRisk facilitates the assessment of risk of loss due to lightning strikes and transient overvoltages caused by lightning.

Quick and easy to use, with full reporting capability, StrikeRisk automates risk assessment calculations and delivers results in minutes, rather than the hours or days it would take to do the same calculations by hand. Contact Furse for more details about StrikeRisk.

Technical reference

IEC/BS EN 62305-3 - Physical damage to structures & life hazard

IEC/BS EN 62305-3. This part of the suite of standards deals with protection measures in and around a structure.

The main body of this part of the standard gives guidance on the design of an external Lightning Protection System (LPS), internal LPS and maintenance and inspection programmes.

Lightning Protection System (LPS)

IEC/BS EN 62305-1 has defined four Lightning Protection Levels (LPLs) based on probable minimum and maximum lightning currents. These LPLs equate directly to classes of Lightning Protection System (LPS).

The correlation between the four levels of LPL and LPS is identified in Table 7. In essence, the greater the LPL, the higher class of LPS is required.

External LPS design considerations

The lightning protection designer must initially consider the thermal and explosive effects caused at the point of a lightning strike and the consequences to the structure under consideration. Depending upon the consequences the designer may choose either of the following types of external LPS:

- Isolated
- Non-isolated

External LPS design considerations

An Isolated LPS is typically chosen when the structure is constructed of combustible materials or presents a risk of explosion.

Conversely a non-isolated system may be fitted where no such danger exists.

An external LPS consists of:

- Air termination system
- Down conductor system
- Earth termination system

These individual elements of an LPS should be connected together using appropriate lightning protection components (LPC) complying (in the case of BS EN 62305) with IEC/BS EN 62561 series. This will ensure that in the event of a lightning current discharge to the structure, the correct design and choice of components will minimize any potential damage.

Table 7: Relation between Lightning Protection Level (LPL) and Class of LPS (IEC/BS EN 62305-3 Table 1)

LPL	Class of LPS
I	I
II	II
III	III
IV	IV

Air termination system

The role of an air termination system is to capture the lightning discharge current and dissipate it harmlessly to earth via the down conductor and earth termination system. Therefore it is important to use a correctly designed air termination system.

IEC/BS EN 62305-3 advocates the following, in any combination, for the design of the air termination:

- Air rods (or finials) whether they are free-standing masts or linked with conductors to form a mesh on the roof
- Catenary (or suspended) conductors, whether they are supported by free-standing masts or linked with conductors to form a mesh on the roof
- Meshed conductor network that may lie in direct contact with the roof or be suspended above it (in the event that it is of paramount importance that the roof is not exposed to a direct lightning discharge)

The standard makes it quite clear that all types of air termination systems that are used shall meet the positioning requirements laid down in the body of the standard. It highlights that the air termination components should be installed on corners, exposed points and edges of the structure.

The three basic methods recommended for determining the position of the air termination systems are:

- The rolling sphere method
- The protective angle method
- The mesh method

These methods are detailed over the following pages.

Technical reference

IEC/BS EN 62305-3 - Physical damage to structures & life hazard

The rolling sphere method

The rolling sphere method is a simple means of identifying areas of a structure that need protection, taking into account the possibility of side strikes to the structure. The basic concept of applying the rolling sphere to a structure is illustrated in Figure 6.

The rolling sphere method was used in BS 6651, the only difference being that in IEC/BS EN 62305 there are different radii of the rolling sphere that correspond to the relevant class of LPS (see Table 8). This method is suitable for defining zones of protection for all types of structures, particularly those of complex geometry.

The protective angle method

The protective angle method is a mathematical simplification of the rolling sphere method. The protective angle (α) is the angle created between the tip (A) of the vertical rod and a line projected down to the surface on which the rod sits (see Figure 7).

The protective angle afforded by an air rod is clearly a three dimensional concept whereby the rod is assigned a cone of protection by sweeping the line AC at the angle of protection a full 360° around the air rod.

The protective angle differs with varying height of the air rod and class of LPS. The protective angle afforded by an air rod is determined from Table 2 of IEC/BS EN 62305-3 (see Figure 9).

Table 8: Max. values of rolling sphere radius corresponding to the Class of LPS

Class of LPS	Rolling sphere radius
I	20 m
II	30 m
III	45 m
IV	60 m

Table 9: Max. values of mesh size corresponding to the Class of LPS

Class of LPS	Mesh size
I	5 x 5 m
II	10 x 10 m
III	15 x 15 m
IV	20 x 20 m

Varying the protection angle is a change to the simple 45° zone of protection afforded in most cases in BS 6651. Furthermore the new standard uses the height of the air termination system above the reference plane, whether that be ground or roof level (See Figure 8).

The protective angle method is better suited for simple shaped buildings. However this method is only valid up to a height equal to the rolling sphere radius of the appropriate LPL.

Figure 6. Application of the rolling sphere method

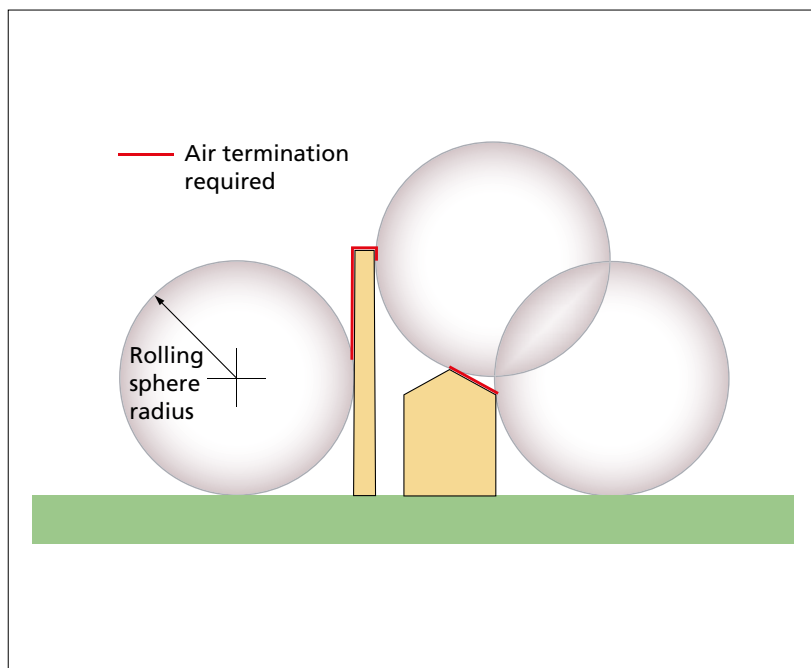
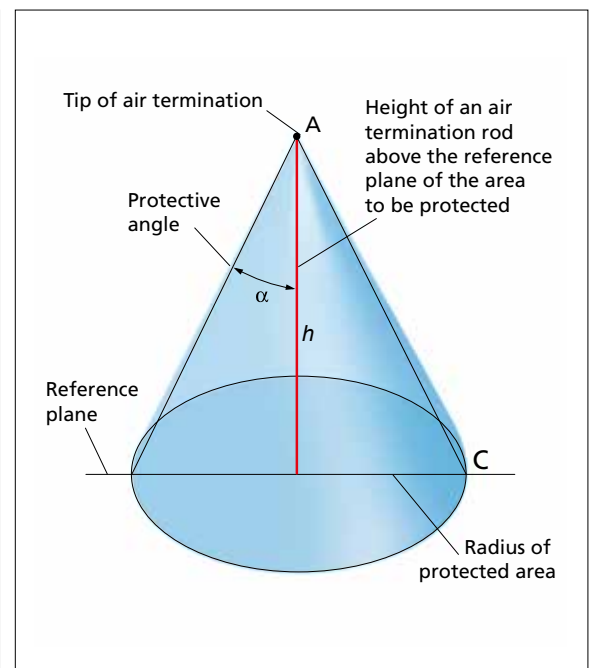

Figure 7. The protective angle method for a single air rod



The mesh method

IEC/BS EN 62305 lists four different air termination mesh sizes that are defined and correspond to the relevant class of LPS (see Table 9).

This method is suitable where plain surfaces require protection if the following conditions are met:

- Air termination conductors must be positioned at roof edges, on roof overhangs and on the ridges of roof with a pitch in excess of 1 in 10 (5.7°)
- No metal installation protrudes above the air termination system

Modern research on lightning inflicted damage has shown that the edges and corners of roofs are most susceptible to damage. So on all structures particularly with flat roofs, perimeter conductors should be installed as close to the outer edges of the roof as is practicable.

The IEC/BS EN 62305 Standard permits the use of conductors (whether they be fortuitous metalwork or dedicated LP conductors) under the roof. Vertical air rods (finials) or strike plates should be mounted above the roof and connected to the conductor system beneath.

Figure.9 Determination of the protective angle (IEC/BS EN 62305-3 Table 2)

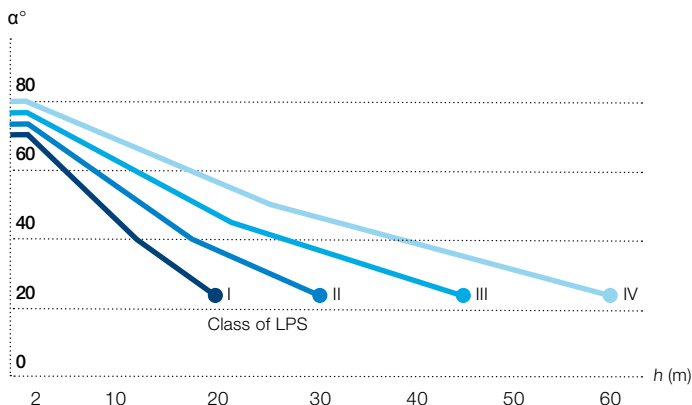

- Note 1:** Not applicable beyond the values marked with ●
Only rolling sphere and mesh methods apply in these cases
- Note 2:** h is the height of air-termination above the reference plane of the area to be protected
- Note 3:** The angle will not change for values of h below 2m

The air rods should be spaced not more than 10 m apart and if strike plates are used as an alternative, these should be strategically placed over the roof area not more than 5 m apart.

Figure 8. Effect of the height of the reference plane on the protection angle

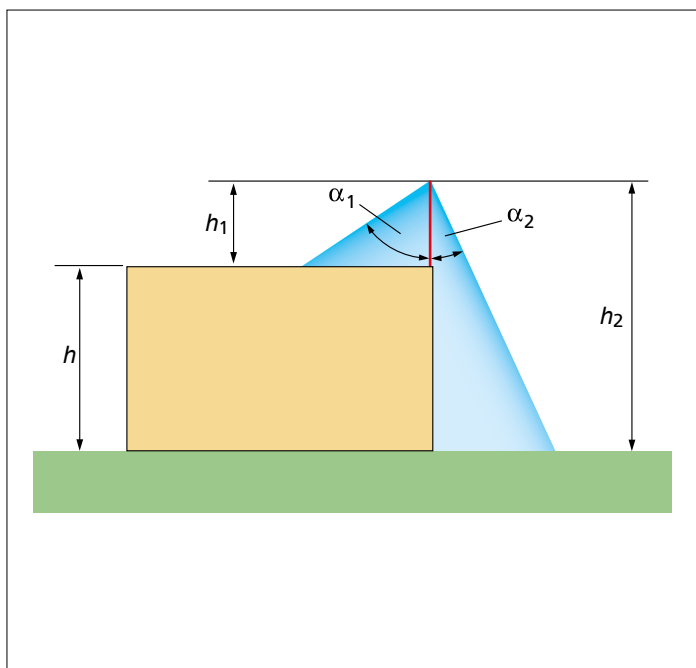
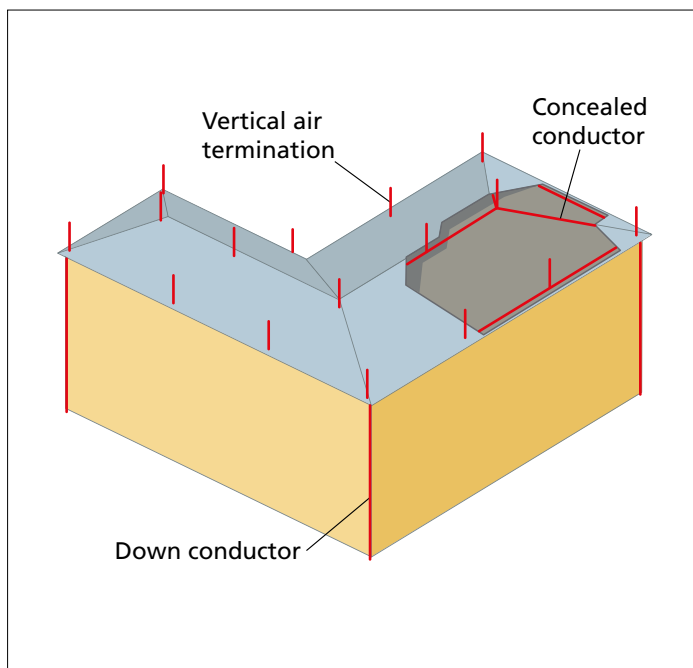

Figure 10. Concealed air termination network



Technical reference

IEC/BS EN 62305-3 - Physical damage to structures & life hazard

Non-conventional air termination systems

A lot of technical (and commercial) debate has raged over the years regarding the validity of the claims made by the proponents of such systems. This topic was discussed extensively within the technical working groups that compiled IEC/BS EN 62305. The outcome was to remain with the information housed within this standard.

IEC/BS EN 62305 states unequivocally that the volume or zone of protection afforded by the air termination system (e.g. air rod) shall be determined only by the real physical dimension of the air termination system. This statement is reinforced within the 2011 version of BS EN 62305, by being incorporated in the body of the standard, rather than forming part of an Annex (Annex A of IEC/BS EN 62305-3:2006).

Typically if the air rod is 5 m tall then the only claim for the zone of protection afforded by this air rod would be based on 5 m and the relevant class of LPS and not any enhanced dimension claimed by some nonconventional air rods.

There is no other standard being contemplated to run in parallel with this standard IEC/BS EN 62305.

Natural components

When metallic roofs are being considered as a natural air termination arrangement, IEC/BS EN 62305 offers guidance on the minimum thickness and type of material under consideration, as well as additional information if the roof has to be considered puncture proof from a lightning discharge (see Table 10).

Table 10: Minimum thickness of metal sheets or metal pipes in air termination systems (IEC/BS EN 62305-3 Table 3)

Class of LPS	Material	Thickness ⁽¹⁾ t	Thickness ⁽²⁾ t'
I to IV	Lead	–	2.0 mm
	Steel (stainless, galvanized)	4 mm	0.5 mm
	Titanium	4 mm	0.5 mm
	Copper	5 mm	0.5 mm
	Aluminium	7 mm	0.65 mm
	Zinc	–	0.7 mm

⁽¹⁾ Thickness t prevents puncture, hot spot or ignition

⁽²⁾ Thickness t' only for metal sheets if it is not important to prevent puncture, hot spot or ignition problems

Table 11: Typical values of the distance between down conductors according to the Class of LPS (IEC/BS EN 62305-3 Table 4)

Class of LPS	Typical distances
I	10 m
II	10 m
III	15 m
IV	20 m

Down conductors

Down conductors should within the bounds of practical constraints take the most direct route from the air termination system to the earth termination system. The greater the number of down conductors the better the lightning current is shared between them. This is enhanced further by equipotential bonding to the conductive parts of the structure.

Lateral connections sometimes referred to as coronal bands or ring conductors provided either by fortuitous metalwork or external conductors at regular intervals are also encouraged. The down conductor spacing should correspond with the relevant class of LPS (see Table 11).

There should always be a minimum of two down conductors distributed around the perimeter of the structure. Down conductors should wherever possible be installed at each exposed corner of the structure as research has shown these to carry the major part of the lightning current.

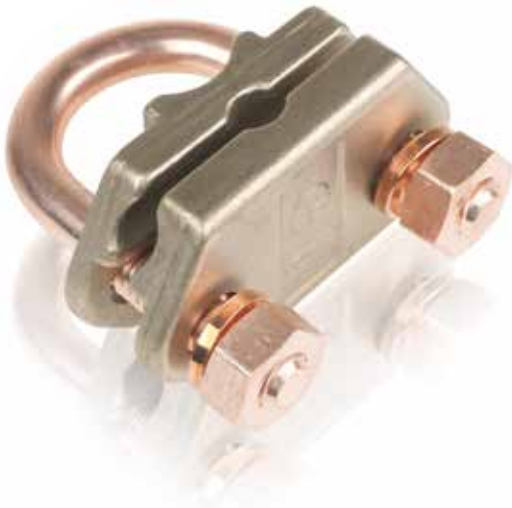

Natural components

IEC/BS EN 62305 encourages the use of fortuitous metal parts on or within the structure to be incorporated into the LPS. That these are welded, clamped with suitable connection components or overlapped a minimum of 20 times the rebar diameter. This is to ensure that those reinforcing bars likely to carry lightning currents have secure connections from one length to the next.

When internal reinforcing bars are required to be connected to external down conductors or earthing network either of the arrangements shown in Figure 6 is suitable. If the connection from the bonding conductor to the rebar is to be encased in concrete then the standard recommends that two clamps are used, one connected to one length of rebar and the other to a different length of rebar. The joints should then be encased by a moisture inhibiting compound such as Denso tape.

If the reinforcing bars (or structural steel frames) are to be used as down conductors then electrical continuity should be ascertained from the air termination system to the earthing system. For new build structures this can be decided at the early construction stage by using dedicated reinforcing bars or alternatively to run a dedicated copper conductor from the top of the structure to the foundation prior to the pouring of the concrete. This dedicated copper conductor should be bonded to the adjoining/adjacent reinforcing bars periodically.

If there is doubt as to the route and continuity of the reinforcing bars within existing structures then an external down conductor system should be installed. These should ideally be bonded into the reinforcing network of the structures at the top and bottom of the structure.

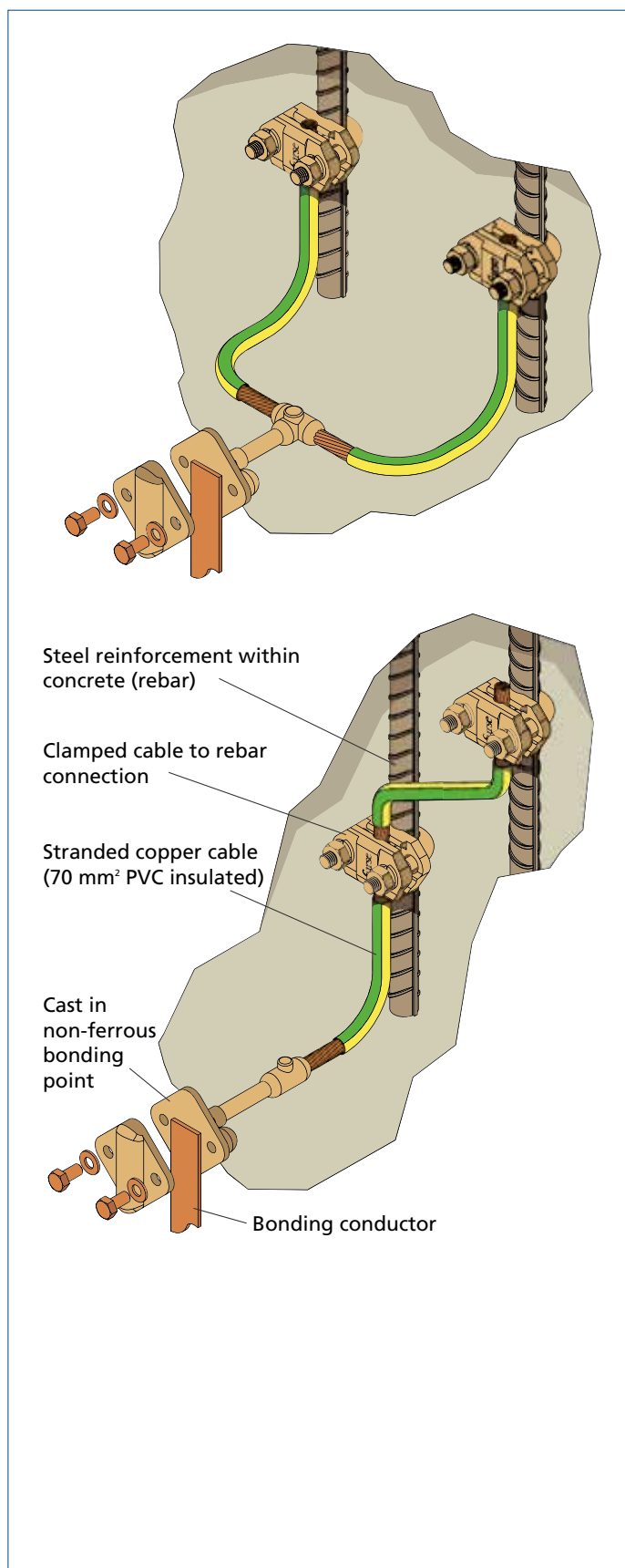

Figure 11. Typical methods of bonding to steel reinforcement within concrete

Technical reference

IEC/BS EN 62305-3 - Physical damage to structures & life hazard

Earth termination system

The earth termination system is vital for the dispersion of lightning current safely and effectively into the ground.

The standard recommends a single integrated earth termination system for a structure, combining lightning protection, power and telecommunication systems. The agreement of the operating authority or owner of the relevant systems should be obtained prior to any bonding taking place.

A good earth connection should possess the following characteristics:

- Low electrical resistance between the electrode and the earth. The lower the earth electrode resistance the more likely the lightning current will choose to flow down that path in preference to any other, allowing the current to be conducted safely to and dissipated in the earth
- Good corrosion resistance. The choice of material for the earth electrode and its connections is of vital importance. It will be buried in soil for many years so has to be totally dependable

The standard advocates a low earthing resistance requirement and points out that the earthing system should have an overall resistance to earth path of 10 Ohms or less. Three basic earth electrode arrangements are used:

- Type A arrangement
- Type B arrangement
- Foundation earth electrodes

Type A arrangement

This consists of horizontal or vertical earth electrodes, connected to each down conductor fixed on the outside of the structure.

Type B arrangement

This arrangement is essentially a fully connected ring earth electrode that is sited around the periphery of the structure and is in contact with the surrounding soil for a minimum 80% of its total length (i.e. 20% of its overall length may be housed in say the basement of the structure and not in direct contact with the earth).

Foundation earth electrodes

This is essentially a type B earthing arrangement. It comprises conductors that are installed in the concrete foundation of the structure. If any additional lengths of electrodes are required they need to meet the same criteria as those for type B arrangement. Foundation earth electrodes can be used to augment the steel reinforcing foundation mesh.

Separation (isolation) distance of the external LPS

A separation distance (i.e. the electrical insulation) between the external LPS and the structural metal parts is essentially required. This will minimize any chance of partial lightning current being introduced internally in the structure.

This can be achieved by placing lightning conductors sufficiently far away from any conductive parts that have routes leading into the structure. So, if the lightning discharge strikes the lightning conductor, it cannot 'bridge the gap' and flash over to the adjacent metalwork.



Internal LPS design considerations

The fundamental role of the internal LPS is to ensure the avoidance of dangerous sparking occurring within the structure to be protected. This could be due, following a lightning discharge, to lightning current flowing in the external LPS or indeed other conductive parts of the structure and attempting to flash or spark over to internal metallic installations.

Carrying out appropriate equipotential bonding measures or ensuring there is a sufficient electrical insulation distance between the metallic parts can avoid dangerous sparking between different metallic parts.

Lightning equipotential bonding

Equipotential bonding is simply the electrical interconnection of all appropriate metallic installations/parts, such that in the event of lightning currents flowing, no metallic part is at a different voltage potential with respect to one another. If the metallic parts are essentially at the same potential then the risk of sparking or flashover is nullified.

This electrical interconnection can be achieved by natural/fortuitous bonding or by using specific bonding conductors that are sized according to Tables 8 and 9 of IEC/BS EN 62305-3.

Bonding can also be accomplished by the use of surge protective devices (SPDs) where the direct connection with bonding conductors is not suitable.

Figure 7 (which is based on IEC/BS EN 62305-3 fig E.43) shows a typical example of an equipotential bonding arrangement. The gas, water and central heating system are all bonded directly to the equipotential bonding bar located inside but close to an outer wall near ground level. The power cable is bonded via a suitable SPD, upstream from the electric meter, to the equipotential bonding bar. This bonding bar should be located close to the main distribution board (MDB) and also closely connected to the earth termination system with short length conductors. In larger or extended structures several bonding bars may be required but they should all be interconnected with each other.

The screen of any antenna cable along with any shielded power supply to electronic appliances being routed into the structure should also be bonded at the equipotential bar.

Further guidance relating to equipotential bonding, meshed interconnection earthing systems and SPD selection can be found in the Furze guide to BS EN 62305.

Figure 12. Example of main equipotential bonding

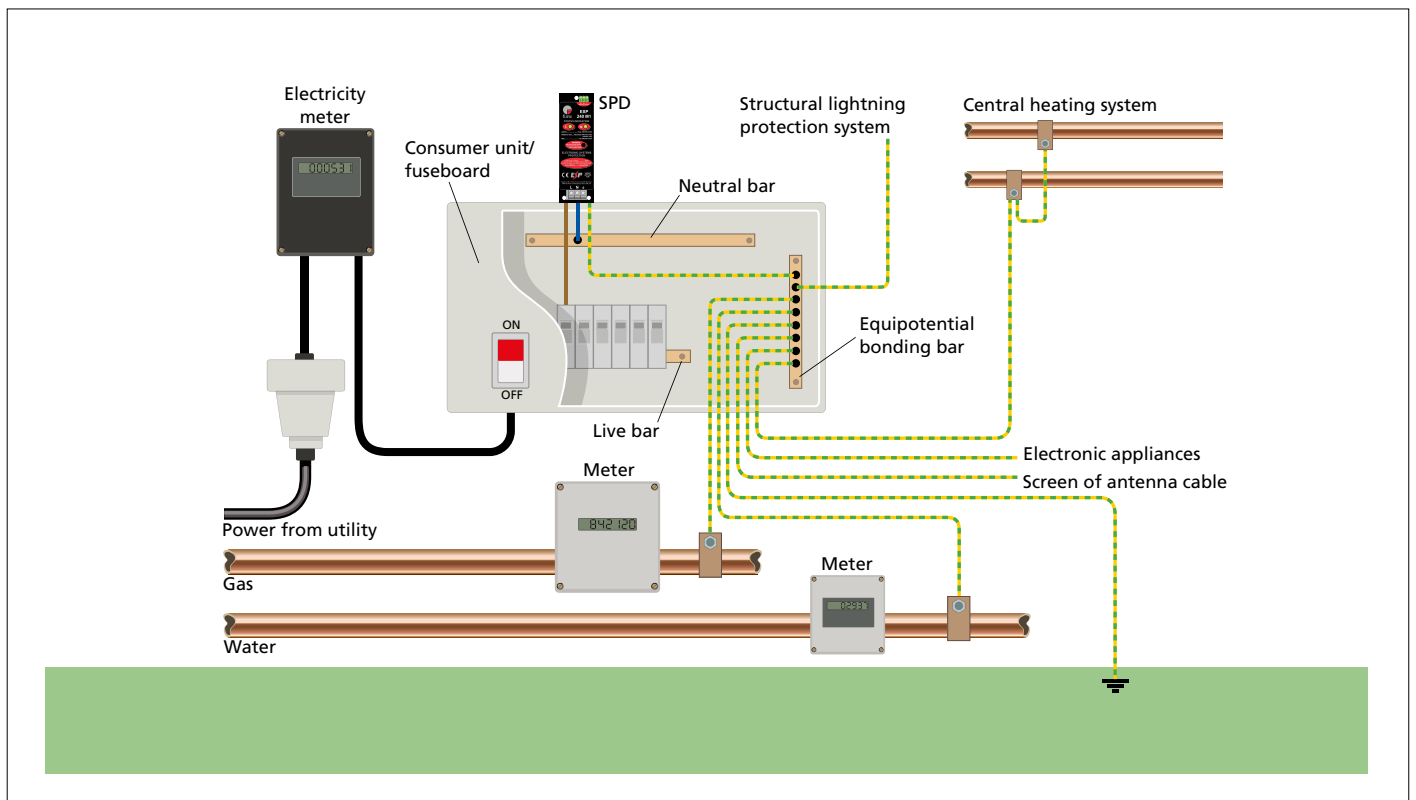

Technical reference

IEC/BS EN 62305-4 - Electrical & electronic systems within structures

Electronic systems now pervade almost every aspect of our lives, from the work environment, through to filling the car with petrol and even shopping at the local supermarket. As a society, we are now heavily reliant on the continuous and efficient running of such systems.

The use of computers, electronic process controls and telecommunications has exploded during the last two decades. Not only are there more systems in existence, the physical size of the electronics involved has reduced considerably (smaller size means less energy required to damage circuits).

IEC/BS EN 62305 accepts that we now live in the electronic age, making LEMP (Lightning Electromagnetic Impulse) protection for electronic and electrical systems integral to the standard through part 4. LEMP is the term given to the overall electromagnetic effects of lightning, including conducted surges (transient overvoltages and currents) and radiated electromagnetic field effects.

LEMP damage is so prevalent such that it is identified as one of the specific types (D3) to be protected against and that LEMP damage can occur from ALL strike points to the structure or connected services - direct or indirect - for further reference to the types of damage caused by lightning see Table 5 on page 16/5. This extended approach also takes into account the danger of fire or explosion associated with services connected to the structure, e.g. power, telecoms and other metallic lines.

Lightning is not the only threat

Transient overvoltages caused by electrical switching events are very common and can be a source of considerable interference. Current flowing through a conductor creates a magnetic field in which energy is stored. When the current is interrupted or switched off, the energy in the magnetic field is suddenly released. In an attempt to dissipate itself it becomes a high voltage transient.

The more stored energy, the larger the resulting transient. Higher currents and longer lengths of conductor both contribute to more energy stored and also released! This is why inductive loads such as motors, transformers and electrical drives are all common causes of switching transients.

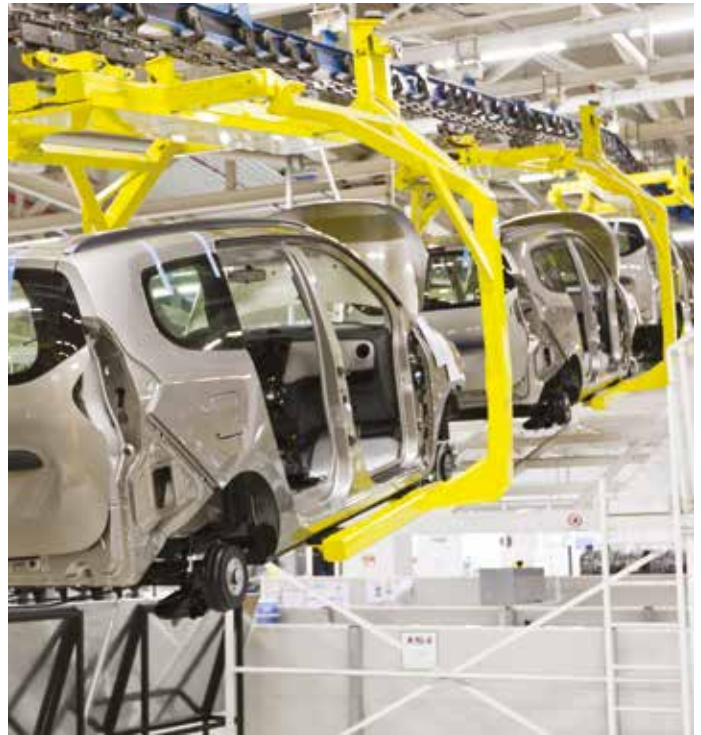

Motors create switching events

Significance of IEC/BS EN 62305-4

Previously transient overvoltage or surge protection was included as an advisory annex in the BS 6651 standard, with a separate risk assessment. As a result protection was often fitted after equipment damage was suffered, often through obligation to insurance companies. However, the single risk assessment in IEC/BS EN 62305 dictates whether structural and/or LEMP protection is required hence structural lightning protection cannot now be considered in isolation from transient overvoltage protection - known as Surge Protective Devices (SPDs) within this new standard. This in itself is a significant deviation from that of BS 6651.

Indeed, as per IEC/BS EN 62305-3, an LPS system can no longer be fitted without lightning current or equipotential bonding SPDs to incoming metallic services that have 'live cores' such as power and telecoms cables which cannot be directly bonded to earth. Such SPDs are required to protect against the risk of loss of human life (including permanent injury) by preventing dangerous sparking that could present fire or electric shock hazards.

Lightning current or equipotential bonding SPDs are also used on overhead service lines feeding the structure that are at risk from a direct strike. However, the use of these SPDs alone “provides no effective protection against failure of sensitive electrical or electronic systems”, to quote IEC/BS EN 62305 part 4, which is specifically dedicated to the protection of electrical and electronic systems within structures.

Lightning current SPDs form one part of a coordinated set of SPDs that include overvoltage SPDs - which are needed in total to effectively protect sensitive electrical and electronic systems from both lightning and switching transients.

Lightning Protection Zones (LPZs)

Whilst BS 6651 recognized a concept of zoning in Annex C, IEC/BS EN 62305-4 defines the concept of Lightning Protection Zones (LPZs). Figure 8 illustrates the basic LPZ concept defined by protection measures against LEMP as detailed within part 4.

Within a structure a series of LPZs are created to have, or identified as already having, successively less exposure to the effects of lightning.

Successive zones use a combination of bonding, shielding and coordinated SPDs to achieve a significant reduction in LEMP severity, from conducted surge currents and transient overvoltages, as well as radiated magnetic field effects. Designers coordinate these levels so that the more sensitive equipment is sited within the more protected zones.

The LPZs can be split into two categories - 1 external zone (LPZ 0) and usually 2 internal zones (LPZ 1, 2) although further zones can be introduced for a further reduction of the electromagnetic field and lightning current if required.

External zones

LPZ 0 is the area subject to direct lightning strokes and therefore may have to carry up to the full lightning current. This is typically the roof area of a structure. The full electromagnetic field occurs here. It also covers the area not subject to direct lightning strokes and typically includes the sidewalls of a structure. However the full electromagnetic field still occurs here and conducted partial lightning currents and switching surges can occur here.

Internal zones

LPZ 1 is the internal area that is subject to partial lightning currents. The conducted lightning currents and/or switching surges are reduced compared with the external zones LPZ 0. This is typically the area where services enter the structure or where the main power switchboard is located.

LPZ 2 is an internal area that is further located inside the structure where the remnants of lightning impulse currents and/or switching surges are reduced compared with LPZ 1. This is typically a screened room or, for mains power, at the sub-distribution board area.

Protection levels within a zone must be coordinated with the immunity characteristics of the equipment to be protected, i.e., the more sensitive the equipment, the more protected the zone required.

The existing fabric and layout of a building may make readily apparent zones, or LPZ techniques may have to be applied to create the required zones.

Figure 13. Basic LPZ concept - IEC/BS EN 62305-4

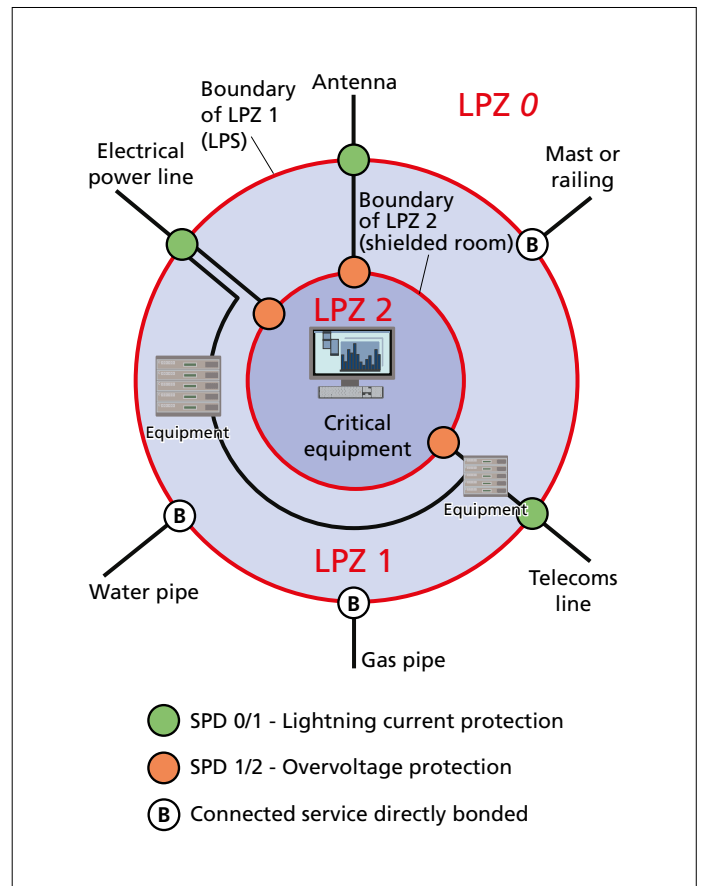

Technical reference

IEC/BS EN 62305-4 - Electrical & electronic systems within structures

Surge Protection Measures (SPM)

Some areas of a structure, such as a screened room, are naturally better protected from lightning than others and it is possible to extend the more protected zones by careful design of the LPS, earth bonding of metallic services such as water and gas, and cabling techniques. However it is the correct installation of coordinated Surge Protective Devices (SPDs) that protect equipment from damage as well as ensuring continuity of its operation - critical for eliminating downtime. These measures in total are referred to as Surge Protection Measures (SPM) (formerly LEMP Protection Measures System (LPMS)).

When applying bonding, shielding and SPDs, technical excellence must be balanced with economic necessity. For new builds, bonding and screening measures can be integrally designed to form part of the complete SPM. However, for an existing structure, retrofitting a set of coordinated SPDs is likely to be the easiest and most cost-effective solution.

Coordinated SPDs

IEC/BS EN 62305-4 emphasizes the use of coordinated SPDs for the protection of equipment within its environment. This simply means a series of SPDs whose locations and LEMP handling attributes are coordinated in such a way as to protect the equipment, by reducing the LEMP effects to

a safe level. So there may be a heavy duty lightning current SPD at the service entrance to handle the majority of the surge energy (partial lightning current from an LPS and/or overhead lines) with the respective transient overvoltage controlled to safe levels by coordinated plus downstream overvoltage SPDs to protect terminal equipment including potential damage by switching sources, e.g. large inductive motors. Appropriate SPDs should be fitted wherever services cross from one LPZ to another.

Coordinated SPDs have to effectively operate together as a cascaded system to protect. For example the lightning current SPD at the service entrance should handle the majority of surge energy, sufficiently relieving the downstream overvoltage SPDs to control the overvoltage.

Poor coordination could mean that the overvoltage SPDs are subject to too much surge energy putting both itself and potentially equipment at risk from damage.

Furthermore, voltage protection levels or let-through voltages of installed SPDs must be coordinated with the insulating withstand voltage of the parts of the installation and the immunity withstand voltage of electronic equipment.



Enhanced SPDs

Whilst outright damage to equipment is not desirable, the need to minimize downtime as a result of loss of operation or malfunction of equipment can also be critical. This is particularly important for industries that serve the public, i.e. hospitals, financial institutions, manufacturing plants or commercial businesses, where the inability to provide a service due to the loss of operation of equipment would result in significant health and safety and/or financial consequences.

Standard SPDs may only protect against common mode surges (between live conductors and earth), providing effective protection against outright damage but not against downtime due to system disruption.

IEC/BS EN 62305 therefore considers the use of enhanced SPDs (SPD*) that further reduce the risk of damage and malfunction to critical equipment where continuous operation is required. Installers will therefore need to be much more aware of the application and installation requirements of SPDs than perhaps they may have been previously.

Superior or enhanced SPDs provide lower (better) let-through voltage protection against surges in both common mode and differential mode (between live conductors) and therefore also provide additional protection over bonding and shielding measures.

Such enhanced SPDs can even offer up to mains Type 1+2+3 or data/telecom Test Cat D+C+B protection within one unit. As terminal equipment, e.g. computers, tends to be more vulnerable to differential mode surges, this additional protection can be a vital consideration.

Furthermore, the capacity to protect against common and differential mode surges permits equipment to remain in continued operation during surge activity - offering considerable benefit to commercial, industrial and public service organisations alike.

All Furse SPDs offer enhanced SPD performance with industry leading low let-through voltages (voltage protection level, U_p), as this is the best choice to achieve cost-effective, maintenance-free repeated protection in addition to preventing costly system downtime. Low let-through voltage protection in all common and differential modes means fewer units are required to provide protection, which saves on unit and installation costs, as well as installation time.

Conclusion

Lightning poses a clear threat to a structure but a growing threat to the systems within the structure due to the increased use and reliance of electrical and electronic equipment. The IEC/BS EN 62305 series of standards clearly acknowledge this. Structural lightning protection can no longer be in isolation from transient overvoltage or surge protection of equipment. The use of enhanced SPDs provides a practical cost-effective means of protection allowing continuous operation of critical systems during LEMP activity.

A Guide to BS EN 62305 Protection Against Lightning

Further to this summary on IEC/BS EN 62305, we have available a comprehensive guide to the BS EN 62305 standard for those interested in learning more about the new developments governing lightning protection design and installation. This A4 Guide helps to explain in clear terms the requirements of BS EN 62305. Following the 4 sections of the standard (Part 1 - General principles; Part 2 - Risk management; Part 3 - Physical damage to structures and life hazard; and Part 4 - Electrical and electronic systems within structures) the Guide provides the information necessary to enable the reader to identify all risks and calculate the required level of protection in accordance with BS EN 62305.

To request your free of charge copy - contact us directly at any of the addresses given on the back cover or visit www.furse.com



Technical reference

IEC/BS EN 62561 series - Lightning protection system components

The IEC/BS EN 62561 series of standards focuses on design and performance of components which are to be installed in an external LPS.

Designers/users of these systems need to be assured that the components, conductors, earth electrodes etc. that will be installed have the requisite durability to survive long term exposure to the environmental elements whilst retaining the ability to dissipate lightning current safely and harmlessly to earth.

The IEC/BS EN 62561 series of standards defines the processes by which these critical lightning protection components are judged fit for purpose.

There are currently seven parts to the series:

- **IEC/BS EN 62561-1** Lightning protection system components (LPSC) Part 1: Requirement for connection components
- **IEC/BS EN 62561-2** Lightning protection system components (LPSC) Part 2: Requirements for conductors and earth electrodes
- **IEC/BS EN 62561-3** Lightning protection system components (LPSC) Part 3: Requirements for isolating spark gaps (ISG)
- **IEC/BS EN 62561-4** Lightning protection system components (LPSC) Part 4: Requirements for conductor fasteners
- **IEC/BS EN 62561-5** Lightning protection system components (LPSC) Part 5: Requirements for earth electrode inspection housings and earth electrode seals
- **IEC/BS EN 62561-6** Lightning protection system components (LPSC) Part 6: Requirements for lightning strike counters
- **IEC/BS EN 62561-7** Lightning protection system components (LPSC) Part 7: Requirements for earth enhancing compounds



Environmental ageing chamber for ammonia atmosphere ageing

Independent testing

IEC/BS EN 62561 series requires manufacturers to undertake thorough testing and performance measurement of their components in order to gain compliance.

Three specimens of the component are tested, with conductors and specimens prepared and assembled in accordance with the manufacturer's instructions, e.g. to recommended tightening torques.

Testing can include environmental preconditioning (various treatments such as salt mist spray or exposure to a humid sulphurous atmosphere etc.) followed by subjecting components to simulated lightning discharges to assess their capacity to cope with onerous conditions.

Environmental preconditioning is designed to rapidly replicate the effect of component ageing under expected environmental conditions at site, to prove the component's ability to conduct lightning over time.

Testing therefore ensures components have been appropriately constructed for their application, meet the requirements of the standard and will prove safe in use for a number of years.

Furse product tests are undertaken by an independent Certified test laboratory - The Research Development and Certification Centre, High Voltage and High Current Testing Laboratory - to ensure our products conform.

Passing the test

Each part of IEC/BS EN 62561 defines its own criteria for satisfactory performance of components.

All three specimens of a tested component must satisfy the conditions set out by IEC/BS EN 62561 in order for the testing to be deemed successful.

Following testing, a full test report with certification should be produced by the independent laboratory for all components satisfying the test criteria.

IEC/BS EN 62561 requires manufacturers to retain the test report along with adequate documentation to support testing and product application, including installation instructions.

Furse component performance

By choosing lightning protection components conforming to the IEC/BS EN 62561 series, the designer ensures he or she is using the best products on the market and is in compliance with IEC/BS EN 62305.

Furse structural lightning protection and earthing components are therefore rigorously tested to this standard.

Through independent testing, Furse products are proven to withstand the constant exposure to the environment as required by an LPS, thereby ensuring they will continue to dissipate lightning current safely and harmlessly to earth over the long term.

All Furse connection components are designed to conform to the IEC/BS EN 62561 test procedures.

Figure 14. Furse lightning protection components, showing results after environmental preconditioning and lightning discharge testing



Technical reference

Earthing standards

Installation of a well designed earthing system is a fundamental requirement for all structures and electrical systems (at all voltages).

Effective earthing safeguards people from risk of electric shock, in that *'hazardous-live-parts shall not be accessible and accessible conductive parts shall not be hazardous live'*, and ensures a low impedance route to the general mass of earth for currents in the electrical system, under both normal and fault conditions.

A number of national and international standards have been published which define earthing system design parameters for structures, electrical equipment and systems, including:

- **BS EN 50522:** Earthing of power installations exceeding 1kVac
- **BS 7430:** Code of practice for protective earthing of electrical installations
- **BS 7354:** Code of practice for design of high voltage open terminal stations
- **IEEE Std 80:** IEEE Guide for safety in AC substation grounding
- **ENA TS 41-24** Guidelines for the design, installation, testing and maintenance of main earthing systems in substations

The design, specification, inspection and periodic testing of earthing systems should follow the guidance and recommendations provided by these standards.

BS 7430: Protective earthing of electrical installations

British Standard BS 7430 provides guidance on earthing of general land-based electrical installations in and around buildings in the UK, including:

- Low voltage installation earthing and equipotential bonding for general, industrial and commercial buildings, locations with increased risk, rail systems etc
- The interface between low voltage and high voltage substations
- Earthing of generators and Uninterruptible Power Supplies (UPSs) supplying low voltage installations

BS 7430 defines the elements for creating an appropriate earthing arrangement for a low voltage installation, including a main earthing terminal, protective conductors, earthing conductors and circuit protective conductors, and the use of earth electrodes to dissipate currents to the general mass of earth. Extending the earthing arrangement through the use of equipotential bonding measures to cover exposed and conductive metal parts is further recommended to protect against step and touch voltages, and to remove risk of dangerous sparking. Five classes of low voltage electrical installation are defined within the standard - TN-S, TN-C, TN-C-S, TT and IT.

Performance requirements for earthing these low voltage installations are defined in the IET Wiring Regulations, BS 7671:2008(+A1:2011).

The earthing arrangement should be sufficiently robust to ensure it lasts the lifetime of the installation, and be protected from mechanical damage and corrosion so that it remains capable of carrying the maximum expected current, it is specified for under both normal and fault conditions.

BS 7430 therefore defines selection parameters for the earthing arrangement, e.g. the size and material for conductors, earth electrodes etc, and makes clear the need for careful consideration of site conditions (soil composition and resistivity).

Taking actual measurements at the site is important to gauge the expected effectiveness of the earthing arrangement, and guidance is provided for measuring resistance calculations for earth plates, earth rods, ring conductor and foundation earth electrodes.

Where necessary in high resistivity areas or on rocky ground, treatment of the soil through use of an earth electrode backfill is recommended to improve earth contact resistance.

Substation earthing

BS 7354, IEEE std. 80 and ENA TS 41-24 reference the requirements for earthing of substations.

The design and specification of an appropriate earthing arrangement for substations is essential to provide a low impedance path for earth fault, and lightning currents, and to protect personnel on site from potentially fatal step and touch voltages. These standards provide guidance on (but not limited to):

- Maximum permitted step and touch voltages
- Methods for calculating earthing system design
- High voltage earth electrode selection, including type, material and size
- Switching and busbar arrangement
- Equipotential bonding
- Insulation co-ordination

Primary to these standards is limiting earth potential rise (EPR) under earth fault conditions so that step and touch potential limits are not exceeded, and earth resistance remains as low as possible. Essentially, use of an earthing grid consisting of horizontal cross-bonded earthing conductors is recommended, augmented by earth rods where the site includes low resistivity layers beneath the surface. These earth rods mitigate seasonal variations in earth grid resistance at the grid's burial depth.

Technical reference

Lightning protection to NFPA & UL standards

Within certain markets installation of an LPS, including component selection, is governed by American NFPA and UL standards rather than their IEC/BS EN equivalent.

The appropriate standards for lightning protection in these markets are:

- UL 96 Lightning Protection Components
- UL 467 Grounding and Bonding Equipment
- NFPA 780 Standard for the Installation of Lightning Protection Systems
- UL 96A Installation Requirements for Lightning Protection Systems

UL 96 and UL 467 are product standards for lightning protection components; NFPA 780 and UL 96A are application standards governing satisfactory installation of an LPS.

UL 96 & UL 467

These standards define the requirements for lightning protection components, including their design, material composition, performance and testing to ensure they are suitable for application in an LPS. UL 96 covers above ground lightning protection components, including:

- Air termination components (air terminals and bases)
- Conductors
- Connector fittings (conductor clips, clamps, bimetallic connectors and bonding plates etc)

Components are divided into 3 Classes, to reflect their intended application (Class I, Class II, Class II modified).

UL 467 covers grounding (UK - earthing) and bonding equipment used to create a grounding system in line with the requirements of NFPA 780. Products include:

- Ground clamps, bushings and fittings
- Grounding electrodes (rods/plates) and ground mesh

Products are determined suitable for use in an LPS following testing and evaluation by UL. Where a product successfully passes UL evaluation it may carry a UL Mark appropriate to the testing carried out.

Installation of lightning protection systems to NFPA 780/UL 96A

Application standards NFPA 780 and UL 96A cover assessment of risk from lightning and installation of an appropriate LPS. Structures to be protected are defined as one of two classes, as follows, which correlates back to the product grade which should be installed:

- **Class I:** buildings less than 75 feet in height
- **Class II:** structures greater than 75 feet in height, and special structures such as heavy duty stacks and steeples

Three options are proposed for the design of air termination systems:

- **Air termination placement:** Air terminals are placed in a grid pattern at intervals of up to 20 or 25 feet (dependent on air terminal height), with a relaxation in the spacing if air terminals are not on the perimeter of the structure (for roof lengths or widths exceeding 50 feet). These spacings
- apply to flat or gently sloping roofs only with more complex roof structures requiring specific design to protect all parts
- **Rolling sphere method:** Similar in principle to IEC/BS EN 62305, though with a single sphere radius of 150 feet. At all times the rolling sphere should only be in contact with the tips of the air terminals and not the fabric of the structure
- **Protective angle method:** Based on the ratio of height/size of a higher building with regard to a lower one. It does not apply for structures over 50 feet in height, where air termination placement or the rolling sphere should be used

Installed air terminals (air rods) should not be less than 10" in length or $\frac{3}{8}$ " in diameter, and where above 24" in height require bracing at minimum half their height.

There should be at least two down conductors from air termination system to the grounding system, which should be secured to the structure with suitable connectors at intervals no more than 3 feet apart.

Air termination and down conductor components can be manufactured from copper, copper alloy or electrical grade aluminium, unless otherwise specified, on the proviso that:

- Copper components should not be in contact with aluminium or external galvanized steel surfaces
- Aluminium products should not be in contact with the earth, be set in concrete or masonry, be installed in wet locations, or be in contact with coated surfaces using alkaline paint

The grounding system for lightning protection should be bonded to all other grounding systems at the structure, including those for power and communication, as well as underground metallic services (utilities etc). The bonding conductor should be the same size as the main down conductor and main system conductor.

Grounding electrodes can be rods or plates. Rods should not be less than $\frac{1}{2}$ " in diameter and 8 feet in length, and should be manufactured from copperbonded steel, solid copper or stainless steel. Grounding arrangements using ringed conductors or steel rebars are also acceptable.

Note: products shown in this catalogue with the UL Mark have been successfully evaluated by UL.

Technical reference

Overvoltage protection to BS 7671

The latest amendment to the 17th Edition of the Wiring Regulations, BS 7671:2008(+A1:2011), in force from January 2012, establishes a requirement for assessing protection against transient overvoltages (surges) as an integral part of satisfactory electrical system design.

BS 7671 assesses the need to protect AC power circuits, although cross-references transient overvoltage protection on other metallic services including data, signal and telecommunications lines, as defined by IEC/BS EN 62305 Standard for Lightning Protection.

It covers transient overvoltages of atmospheric origin (lightning) or as a result of electrical switching, through two sections:

- **Section 443** which defines the criteria for risk assessment of transient overvoltages, considering factors such as levels of consequential loss and the withstand voltage/impulse immunity of installed electronic systems
- **Section 534** which outlines the parameters for selection and installation of SPDs as appropriate, to ensure satisfactory protection of electronic systems and electrical equipment

Risk assessment

Section 443 establishes that protection against transient overvoltages should be expected where:

- An installation includes bare overhead metallic service lines which are at risk from lightning and
- The level of transient overvoltage anticipated would exceed the withstand voltage of sensitive electrical equipment/impulse immunity of critical electrical equipment, or
- The risk of potential consequential loss (to life, property or provision of service) would be unacceptable

Whilst direct lightning strokes are not considered, reference is made to BS EN 62305 which would require installation of equipotential bonding SPDs where a structural LPS is installed, or there is a risk of a direct lightning stroke to a service line.

Factors contributing to risk include external influences (thunderstorm days per year) and consequential levels of protection. Irrespective of external influences, where higher reliability or higher risks are anticipated, protection measures should be installed.

Considering the consequential levels of protection defined by BS 7671, protection is required wherever there is a risk of loss of human life (including permanent injury), to public services and to commercial or industrial activity.

Selection & installation of SPDs

Section 534 provides guidance on the selection and installation of SPDs to limit transient overvoltages.

The selection of an SPD is dependent on its location within the installation, the withstand voltage/impulse immunity of equipment at this location, and the expected transient overvoltage energy that the SPD is required to limit. The largest transient overvoltages are expected at the service entrance, i.e. at the origin of the installation.

Additionally transient overvoltages can be anticipated at sensitive and critical equipment as a result of electrical switching within the installation. SPDs should therefore be installed as appropriate at main distribution board level (after the meter), sub-distribution board level to protect sensitive equipment, and locally to protect critical equipment. Where multiple SPDs are installed on the same conductor, these should coordinate with each other to ensure protection levels are not compromised within the system.

The most important characteristic for an SPD is its voltage protection level (U_p) and not its energy withstand (e.g. I_{imp}). SPDs with lower voltage protection levels (or let-through voltage) offer much better protection to sensitive and critical electronic systems, including:

- Minimal equipment stress (i.e. keeping circuit degradation to a minimum)
- Reduced risk from additive inductive voltages on the SPDs connecting leads
- Reduced risk from downstream voltage oscillations

BS 7671 follows IEC/BS EN 62305 by classifying SPDs by Type. Equipotential bonding SPDs (Type 1) must be installed at the service entrance where a structural LPS is installed or there is an overhead metallic service line at risk from a direct lightning stroke.

Type 1 SPDs however do not provide protection to electronic systems. Transient overvoltage SPDs (Type 2 or Type 3) are required downstream to protect sensitive and critical equipment. These SPDs protect against the transient overvoltages caused by indirect lightning (inductive or resistive coupling) and the electrical switching of large inductive loads.

They should offer Full Mode protection to protect sensitive and critical electronic systems, since transients can occur between all modes. Specific performance parameters for SPDs are defined in BS 7671, which are covered by Furse SPDs in this catalogue when installation follows the selection chart provided in section 11/3. For more information on surge protection to BS 7671, please contact us.

Technical reference

BS EN 61643 standard series

Fursee SPDs meet the performance parameters defined in two national & European standards:

- **BS EN 61643-11** Surge protective devices connected to low-voltage power systems - requirements and tests
- **BS EN 61643-21** Surge protective devices connected to telecommunications and signalling networks - performance requirements and testing methods

These parts of the BS EN 61643 standard apply for all SPDs providing protection against lightning (direct and indirect) and transient overvoltages.

BS EN 61643-11 covers AC mains protection, for 50/60 Hz AC power circuits and equipment rated up to 1000 V_{RMS} AC and 1500 V DC.

BS EN 61643-21 covers telecommunications and signalling networks with nominal system voltages up to 1000 V_{RMS} AC and 1500 V DC.

Within these parts to the standard is defined:

- The electrical requirements for SPDs, including voltage protection and current limiting levels, status indication and minimum test performance
- The mechanical requirements for SPDs, to ensure an appropriate quality of connection, and mechanical stability when mounted
- The safety performance of the SPD, including its mechanical strength and its ability to withstand heat, overstress and insulation resistance

The standard establishes the importance of testing SPDs to determine their electrical, mechanical and safety performance.

Electrical tests include impulse durability, current limiting, and transmission tests. Mechanical and safety tests establish levels of protection against direct contact, water, impact, the SPD installed environment etc.

For voltage and current limiting performance, an SPD is tested according to its Type (or Class to IEC1), which defines the level of lightning current or transient overvoltage it is expected to limit/divert away from sensitive equipment.

Tests include Class I impulse current, Class I & II nominal discharge current, Class I & II voltage impulse and Class III combination wave tests for SPDs installed on power lines, and Class D (high energy), C (fast rate of rise), and B (slow rate of rise) for those on data, signal and telecoms lines.

SPDs are tested with the connections or terminations following manufacturer's instructions, as per the expected SPD installation.

Measurements are taken at the connectors/terminals. Three samples of an SPD are tested and all must pass before approval is granted.

SPDs which have been tested to BS EN 61643 should be suitably labelled and marked, to include the relevant performance data for their application.

Technical specifications

Within BS EN 61643 there are two Technical Specifications which provide recommendations on the selection and installation of SPDs.

These are:

- **DD CLC/TS 61643-12** Surge protective devices connected to low-voltage power systems - selection and application principles
- **DD CLC/TS 61643-22** Surge protective devices connected to telecommunications and signalling networks - selection and application principles

These Technical Specifications should be used with BS EN 61643-11 and BS EN 61643-21 respectively. Each Technical Specification provides information and guidance on:

- Risk assessment and evaluating the need for SPDs in low-voltage systems, with reference to IEC/BS EN 62305 Lightning Protection standard and IEC 60364 Electrical installations for buildings
- Important characteristics of an SPD (e.g. voltage protection level) in conjunction with the protection needs of equipment (i.e. its impulse withstand or impulse immunity)
- Selection of SPDs considering the entire installation environment, including their classification, function and performance
- Coordination of SPDs throughout the installation (for power and data lines) and between SPDs and RCDs or overcurrent protective devices

Through following the guidance in these documents, appropriate specification of SPDs to meet the installation requirement can be achieved.

Technical reference

Lightning protection of hazardous areas to ATEX/IECEx

Many industries, such as petrochemical, oil & gas and pharmaceutical, face the ongoing challenge of protecting people and property from the risk presented by potentially explosive atmospheres.

These atmospheres create hazardous areas, where flammable gases, powders, or dusts have the potential to mix with air at a ratio which would result in an explosion if ignited by a spark or other source of ignition (static charge, chemical reaction etc).

Clearly, lightning presents a significant threat to potentially explosive atmospheres, both through a direct strike, flash over and the risk of partial lightning currents entering the hazardous area via incoming/outgoing metallic services.

The employer or plant operator has responsibility for ensuring safety against potentially explosive atmospheres, and should therefore reference the relevant standards and directives - IEC/BS EN 62305 for lightning protection and ATEX (IECEx outside the EU) for protecting potentially explosive atmospheres - when establishing the requirement for lightning protection on site.

ATEX directives

Two ATEX directives have been published with the aim to protect employees, the public and the environment from accidents owing to explosive atmospheres. They require employers to eliminate or control risks from hazardous areas, to classify areas where explosive atmospheres may occur, and to ensure products suitable for use in those areas are applied.

From July 2006, all existing and new sites where hazardous areas are present must be ATEX compliant.

ATEX 137, Directive 1999/92/EC

This directive covers health and safety of employees at risk from explosive atmospheres. It requires employers to take necessary steps to prevent formation of explosive atmospheres, to avoid ignition in explosive atmospheres where they cannot be fully prevented, and to limit the effects of an explosion should such an event occur.

It further classifies the places where explosive atmospheres may occur into a number of zones (see Table 12).

ATEX Article 100A, Directive 94/9/EC

This directive covers equipment and protective systems for potentially explosive atmospheres and the health and safety requirements to which they must conform.

Table 12: Zonal classification of hazardous areas

Expectation of potentially explosive atmosphere/hazard arising	Zone reference	
	Gas	Dust
Hazard is continuously present, for long periods or frequently (> 1000 hours per year)	Zone 0	Zone 20
Hazard is likely to arise occasionally during normal operation (10-1000 hours per year)	Zone 1	Zone 21
Hazard is not likely to arise during normal operation, or is of short duration only (< 10 hours per year)	Zone 2	Zone 22
No hazard is present	SAFE AREA	

Table 13: Intrinsically Safe product classification

Symbol	Suitable for zones	Category	Standard
Ex ia	0, 1, 2, 20, 21 & 22	1	IEC 60079-11
Ex ib	1, 2, 21 & 22	2	IEC 60079-11

It applies both to equipment and systems used in potentially explosive atmospheres, and those sited outside these atmospheres which contribute to the level of safety in the hazardous area. Equipment is categorized in line with the protection level offered against the risk of producing a spark or source of ignition in a potentially explosive atmosphere.

Categories include:

- Applicable zone and equipment group for gases/vapours (II) or dusts (III)
- Protection level, per zone, according to risk from gases/vapours (Ga; Gb; Gc) or dusts (Da; Db; Dc)
- Form of protection (flameproof enclosure - Exd; Increased Safety - Exe; Intrinsically Safe - Exi etc)
- ILevel of protection to gas/vapour group or dust group (IIA; IIB; IIC)
- Restrictions in product usage (equipment without restriction; equipment with special condition - X; component - U)
- Temperature Class (T1-T6, spanning temperatures from 450 °C down to 85 °C)

Products classified as intrinsically safe (IS) are further categorized according to their applicable zone (see Table 13). Products are tested to ensure compliance with the requirements of ATEX, with approved products marked accordingly based on the classification system, including their ATEX certification number.

Lightning protection of hazardous areas in line with ATEX/IECEX

With hazardous areas at risk from the consequences of direct and indirect lightning, a comprehensive approach to lightning protection in line with IEC/BS EN 62305 should be considered. This should cover structural lightning protection, earthing and equipotential bonding, and transient overvoltage protection. The zonal approach to lightning protection, as established in IEC/BS EN 62305 is applicable for designing an LPS suitable for hazardous areas, considering the following points.

Structural lightning protection

For locations with potentially explosive atmospheres, as defined by IEC/BS EN 62305 the appropriate Class of LPS required shall be dictated by the risk assessment process in IEC/BS EN 62305-2.

An isolated LPS is required since the structure includes combustible materials and/or presents a risk of explosion, with minimum separation distances adhered to between the LPS and structural metallic parts to remove any risk of sparking. Additionally, catenary conductors raised high above the structure should be considered, where these are to protect locations where combustibles are present, such as gas/oil storage tanks.

Earthing & equipotential bonding

The earth termination system should meet the requirements set out in IEC/BS EN 62305-3 a single, integrated earth termination system combining lightning protection, power and telecommunications systems. It should provide low electrical resistance (less than 10 Ohms) and be appropriately bonded to ensure no metallic part is at a different potential with respect to another. Where incoming or outgoing services cannot be bonded directly to earth, these should be protected by a suitable SPD.

Following the zonal approach in IEC/BS EN 62305, services passing from LPZ 0 to LPZ 1 should be protected against partial lightning currents using a lightning current/equipotential bonding SPD (tested to 10/350 μ s waveform), as well as transient overvoltages (SPD tested to 8/20 μ s waveform).

Electronic systems protection

Electrical and electronic equipment/systems need to be protected against transient overvoltages, since damage to components could lead to risk of sparks or fire. Equipment/systems sited in a safe area which do not contribute to safety in a potentially explosive atmosphere can be protected against transient overvoltages using appropriate standard SPDs, as defined by IEC/BS EN 62305.

However, equipment/systems sited in potentially explosive atmospheres (Zone 1, 2) or contributing to safety within these atmospheres require an SPD suitably tested and approved by ATEX. All SPDs installed on site should form a coordinated set to ensure protection levels are maintained and effective throughout.

Protection of intrinsically safe (IS) circuits

Intrinsic Safety (IS) is a concept for protecting hazardous areas from dangerous sparking, whereby sparks from electrical equipment and circuitry are prevented through the use of IS barriers. These barriers limit the available electrical energy that could cause an explosion to below ignition threshold.

IS Barriers however are not surge protectors but are field instruments which are themselves at risk from transient overvoltages. IS circuits therefore need to be protected from transient overvoltages by a suitable (ATEX approved) SPD. Protection should be applied at the boundary between the hazardous and non-hazardous area (see Figure 9), with an isolated screen SPD installed within the hazardous area (Zone 1, 2).

Figure 15: The installed SPD (here the ESP SL30X Series) provides protection for the instrumentation as well as providing protection for the IS Barrier. The isolated screen version (ESP SL30X/I) should be used in Zone 1, 2.

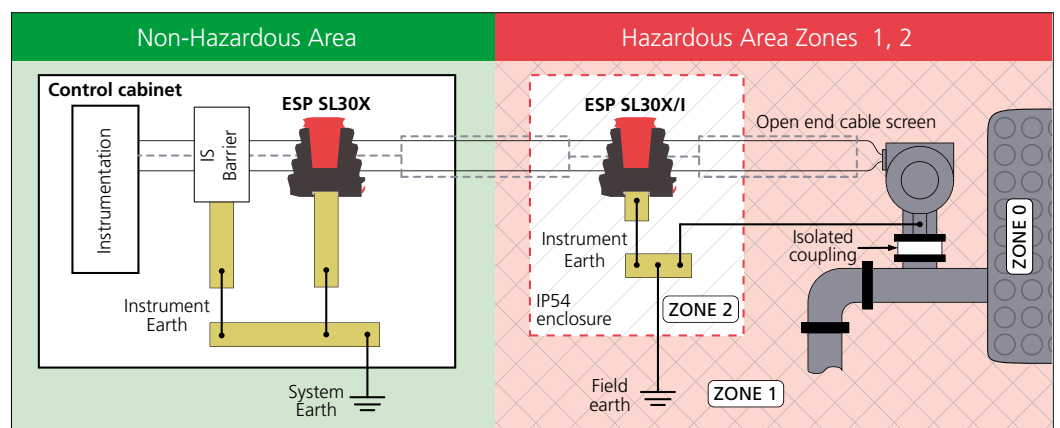

Part number index - earthing & lightning protection

Alphanumeric product list

Part No.	Page No.	Part No.	Page No.	Part No.	Page No.	Part No.	Page No.
3902	8/13	BA231	3/7	BD070-FU	3/9	CB025	3/6
3903	8/13	BA235	3/7	BD070-FU-T	3/9	CB035	3/6
3904	8/13	BA236	3/7	BD095-FU	3/9	CB050-FU	3/6
3907	8/13	BA240	3/7	BD095-FU	3/9	CB070	3/6
3908	8/13	BA241	3/7	BN001	5/23	CB070-T	3/6
103101-FU	4/11	BA250-FU	3/7	BN002	5/23	CB071	3/6
103102-FU	4/11	BA251-FU	3/7	BN005	8/10	CB095	3/6
103103-FU	4/11	BC002	3/7	BN010	8/12	CB120	3/6
103110-FU	4/11	BC003	3/7	BN101	5/23	CB150-FU	3/6
103118-FU	4/11	BC004	3/7	BN102	5/23	CB185	3/6
10H-FU	8/8	BC005	3/7	BN105	8/10	CB240	3/6
1H-FU	8/8	BC006	3/7	BN113	8/10	CB300-FU	3/6
20H-FU	8/8	BC007	3/7	BN114	8/10	CB400-FU	3/6
2H-FU	8/8	BC008	3/7	BN115	8/12	CBB-10-200-7	8/15
30H-FU	8/8	BC009	3/7	BN117	8/10	CBB-10-200-7-T	8/15
350M-FU	8/8	BC010	3/7	BN120	8/12	CBB-10-400-7	8/15
3905-TB	8/13	BC011	3/7	BN125	8/10	CBB-10-400-7-T	8/15
3906-TB	8/13	BC012	3/7	BN130	8/10	CBB-16-200-9	8/15
3909-TB	8/13	BC013	3/7	BN150	8/4	CBB-16-200-9-T	8/15
40H-FU	8/8	BC014	3/7	BN155	8/4	CBB-16-400-9	8/15
499000-FU	4/11	BD006-FU	3/9	BN175	8/13	CBB-16-400-9-T	8/15
499005-FU	4/11	BD006-FU-T	3/9	BN176	8/13	CBB-25-200-11	8/15
499006-FU	4/11	BD010-FU	3/9	BN300-FU	8/10	CBB-25-200-11-T	8/15
499007-FU	4/11	BD010-FU-T	3/9	BN305	8/10	CBB-25-400-11	8/15
499100-FU	4/11	BD016-FU	3/9	BN320	8/10	CBB-25-400-11-T	8/15
499101-FU	4/11	BD016-FU-T	3/9	BN325	8/10	CBB-50-200-11	8/15
4H-FU	8/8	BD020	3/8	BN505	8/14	CBB-50-200-11-T	8/15
8H-FU	8/8	BD020-T	3/8	BN505-T	8/14	CBB-50-400-11	8/15
912000-FU	4/10	BD025	3/8	BN510	8/14	CBB-50-400-11-T	8/15
912001-FU	4/10	BD025-FU	3/9	BN510-T	8/14	CBB-6-200-7	8/15
912002-FU	4/10	BD025-FU-T	3/9	BR005	4/6	CBB-6-200-7-T	8/15
912003-FU	4/10	BD025-T	3/8	BR105	4/6	CBB-6-400-7	8/15
912004-FU	4/10	BD026	3/8	BT150	8/16	CBB-6-400-7-T	8/15
912005-FU	4/10	BD026-T	3/8	BT160	8/16	CBB-70-200-13	8/15
912006-FU	4/10	BD027	3/8	C001	3/7	CBB-70-200-13-T	8/15
912007-FU	4/10	BD027-T	3/8	C005	3/4	CBB-70-400-13	8/15
912008-FU	4/10	BD028	3/8	CA015-FU	5/7	CBB-70-400-13-T	8/15
912009-FU	4/10	BD028-T	3/8	CA020-FU	5/7	CBB-95-200-13	8/15
912010-FU	4/10	BD030	3/8	CA025-FU	5/7	CBB-95-200-13-T	8/15
912011-FU	4/10	BD031	3/8	CA030-FU	5/7	CBB-95-400-13	8/15
912013-FU	4/10	BD031-T	3/8	CA040-FU	5/7	CBB-95-400-13-T	8/15
919828-FU	4/11	BD032	3/8	CA045-FU	5/7	CC016	3/12
AK005	7/9	BD032-T	3/8	CA050-FU	5/7	CC025	3/12
AS100	7/9	BD033	3/8	CA861	5/7	CC035	3/12
AV005	3/14	BD033-T	3/8	CA871	5/7	CC050	3/12
BA205	3/7	BD034	3/8	CA872	5/7	CC070	3/12
BA206	3/7	BD034-T	3/8	CA876	5/7	CC095	3/12
BA210	3/7	BD035	3/8	CA881	5/7	CC120-FU	3/12
BA211	3/7	BD035-FU	3/9	CA886	5/7	CC150-FU	3/12
BA225	3/7	BD035-FU-T	3/9	CA887	5/7	CC185	3/12
BA226	3/7	BD050-FU	3/9	CA900	5/11	CC240	3/12
BA230	3/7	BD050-FU-T	3/9	CB016	3/6	CC300	3/12

Part number index - earthing & lightning protection

Alphanumeric product list

Part No.	Page No.	Part No.	Page No.	Part No.	Page No.	Part No.	Page No.
CC400-FU	3/12	CN2510	8/23	CP205	5/3	CR225	8/4
CD036	3/10	CN2510-T	8/24	CP210-H	5/2	CR230	8/4
CD038	3/10	CN2525	8/23	CP215	5/3	CR305	8/3
CD039	3/10	CN2525-T	8/24	CP215-H	5/2	CR310	8/3
CD040	3/10	CN300120	8/23	CP216	5/3	CR315	8/3
CD041	3/10	CN300120-T	8/24	CP220-H	5/2	CR320	8/3
CD080	3/5	CN300300	8/23	CP225	5/3	CR325	8/3
CD081	3/11	CN300300-T	8/24	CP227	5/3	CR326	8/3
CD083	3/11	CN305	5/21	CP230-H	5/2	CR330	8/3
CD084	3/11	CN310	5/21	CP240-H	5/2	CR505	8/2
CD085	3/11	CN3516	8/23	CP241	5/3	CR510-FU	8/2
CD086	3/11	CN3516-T	8/24	CP245	5/3	CR515	8/2
CD235	3/5	CN3535	8/23	CP256	5/3	CR520	8/2
CG170	7/4	CN3535-T	8/24	CP260-H	5/2	CR525	8/2
CG177	7/5	CN5025	8/23	CP265	5/3	CR700	8/3
CG270	7/4	CN5025-T	8/24	CP305	5/3	CR700	8/3
CG277	7/5	CN5050	8/23	CP405	5/3	CR705	8/3
CG370	7/4	CN5050-T	8/24	CP410	5/3	CR705	8/3
CG377	7/5	CN7025	8/23	CP415	5/3	CR710	8/3
CG500	4/6	CN7025-T	8/24	CP510	5/3	CR730	8/3
CG600	4/6	CN7035	8/23	CP515	5/3	CR730	8/3
CG705	4/6	CN7035-T	8/24	CP517	5/3	CR740	8/3
CG710	4/6	CN7070	8/23	CP805	5/4	CR750	8/3
CM005	5/23	CN7070-T	8/24	CP806	5/4	CR810	5/17
CM015	7/11	CN910	5/22	CP810	5/4	CR815	5/17
CM020	7/11	CN910-UL	5/22	CP815	5/4	CR820	5/17
CM025	7/11	CN915	5/22	CP816	5/4	CR855	5/21
CM030	7/11	CN920	5/22	CP835	5/4	CR860	5/21
CN005	5/19	CN925	5/22	CP855	5/4	CR865	5/21
CN1010	8/23	CN9535	8/23	CP861	5/5	CS350	8/11
CN1010-T	8/24	CN9535-T	8/24	CP871	5/5	CS355	8/11
CN105-H	5/19	CN9570	8/23	CP872	5/5	CS405	5/19
CN120120	8/23	CN9570-T	8/24	CP876	5/5	CS410	5/19
CN120120-T	8/24	CN9595	8/23	CP881	5/5	CS505	5/18
CN150120	8/23	CN9595-T	8/24	CP886	5/5	CS510	5/18
CN150120-T	8/24	CP005	5/5	CP887	5/5	CS605	5/18
CN150150	8/23	CP010	5/5	CP905	5/4	CS610	5/18
CN150150-T	8/24	CP015	5/5	CP910	5/4	CT005-H	5/16
CN1616	8/23	CP020	5/5	CP915	5/4	CT010-H	5/16
CN1616-T	8/24	CP025	5/5	CP915	5/4	CT105-H	5/16
CN185185	8/23	CP030	5/5	CP920	5/4	CT110-H	5/16
CN185185-T	8/24	CP035	5/5	CP925	5/4	CT115-H	5/16
CN18595	8/23	CP040	5/5	CP935	5/4	CT125	5/17
CN18595-T	8/24	CP045	5/5	CR105	8/2	CT130	5/17
CN240120	8/23	CP050	5/5	CR108	8/2	CT135	5/17
CN240120-T	8/24	CP060	5/5	CR110	8/2	CT305	5/20
CN240150	8/23	CP105	5/3	CR115	8/2	CT405	5/20
CN240150-T	8/24	CP110-H	5/2	CR125	8/2	CW015-FU	5/8
CN240185	8/23	CP115	5/3	CR130	8/2	CW020-FU	5/8
CN240185-T	8/24	CP120-H	5/2	CR205	8/4	CW025-FU	5/8
CN240240	8/23	CP125	5/3	CR215	8/4	CW030-FU	5/8
CN240240-T	8/24	CP130	5/3	CR220	8/4	CW040-FU	5/8

Part number index - earthing & lightning protection

Alphanumeric product list

Part No.	Page No.	Part No.	Page No.	Part No.	Page No.	Part No.	Page No.
CW045-FU	5/8	EB1322	8/9	FBB-95-400-13-T	8/14	FP040	5/11
CW050-FU	5/8	EB1331	8/9	FCT12010	8/25	FP045	5/11
CW871	5/8	EB1332	8/9	FCT12012	8/25	FP050	5/11
CW872	5/8	ES300	7/7	FCT12014	8/25	FS005	5/27
CW886	5/8	ES300-12	7/7	FCT12016	8/25	G5	8/2
CW887	5/8	ES300-15	7/7	FCT15010	8/25	G6	8/2
CW905	5/11	ES300-16	7/7	FCT15012	8/25	GC205	3/14
CW999	5/11	ES300-20	7/7	FCT15014	8/25	GC215	3/14
CX005-H	5/16	ES300-34	7/7	FCT15016	8/25	GC220	3/14
CX105-H	5/16	ES300-58	7/7	FCT1610	8/25	GC225	3/14
DET14C	7/12	ES310-03	7/7	FCT1612	8/25	GC230	3/14
DET2/2	7/12	ES310-05	7/7	FCT166	8/25	GD015	5/6
DET3TC	7/12	ES310-10	7/7	FCT168	8/25	GD020	5/6
DET4TD2	7/12	ES310-15	7/7	FCT18512	8/25	GD025	5/6
DL005	5/26	ES310-20	7/7	FCT18514	8/25	GD030	5/6
DL010	5/26	ES310-30	7/7	FCT18516	8/25	GD040	5/6
DT100	5/11	ES320	7/7	FCT24012	8/25	GD045	5/6
EB0000	8/9	FBB-10-200-7	8/14	FCT24014	8/25	GD050	5/6
EB001	8/9	FBB-10-200-7-T	8/14	FCT24016	8/25	GD861	5/6
EB0110	8/9	FBB-10-400-7	8/14	FCT2510	8/25	GD871	5/6
EB0111	8/9	FBB-10-400-7-T	8/14	FCT2512	8/25	GD872	5/6
EB0120	8/9	FBB-120-200-17	8/14	FCT256	8/25	GD876	5/6
EB0121	8/9	FBB-120-200-17-T	8/14	FCT258	8/25	GD881	5/6
EB0130	8/9	FBB-120-400-17	8/14	FCT30012	8/25	GD886	5/6
EB0131	8/9	FBB-120-400-17-T	8/14	FCT30014	8/25	GD887	5/6
EB0211	8/9	FBB-150-200-17	8/14	FCT30016	8/25	HD100	8/26
EB0212	8/9	FBB-150-200-17-T	8/14	FCT3510	8/25	HD200	8/26
EB0221	8/9	FBB-150-400-17	8/14	FCT3512	8/25	HD400	8/26
EB0222	8/9	FBB-150-400-17-T	8/14	FCT356	8/25	HD500	8/26
EB0231	8/9	FBB-16-200-9	8/14	FCT358	8/25	HD600	8/26
EB0232	8/9	FBB-16-200-9-T	8/14	FCT40012	8/25	HD700	8/26
EB0311	8/9	FBB-16-400-9	8/14	FCT40014	8/25	HD800	8/26
EB0312	8/9	FBB-16-400-9-T	8/14	FCT40016	8/25	HF015	5/13
EB0321	8/9	FBB-25-200-11	8/14	FCT5010	8/25	HF020	5/13
EB0322	8/9	FBB-25-200-11-T	8/14	FCT5012	8/25	HF025	5/13
EB0332	8/9	FBB-25-400-11	8/14	FCT506	8/25	HF030	5/13
EB1000	8/9	FBB-25-400-11-T	8/14	FCT508	8/25	HF040	5/13
EB1110	8/9	FBB-50-200-11	8/14	FCT7010	8/25	HF045	5/13
EB1111	8/9	FBB-50-200-11-T	8/14	FCT7012	8/25	HF176	5/13
EB1120	8/9	FBB-50-400-11	8/14	FCT7014	8/25	HF191	5/13
EB1121	8/9	FBB-50-400-11-T	8/14	FCT7016	8/25	HF320	5/14
EB1130	8/9	FBB-6-200-7	8/14	FCT708	8/25	HF325-FU	5/14
EB1131	8/9	FBB-6-200-7-T	8/14	FCT9510	8/25	HF705	5/14
EB1211	8/9	FBB-6-400-7	8/14	FCT9512	8/25	HF710	5/14
EB1212	8/9	FBB-6-400-7-T	8/14	FCT9514	8/25	HF975	5/15
EB1221	8/9	FBB-70-200-13	8/14	FCT9516	8/25	HM005	7/8
EB1222	8/9	FBB-70-200-13-T	8/14	FCT9518	8/25	HM010	7/8
EB1231	8/9	FBB-70-400-13	8/14	FP015	5/11	HM105	7/8
EB1232	8/9	FBB-70-400-13-T	8/14	FP020	5/11	HT010	8/27
EB1311	8/9	FBB-95-200-13	8/14	FP025	5/11	HT020	8/27
EB1312	8/9	FBB-95-200-13-T	8/14	FP030	5/11	HT030	8/27
EB1321	8/9	FBB-95-400-13	8/14	FP035	5/11	HT040	8/28

Part number index - earthing & lightning protection

Alphanumeric product list

Part No.	Page No.	Part No.	Page No.	Part No.	Page No.	Part No.	Page No.
HT050	8/28	LK207-24	8/21	LK245-24	8/19	PS305	5/25
HW015-FU	5/9	LK207-24-T	8/21	LK245-24-T	8/19	PS310	5/25
HW020-FU	5/9	LK207-26	8/21	LK245-26	8/19	PT004	7/9
HW025-FU	5/9	LK207-26-T	8/21	LK245-26-T	8/19	PT005	7/9
HW030-FU	5/9	LK207-28	8/21	LK245-28	8/19	PT006	7/9
HW040-FU	5/9	LK207-28-T	8/21	LK245-28-T	8/19	PT007	7/9
HW045-FU	5/9	LK207-30	8/21	LK245-30	8/19	PT110	7/9
HW050-FU	5/9	LK207-30-T	8/21	LK245-30-T	8/19	PT205	7/9
HW315-FU	5/10	LK207-6	8/21	LK245-6	8/19	PT309-FU	7/9
HW320-FU	5/10	LK207-6-T	8/21	LK245-6-T	8/19	RA015	4/3
HW325-FU	5/10	LK207-8	8/21	LK245-8	8/19	RA025	4/3
HW330-FU	5/10	LK207-8-T	8/21	LK245-8-T	8/19	RA030	4/3
HW340-FU	5/10	LK243-10	8/20	NA005	5/26	RA040	4/3
HW345-FU	5/10	LK243-10-T	8/20	NU165	5/25	RA050	4/3
HW350-FU	5/10	LK243-12	8/20	NU166	5/25	RA080	4/3
HW415-FU	5/10	LK243-12-T	8/20	NU167	5/25	RA085	4/3
HW420-FU	5/10	LK243-14	8/20	NU170	5/25	RA215	4/3
HW425-FU	5/10	LK243-14-T	8/20	NU265	5/25	RA215	4/3
HW430-FU	5/10	LK243-16	8/20	NU266	5/25	RA225	4/3
HW440-FU	5/10	LK243-16-T	8/20	NU267	5/25	RA225	4/3
HW445-FU	5/10	LK243-18	8/20	NU270	5/25	RA230	4/3
HW450-FU	5/10	LK243-18-T	8/20	NU367	5/25	RA230	4/3
HW871	5/9	LK243-20	8/20	NU370	5/25	RA240	4/3
HW872	5/9	LK243-20-T	8/20	PC100-FU	8/6	RA240	4/3
HW886	5/9	LK243-22	8/20	PC101	8/6	RA250-FU	4/3
HW887	5/9	LK243-22-T	8/20	PC102	8/6	RA250-FU	4/3
IN005	8/22	LK243-24	8/20	PC103	8/6	RA400-FU	4/3
IN013	8/22	LK243-24-T	8/20	PC105	8/6	RA402	4/3
IN020	8/22	LK243-26	8/20	PC106	8/6	RA500	4/7
IN030	8/22	LK243-26-T	8/20	PC107	8/6	RA600	4/7
IN040	8/22	LK243-28	8/20	PC108	8/6	RB005	7/5
IN060	8/22	LK243-28-T	8/20	PC110	8/7	RB103	7/5
IN070	8/22	LK243-30	8/20	PC111	8/7	RB105	7/4
JH100	7/9	LK243-30-T	8/20	PC115-FU	8/7	RB107	7/5
LK004	8/22	LK243-6	8/20	PC116	8/7	RB110	7/4
LK004-T	8/22	LK243-6-T	8/20	PC120	8/7	RB115	7/4
LK205	8/22	LK243-8	8/20	PC121	8/7	RB116	7/5
LK205-T	8/22	LK243-8-T	8/20	PC125	8/7	RB125	7/4
LK207-10	8/21	LK245-10	8/19	PC126-FU	8/7	RB126	7/5
LK207-10-T	8/21	LK245-10-T	8/19	PC211	8/7	RB203	7/5
LK207-12	8/21	LK245-12	8/19	PC216	8/7	RB205-FU	7/4
LK207-12-T	8/21	LK245-12-T	8/19	PC221	8/7	RB210	7/4
LK207-14	8/21	LK245-14	8/19	PE005	7/10	RB213	7/5
LK207-14-T	8/21	LK245-14-T	8/19	PE010	7/10	RB215	7/4
LK207-16	8/21	LK245-16	8/19	PE015	7/10	RB216	7/5
LK207-16-T	8/21	LK245-16-T	8/19	PE020	7/10	RB217	7/5
LK207-18	8/21	LK245-18	8/19	PE110	7/10	RB220-FU	7/4
LK207-18-T	8/21	LK245-18-T	8/19	PE120	7/10	RB223	7/5
LK207-20	8/21	LK245-20	8/19	PF005	5/15	RB225	7/4
LK207-20-T	8/21	LK245-20-T	8/19	PF105	5/15	RB226	7/5
LK207-22	8/21	LK245-22	8/19	PL005	4/7	RB235	7/4
LK207-22-T	8/21	LK245-22-T	8/19	PL010	4/7	RB236	7/5

Part number index - earthing & lightning protection

Alphanumeric product list

Part No.	Page No.	Part No.	Page No.	Part No.	Page No.	Part No.	Page No.
RB305	7/4	SC035	5/12	SW010	5/24	TC078	3/4
RB306	7/5	SC040	5/12	SW105	5/24	TC080	3/4
RB310	7/4	SC045	5/12	SW110	5/24	TC082	3/4
RB313	7/5	SC050	5/12	SW305	5/24	TC090	3/4
RB315	7/4	SC105-H	5/12	SW405	5/24	TC092	3/4
RB316	7/5	SC110-H	5/12	SX450	8/11	TC094	3/4
RB317	7/5	SC210-H	5/12	SX455	8/11	TC096	3/4
RB320-FU	7/4	SC215-H	5/12	TA005	3/5	TC098	3/4
RB323	7/5	SD003-H	4/4	TA020	3/5	TC099	3/4
RB325	7/4	SD005	4/4	TA030	3/5	TC100	3/10
RB326	7/5	SD007	4/4	TA040	3/5	TC105-FU	3/10
RB335	7/4	SD015	4/5	TA042	3/5	TC105/50	3/10
RB336	7/5	SD105-H	4/4	TA068	3/5	TC110	3/10
RC010	7/6	SD115	4/5	TA080	3/5	TC110/50	3/10
RC010-KIT	7/6	SD120	4/4	TA100	3/11	TC111-FU	3/12
RC011	7/6	SD155	4/5	TA104	3/11	TC111/50	3/12
RC012	7/6	SD160	4/5	TA105	3/11	TC115-FU	3/10
RC015	7/6	SD165	4/5	TA110	3/11	TC115/50	3/10
RC015-KIT	7/6	SD305	4/4	TA115	3/11	TC120-FU	3/10
RC016	7/6	SD307	4/4	TA120	3/11	TC120/50	3/10
RC017	7/6	SK010	8/17	TA125	3/11	TC125-FU	3/10
RC16-087095	8/5	SK020	8/17	TA130	3/11	TC125/50	3/10
RC20-087095	8/5	SK030	8/17	TA140	3/11	TC130	3/10
RC25-087095	8/5	SK040	8/17	TC010	3/4	TC130/50	3/10
RC25-087095	8/5	SM005	4/7	TC015	3/4	TC140-FU	3/10
RC32-087095	8/5	SM010	4/7	TC020	3/4	TC145	3/10
RC40-087095	8/5	SP100	7/4	TC020/100	3/4	TC220	3/6
RC812-0850	8/5	SP200	7/4	TC025	3/4	TC225-FU	3/6
RR1616	8/5	SP300	7/4	TC026	3/4	TC226	3/6
RR2121	8/5	SS140	5/24	TC030	3/4	TC230	3/6
RR2626	8/5	SS145	5/24	TC030-UL	3/4	TC230-UL	3/6
RR3232	8/5	SS150	5/24	TC030/50	3/4	TC239	3/6
RR3838	8/5	SS155	5/24	TC035	3/4	TC240	3/6
RR812	8/5	SS160	5/24	TC039	3/4	TC245	3/6
RS005	7/6	SS165	5/24	TC040	3/4	TC260	3/6
RS005-KIT	7/6	SS235	5/24	TC040-UL	3/4	TC266	3/6
RS011	7/6	SS240	5/24	TC042	3/4	TC267	3/6
RS012	7/6	SS245	5/24	TC043	3/4	TC280	3/6
RS016	7/6	SS250	5/24	TC044	3/4	TC330	3/13
RS016	7/6	SS255	5/24	TC045	3/4	TC910	3/13
RV005	5/25	SS260	5/24	TC048	3/4	TC910/50	3/13
RV010	5/25	SS635	5/24	TC050	3/4	TC940	3/13
RV105	5/25	SS640	5/24	TC055	3/4	TC980	3/13
RV110	5/25	SS650	5/24	TC060-FU	3/4	TD005	5/27
RX005	8/16	SS655	5/24	TC065	3/4	TP120-FU	5/26
SA105	5/27	ST100	7/4	TC066	3/4	WR165	5/26
SA115	5/27	ST107	7/5	TC067	3/4	WR167	5/26
SC005-H	5/12	ST200	7/4	TC068	3/4	WR170	5/26
SC015	5/12	ST207	7/5	TC069	3/4	WR175	5/26
SC020	5/12	ST300	7/4	TC070	3/4	WR265	5/26
SC025	5/12	ST307	7/5	TC071	3/4	WR266	5/26
SC030	5/12	SW005	5/24	TC075	3/4	WR267	5/26

Part number index - earthing & lightning protection

Alphanumeric product list

Part No.	Page No.
WR270	5/26
WR365	5/26
WR367	5/26
WR370	5/26
WS265	5/25
WS266	5/25
WS267	5/25
WS270	5/25
WS365	5/25
WS367	5/25
WS370	5/25

Part number index - FurseWELD

Alphanumeric product list

Part No.	Page No.	Part No.	Page No.
B135	9/53	HCPK3A	9/52
BB1	9/8	HCPK3B	9/52
BB14	9/11	HCPK4	9/52
BB3	9/9	HCPK4A	9/52
BB41	9/12	HCPK5	9/52
BB7	9/10	HCPK7	9/52
BCM	9/53	HCPK8	9/52
BFC	9/53	HD35-HD150	9/53
BR1	9/16	LC101-FU	9/50
BR2	9/18	LC102-FU	9/50
BR7	9/20	LC103-FU	9/50
BS1	9/13	LC104-FU	9/50
BS2	9/14	LC105-FU	9/50
BS3	9/15	LC106-FU	9/50
CB1	9/22	LC107-FU	9/50
CB4	9/23	LC108-FU	9/50
CB5	9/24	LC109-FU	9/50
CC1	9/25	LC110-FU	9/50
CC11	9/30	LO101	9/51
CC14	9/31	LO102-FU	9/51
CC2	9/26	LO103-FU	9/51
CC4	9/27	LO104	9/51
CC6	9/28	LO105	9/51
CC7	9/29	LO106	9/51
CR1	9/32	LO107	9/51
CR17	9/35	LO108	9/51
CR2	9/33	LO109	9/51
CR24	9/36	LO110	9/51
CR3	9/34	LS101-FU	9/50
CRE1	9/37	LS102-FU	9/50
CRE17	9/41	LS103-FU	9/50
CRE2	9/38	LS104-FU	9/50
CRE3	9/39	LS105-FU	9/50
CRE6	9/40	LS106-FU	9/50
CS1	9/41	LS107-FU	9/50
CS2	9/41	LS108-FU	9/50
CS25	9/44	LS109-FU	9/50
CS27	9/44	LS110-FU	9/50
CS3	9/42	MJ4	9/53
CS32	9/45	MJ5	9/53
CS34	9/46	PACK-A	9/53
CS7	9/42	RS1	9/47
CS8	9/43	RS2	9/47
CS9	9/43	S102-S111	9/53
DUXSEAL	9/53	S108A-S111A	9/53
F1-FU	9/52	SS1	9/49
F2-FU	9/52	SS2	9/49
FGUN	9/53	STM1-FU	9/53
FLINTS	9/53	TB100-FU	9/53
HCPK1	9/52	TK100	9/53
HCPK2	9/52	TK200	9/53
HCPK3	9/52		

Part number index - electronic systems protection

Alphanumeric product list

Part No.	Page No.	ABB order code	Part No.	Page No.	ABB order code	Part No.	Page No.	ABB order code
CME 16	15/3	7TCA085410R0002	ESP 277 D1	11/8-11/9	7TCA085460R0096	ESP CATV/F	14/12-14/13	7TCA085400R0122
CME 32	15/3	7TCA085410R0003	ESP 277 M1	11/14-11/15	7TCA085460R0097	ESP CCTV/B	14/14-14/15	7TCA085400R0123
CME 4	15/3	7TCA085400R0001	ESP 277-16A	11/22-11/23	7TCA085460R0093	ESP CCTV/B-15V	14/14-14/15	7TCA085400R0124
CME 8	15/3	7TCA085400R0002	ESP 277-16A/BX	11/22-11/23	7TCA085460R0094	ESP CCTV/B-30V	14/14-14/15	7TCA085400R0125
ESP 06D	12/4-12/5	7TCA085400R0079	ESP 277-5A	11/22-11/23	7TCA085460R0095	ESP CCTV/B-50V	14/14-14/15	7TCA085400R0126
ESP 06D/2BX	12/10-12/11	7TCA085400R0080	ESP 277-5A/BX	11/22-11/23	7TCA085460R0348	ESP CCTV/T	14/14-14/15	7TCA085400R0129
ESP 06D/BX	12/10-12/11	7TCA085400R0081	ESP 277D-10A	11/20-11/21	7TCA085460R0319	ESP CCTV/T-15V	14/14-14/15	7TCA085400R0270
ESP 06E	12/6-12/7	7TCA085400R0275	ESP 277D-32A	11/20-11/21	7TCA085460R0320	ESP CCTV/T-30V	14/14-14/15	7TCA085400R0271
ESP 06H	12/8-12/9	7TCA085400R0003	ESP 277DS-10A	11/20-11/21	7TCA085460R0321	ESP CCTV/T-50V	14/14-14/15	7TCA085400R0027
ESP 06Q	12/20-12/21	7TCA085400R0087	ESP 277DS-32A	11/20-11/21	7TCA085460R0324	ESP CE10	15/5	7TCA085460R0030
ESP 110D	12/4-12/5	7TCA085400R0005	ESP 30D	12/4-12/5	7TCA085400R0099	ESP CE13	15/5	7TCA085460R0031
ESP 110D/2BX	12/10-12/11	7TCA085460R0343	ESP 30D/2BX	12/10-12/11	7TCA085400R0100	ESP CE7	15/5	7TCA085460R0032
ESP 110D/BX	12/10-12/11	7TCA085400R0006	ESP 30D/BX	12/10-12/11	7TCA085400R0101	ESP CE9	15/5	7TCA085460R0033
ESP 110E	12/6-12/7	7TCA085400R0007	ESP 30E	12/6-12/7	7TCA085400R0104	ESP DC1000/12.5/PV	14/8-14/9	7TCA085460R0146
ESP 110H	12/8-12/9	7TCA085400R0008	ESP 30H	12/8-12/9	7TCA085400R0011	ESP DC550/12.5/PV	14/8-14/9	7TCA085460R0147
ESP 110Q	12/20-12/21	7TCA085400R0088	ESP 30Q	12/20-12/21	7TCA085400R0107	ESP ISDN/RJ45-4/8	13/4-13/5	7TCA085460R0170
ESP 12 DC	11/18-11/19	7TCA085460R0073	ESP 36 DC	11/20-11/21	7TCA085460R0100	ESP ISDN/RJ45-8/8	13/4-13/5	7TCA085460R0171
ESP 120 D1	11/8-11/9	7TCA085460R0069	ESP 415 D1	11/10-11/11	7TCA085460R0105	ESP K10T1	13/6-13/7	7TCA085400R0130
ESP 120 M1	11/14-11/15	7TCA085460R0070	ESP 415 M1	11/14-11/15	7TCA085460R0112	ESP K10T1/PTC	13/6-13/7	7TCA085400R0131
ESP 120-16A	11/22-11/23	7TCA085460R0064	ESP 415 M1R	11/16-11/17	7TCA085460R0115	ESP K10T2	13/6-13/7	7TCA085400R0133
ESP 120-16A/BX	11/22-11/23	7TCA085460R0065	ESP 415 M2	11/12-11/13	7TCA085460R0119	ESP KS06	12/22-12/23	7TCA085400R0029
ESP 120-5A	11/22-11/23	7TCA085460R0066	ESP 415 M2R	11/16-11/17	7TCA085460R0123	ESP KS15	12/22-12/23	7TCA085400R0030
ESP 120-5A/BX	11/22-11/23	7TCA085460R0067	ESP 415 M4	11/12-11/13	7TCA085460R0124	ESP KS30	12/22-12/23	7TCA085400R0032
ESP 120D-10A	11/20-11/21	7TCA085460R0328	ESP 415 M4R	11/16-11/17	7TCA085460R0126	ESP KS50	12/22-12/23	7TCA085400R0033
ESP 120D-32A	11/20-11/21	7TCA085460R0327	ESP 415/I/TNC	11/6-11/7	7TCA085460R0024	ESP KT1	13/6-13/7	7TCA085400R0135
ESP 120DS-10A	11/20-11/21	7TCA085460R0326	ESP 415/I/TNS	11/6-11/7	7TCA085460R0101	ESP KT1/PTC	13/6-13/7	7TCA085400R0034
ESP 120DS-32A	11/20-11/21	7TCA085460R0325	ESP 415/I/TT	11/6-11/7	7TCA085460R0102	ESP KT2	13/6-13/7	7TCA085400R0136
ESP 15D	12/4-12/5	7TCA085400R0089	ESP 415/III/TNC	11/6-11/7	7TCA085460R0025	ESP LA-15/15	13/10-13/11	7TCA085400R0137
ESP 15D/2BX	12/10-12/11	7TCA085400R0090	ESP 415/III/TNS	11/6-11/7	7TCA085460R0103	ESP LA-25/25	13/10-13/11	7TCA085400R0138
ESP 15D/BX	12/10-12/11	7TCA085400R0091	ESP 415/III/TT	11/6-11/7	7TCA085460R0026	ESP LA-5/25	13/10-13/11	7TCA085400R0139
ESP 15E	12/6-12/7	7TCA085400R0095	ESP 48 DC	11/18-11/19	7TCA085460R0142	ESP LA-9/9	13/10-13/11	7TCA085400R0140
ESP 15H	12/8-12/9	7TCA085400R0009	ESP 480 D1	11/10-11/11	7TCA085460R0133	ESP LB-15/15	13/10-13/11	7TCA085400R0141
ESP 15Q	12/20-12/21	7TCA085400R0098	ESP 480 M1	11/14-11/15	7TCA085460R0136	ESP LB-25/25	13/10-13/11	7TCA085400R0142
ESP 208 D1	11/10-11/11	7TCA085460R0077	ESP 480 M1R	11/16-11/17	7TCA085460R0137	ESP LB-9/9	13/10-13/11	7TCA085400R0143
ESP 208 M1	11/14-11/15	7TCA085460R0078	ESP 480 M2	11/12-11/13	7TCA085460R0138	ESP LN	13/12-13/13	7TCA085400R0145
ESP 24 DC	11/18-11/19	7TCA085460R0091	ESP 480 M2R	11/16-11/17	7TCA085460R0139	ESP LN-16/16	13/12-13/13	7TCA085400R0146
ESP 240 D1	11/8-11/9	7TCA085460R0086	ESP 480 M4	11/12-11/13	7TCA085460R0140	ESP LN-4	13/12-13/13	7TCA085400R0147
ESP 240 M1	11/14-11/15	7TCA085460R0089	ESP 480 M4R	11/16-11/17	7TCA085460R0340	ESP LN-8	13/12-13/13	7TCA085400R0148
ESP 240-16A	11/22-11/23	7TCA085460R0080	ESP 50D	12/4-12/5	7TCA085400R0109	ESP LN-8/16	13/12-13/13	7TCA085400R0149
ESP 240-16A/BX	11/22-11/23	7TCA085460R0081	ESP 50D/2BX	12/10-12/11	7TCA085400R0111	ESP MATV/F	14/12-14/13	7TCA085450R0000
ESP 240-5A	11/22-11/23	7TCA085460R0083	ESP 50D/BX	12/10-12/11	7TCA085400R0113	ESP MC	11/24-11/25	7TCA085430R0003
ESP 240-5A/BX	11/22-11/23	7TCA085460R0084	ESP 50E	12/6-12/7	7TCA085400R0116	ESP MC/Cat-5e	11/24-11/25	7TCA085430R0004
ESP 240/I/TNC	11/4-11/5	7TCA085460R0018	ESP 50H	12/8-12/9	7TCA085400R0012	ESP MC/TN/RJ11	11/24-11/25	7TCA085430R0005
ESP 240/I/TNS	11/4-11/5	7TCA085460R0019	ESP 50Q	12/20-12/21	7TCA085400R0118	ESP PCB/06D	12/24-12/25	7TCA085400R0038
ESP 240/I/TT	11/4-11/5	7TCA085460R0020	ESP 690/12.5/WT	14/6-14/7	7TCA085460R0027	ESP PCB/06E	12/26-12/27	7TCA085400R0039
ESP 240/III/TNC	11/4-11/5	7TCA085460R0021	ESP 690/25/WT	14/6-14/7	7TCA085460R0028	ESP PCB/110D	12/24-12/25	7TCA085400R0040
ESP 240/III/TNS	11/4-11/5	7TCA085460R0022	ESP Cat-5e	13/8-13/9	7TCA085400R0017	ESP PCB/110E	12/26-12/27	7TCA085400R0041
ESP 240/III/TT	11/4-11/5	7TCA085460R0023	ESP Cat-5e/PoE	13/8-13/9	7TCA085400R0021	ESP PCB/15D	12/24-12/25	7TCA085400R0042
ESP 240D-10A	11/20-11/21	7TCA085460R0323	ESP Cat-6	13/8-13/9	7TCA085400R0023	ESP PCB/15E	12/26-12/27	7TCA085400R0153
ESP 240D-32A	11/20-11/21	7TCA085460R0322	ESP Cat-6/PoE	13/8-13/9	7TCA085400R0024	ESP PCB/30D	12/24-12/25	7TCA085400R0154
ESP 240DS-10A	11/20-11/21	7TCA085460R0317	ESP CAT5e/UTP-1	15/4	7TCA085400R0022	ESP PCB/30E	12/26-12/27	7TCA085400R0043
ESP 240DS-32A	11/20-11/21	7TCA085460R0318	ESP CAT6/STP-1	15/4	7TCA085400R0231	ESP PCB/50D	12/24-12/25	7TCA085400R0155

Part number index - electronic systems protection

Alphanumeric product list

Part No.	Page No.	ABB order code	Part No.	Page No.	ABB order code	Part No.	Page No.	ABB order code
ESP PCB/50E	12/26-12/27	7TCA085400R0156	ESP RS485	12/30-12/31	7TCA085400R0191	ESP SSI/140AC	14/10-14/11	7TCA085460R0060
ESP PCB/TN	12/24-12/25	7TCA085400R0157	ESP RS485Q	12/30-12/31	7TCA085400R0192	ESP SSI/B	14/10-14/11	7TCA085400R0166
ESP PTE002	15/5	7TCA085400R0055	ESP RTD	12/28-12/29	7TCA085460R0157	ESP SSI/M	14/10-14/11	7TCA085400R0168
ESP RDU D1R/208	15/4	7TCA085400R0282	ESP RTDQ	12/28-12/29	7TCA085400R0158	ESP TN	12/4-12/5	7TCA085400R0171
ESP RDU D1R/415	15/4	7TCA085460R0055	ESP SL RS485	12/30-12/31	7TCA085400R0193	ESP TN/2BX	12/10-12/11	7TCA085400R0172
ESP RDU D1R/480	15/4	7TCA085400R0283	ESP SL RS485/B	15/5	7TCA085400R0262	ESP TN/BX	12/10-12/11	7TCA085400R0175
ESP RDU D1R/LCD/208	15/4	7TCA085460R0345	ESP SL RTD	12/28-12/29	7TCA085400R0232	ESP TN/JP	13/4-13/5	7TCA085400R0177
ESP RDU D1R/LCD/415	15/4	7TCA085460R0346	ESP SL TN	12/12-12/13	7TCA085400R0195	ESP TN/RJ11-2/6	13/4-13/5	7TCA085400R0178
ESP RDU D1R/LCD/480	15/4	7TCA085460R0347	ESP SL 3W/B	15/5	7TCA085400R0260	ESP TN/RJ11-4/6	13/4-13/5	7TCA085400R0179
ESP RDU-SEAL	15/4	7TCA085460R0150	ESP SL/B	15/5	7TCA085400R0194	ESP TN/RJ11-6/6	13/4-13/5	7TCA085400R0180
ESP RDU/415M1R	15/4	7TCA085460R0151	ESP SL/I/B	15/5	7TCA085400R0261	ESP TNQ	12/20-12/21	7TCA085400R0183
ESP RDU/415M2R	15/4	7TCA085460R0152	ESP SLO6	12/12-12/13	7TCA085400R0058	ESP TV/EURO	14/12-14/13	7TCA085450R0027
ESP RDU/415M4R	15/4	7TCA085460R0334	ESP SLO6/3W	12/18-12/19	7TCA085400R0238	ESP TV/F	14/12-14/13	7TCA085450R0028
ESP RDU/480M1R	15/4	7TCA085460R0296	ESP SL110	12/12-12/13	7TCA085400R0061	WBX 16/2/G	15/2	7TCA085410R0020
ESP RDU/480M2R	15/4	7TCA085400R0281	ESP SL110/3W	12/18-12/19	7TCA085400R0266	WBX 2/G	15/2	7TCA085410R0022
ESP RDU/480M4R	15/4	7TCA085400R0239	ESP SL15	12/12-12/13	7TCA085460R0063	WBX 3	15/2	7TCA085410R0023
ESP RF 111A11	14/18-14/19	7TCA085450R0007	ESP SL15/3W	12/18-12/19	7TCA085400R0269	WBX 3/G	15/2	7TCA085410R0024
ESP RF 111121	14/16-14/17	7TCA085450R0002	ESP SL15X	12/14-12/15	7TCA085400R0065	WBX 4	15/2	7TCA085410R0027
ESP RF 111221	14/16-14/17	7TCA085450R0003	ESP SL15X/M	15/5	7TCA085400R0250	WBX 4/GS	15/2	7TCA085410R0028
ESP RF 111321	14/16-14/17	7TCA085450R0004	ESP SL15XL/M	15/5	7TCA085400R0257	WBX 8	15/2	7TCA085410R0030
ESP RF 111421	14/16-14/17	7TCA085450R0005	ESP SL30	12/12-12/13	7TCA085400R0067	WBX 8/GS	15/2	7TCA085410R0031
ESP RF 111521	14/16-14/17	7TCA085450R0006	ESP SL30/3W	12/18-12/19	7TCA085400R0268	WBX D4	15/2	7TCA085410R0032
ESP RF 111621	14/16-14/17	7TCA085450R0057	ESP SL30L/4-20	12/16-12/17	7TCA085400R0070	WBX D8	15/2	7TCA085410R0033
ESP RF 441A11	14/18-14/19	7TCA085450R0014	ESP SL30L/4-20/M	15/5	7TCA085400R0164	WBX M2	15/2	7TCA085410R0034
ESP RF 441121	14/16-14/17	7TCA085450R0010	ESP SL30X	12/14-12/15	7TCA085400R0071	WBX M4	15/2	7TCA085410R0035
ESP RF 441221	14/16-14/17	7TCA085450R0011	ESP SL30X/M	15/5	7TCA085400R0252			
ESP RF 441321	14/16-14/17	7TCA085450R0012	ESP SL30XL/M	15/5	7TCA085400R0253			
ESP RF 441421	14/16-14/17	7TCA085450R0058	ESP SL50	12/12-12/13	7TCA085400R0074			
ESP RF 441521	14/16-14/17	7TCA085450R0059	ESP SL50/3W	12/18-12/19	7TCA085400R0267			
ESP RF 441621	14/16-14/17	7TCA085450R0013	ESP SLRS485/M	15/5	7TCA085400R0259			
ESP RF AA1A11	14/18-14/19	7TCA085450R0016	ESP SLRTD/B	15/5	7TCA085400R0263			
ESP RF AA1121	14/16-14/17	7TCA085450R0060	ESP SLRTD/M	15/5	7TCA085400R0258			
ESP RF AA1221	14/16-14/17	7TCA085450R0015	ESP SLTN/M	15/5	7TCA085400R0241			
ESP RF AA1321	14/16-14/17	7TCA085400R0286	ESP SLX/B	15/5	7TCA085400R0242			
ESP RF AA1421	14/16-14/17	7TCA085450R0061	ESP SLX/I/B	15/5	7TCA085400R0285			
ESP RF AA1521	14/16-14/17	7TCA085450R0062	ESP SLO6/M	15/5	7TCA085400R0243			
ESP RF AA1621	14/16-14/17	7TCA085400R0287	ESP SL15/M	15/5	7TCA085400R0198			
ESP RF BK2	15/5	7TCA085450R0018	ESP SL30/M	15/5	7TCA085400R0197			
ESP RF BK3	15/5	7TCA085450R0020	ESP SL50/M	15/5	7TCA085400R0254			
ESP RF BK4	15/5	7TCA085450R0046	ESP SL110/M	15/5	7TCA085400R0245			
ESP RF GDT-2	15/5	7TCA085450R0052	ESP SLO6L/M	15/5	7TCA085400R0240			
ESP RF GDT-3	15/5	7TCA085450R0053	ESP SL15L/M	15/5	7TCA085400R0249			
ESP RF GDT-4	15/5	7TCA085450R0054	ESP SL30L/M	15/5	7TCA085400R0199			
ESP RF GDT-5	15/5	7TCA085450R0055	ESP SL50L/M	15/5	7TCA085400R0256			
ESP RF GDT-6	15/5	7TCA085450R0056	ESP SL110L/M	15/5	7TCA085400R0248			
ESP RF GDT-A	15/5	7TCA085450R0029	ESP SLO6/3W/M	15/5	7TCA085400R0244			
ESP RLA HD-1	15/4	7TCA085460R0304	ESP SL15/3W/M	15/5	7TCA085400R0247			
ESP RLA HD-2	15/4	7TCA085460R0305	ESP SL30/3W/M	15/5	7TCA085400R0251			
ESP RLA HD-4	15/4	7TCA085460R0156	ESP SL50/3W/M	15/5	7TCA085400R0255			
ESP RLA-1	15/4	7TCA085460R0153	ESP SL110/3W/M	15/5	7TCA085400R0246			
ESP RLA-2	15/4	7TCA085460R0154	ESP SMATV/F	14/12-14/13	7TCA085450R0026			
ESP RLA-4	15/4	7TCA085460R0155	ESP SSI/120AC	14/10-14/11	7TCA085460R0059			

Contact us

ABB Furse

UK Office

Wilford Road
Nottingham
NG2 1EB

Tel: +44 (0) 115 964 3700
Fax: +44 (0) 115 986 0071
Sales Tel: +44 (0) 333 999 9900
Sales Fax: +44 (0) 333 999 9901
E-Mail: enquiry@furse.com

Thomas & Betts Ltd. Br.

A Member of the ABB Group

Middle East Sales Office

Office 724 6WA West Wing
Dubai Airport Free Zone
PO Box 54567
Dubai

United Arab Emirates
Tel: +971 (0)4 609 1635
Fax: +971 (0)4 609 1636
E-mail: furseenquiry@tnb.com

Thomas & Betts (Saudi Arabia)

KSA Office

Building 128

Dammam Industrial Area #2

PO Box 514

Al Khobar 31952

Saudi Arabia

Tel: +966 13 812 1222
Fax: +966 13 812 1175
E-mail: furseenquiry@tnb.com

Thomas & Betts Asia (Singapore) Pte Ltd.

A Member of the ABB Group

c/o ABB Pte Ltd

2 Ayer Rajah Crescent

Level 4

Singapore 139935

Tel: +65 6776 5711
Fax: +65 6778 0222
E-mail: asia.inquiry@tnb.com

www.furse.com

Note: We reserve the right to make technical changes or modify the contents of this document without prior notice. With regard to purchase orders, the agreed particulars shall prevail. ABB AG does not accept any responsibility whatsoever for potential errors or possible lack of information in this document.

We reserve all rights in this document and in the subject matter and illustrations contained therein. Any reproduction, disclosure to third parties or utilization of its contents – in whole or in parts – is forbidden without prior written consent of ABB AG.

Copyright © 2015 ABB
All rights reserved